

GLOBO

FAN

WWW.globo-lighting.com

03628/03628B

Frequency Bandwidth	Max. Transmit power
2.402GHz-2.483GHz	8dBm

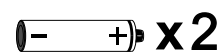
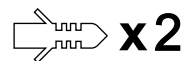
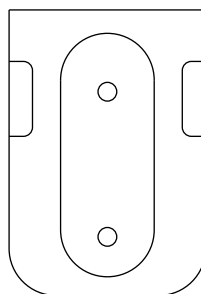
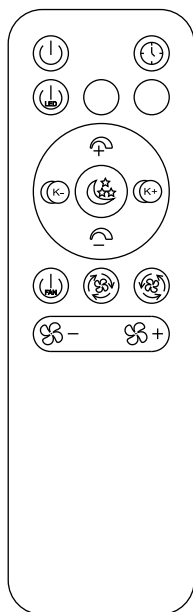
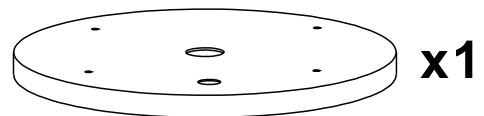
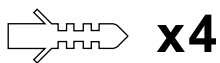
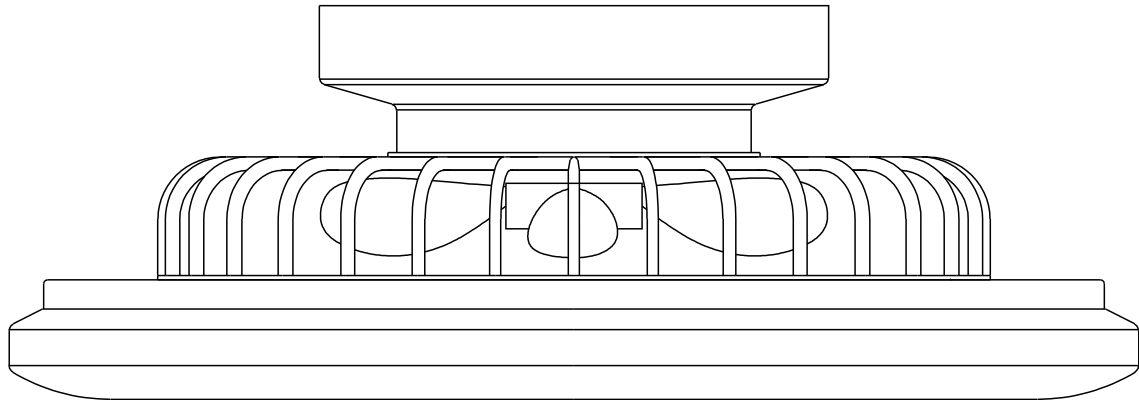

GLOBO Handels GmbH

Gewerbestr. 3
A-9184 Sankt Peter AUSTRIA



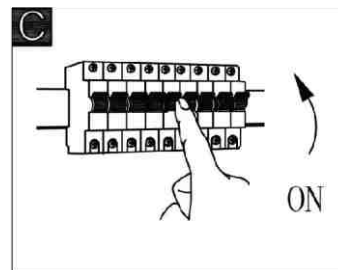
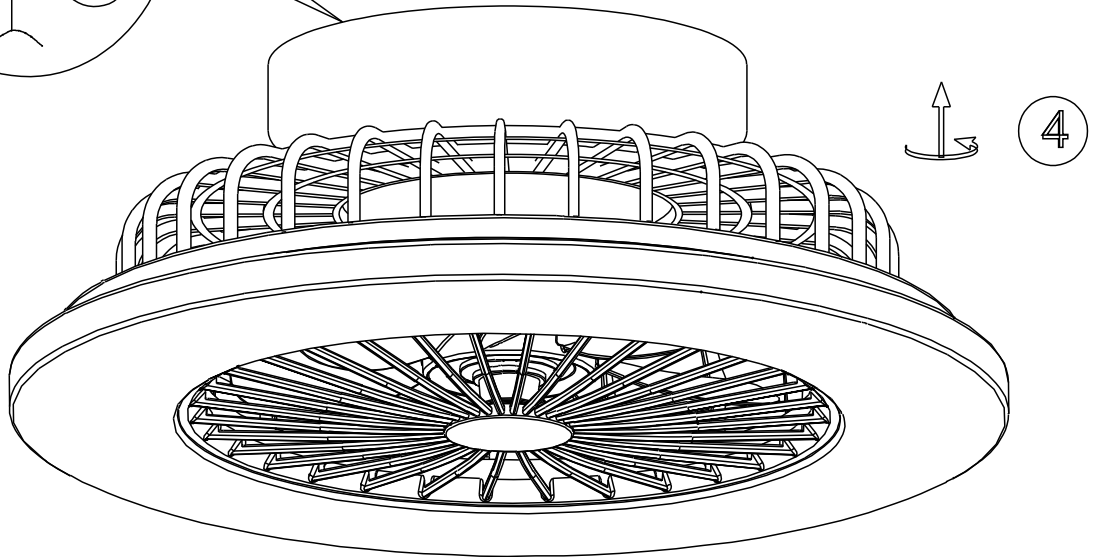
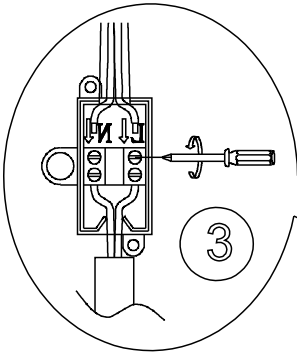
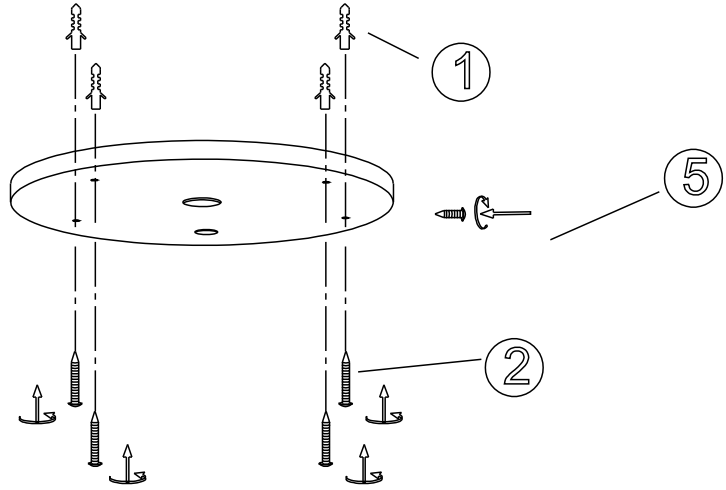
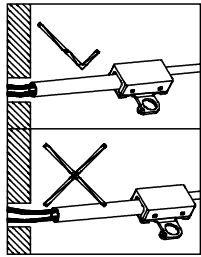
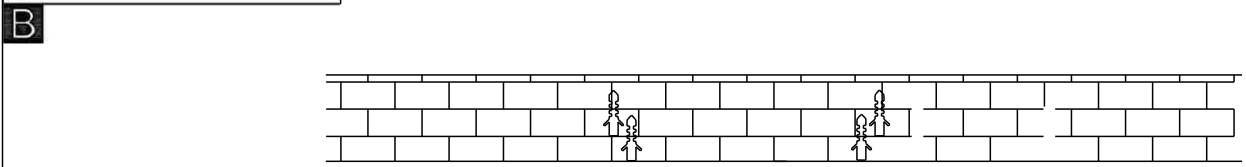
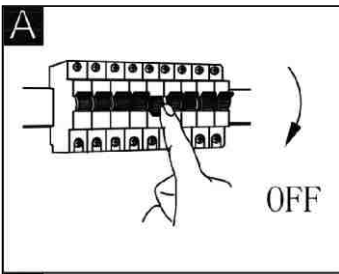

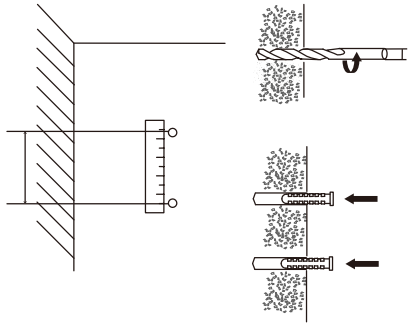

6

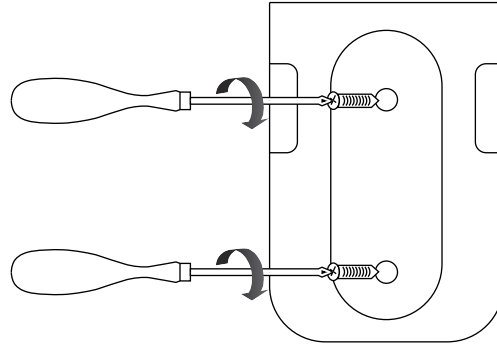

7

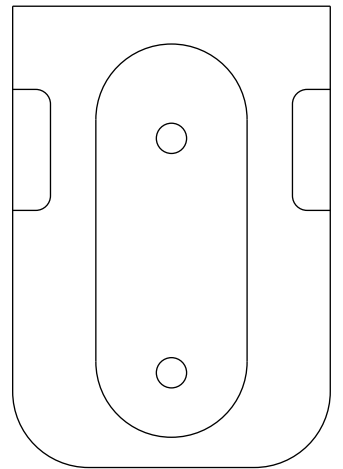
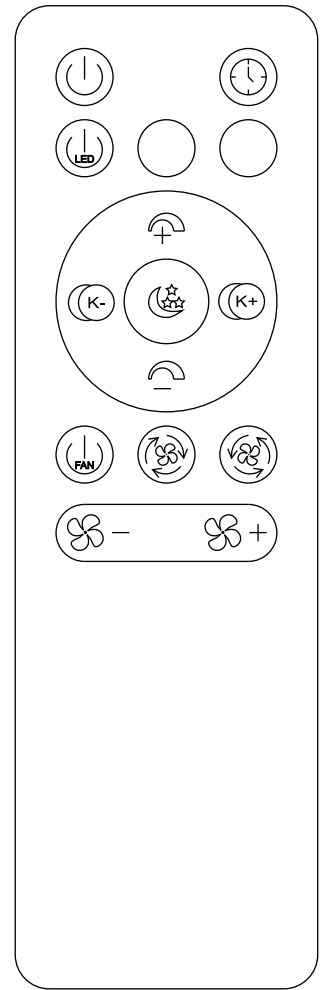

11

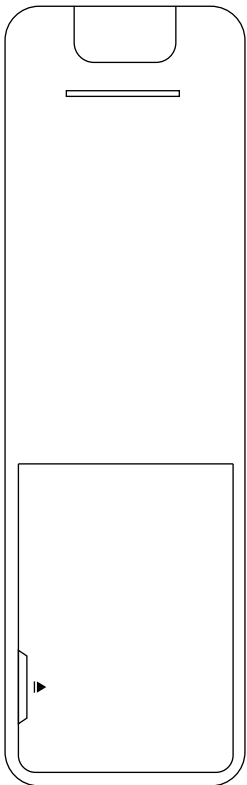

8

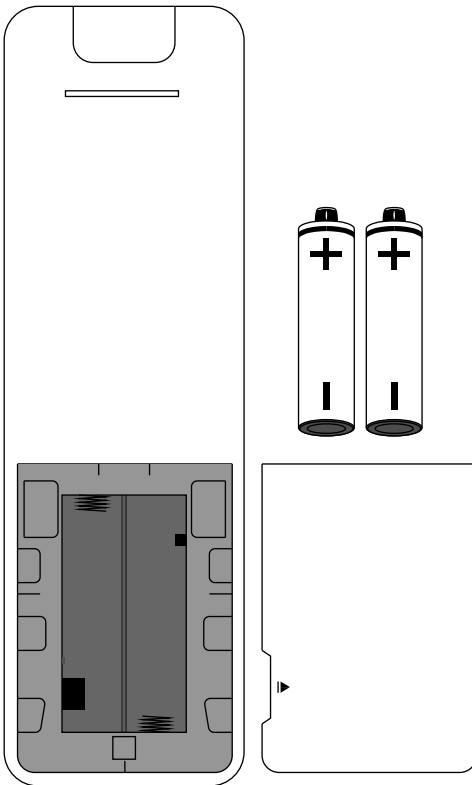

9

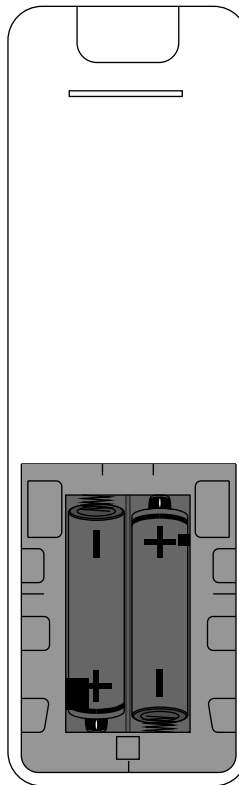

10

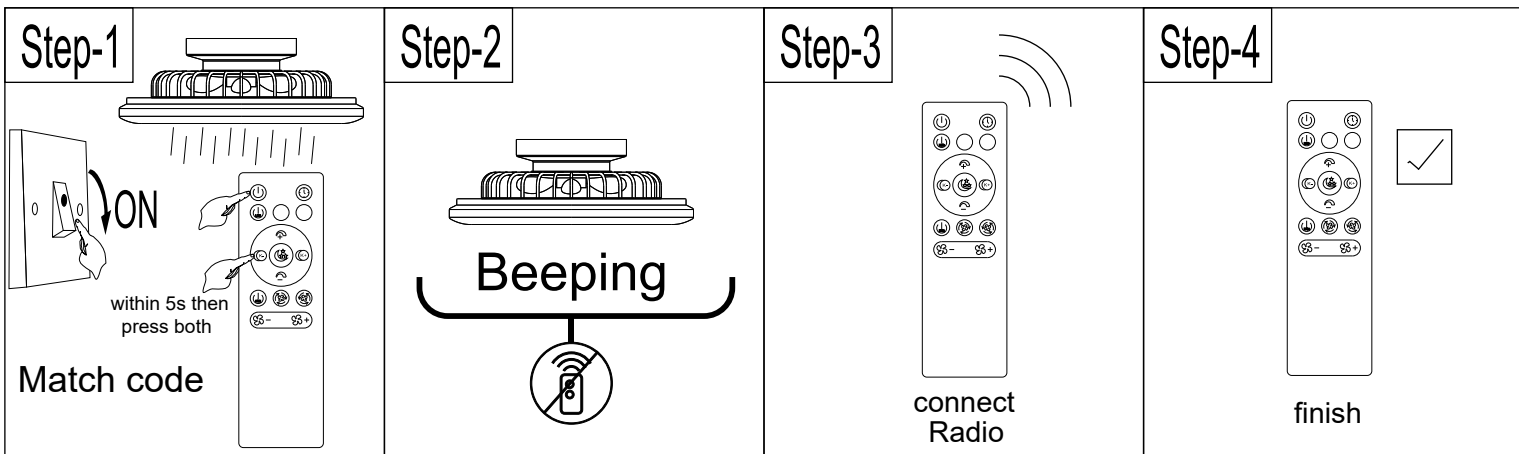
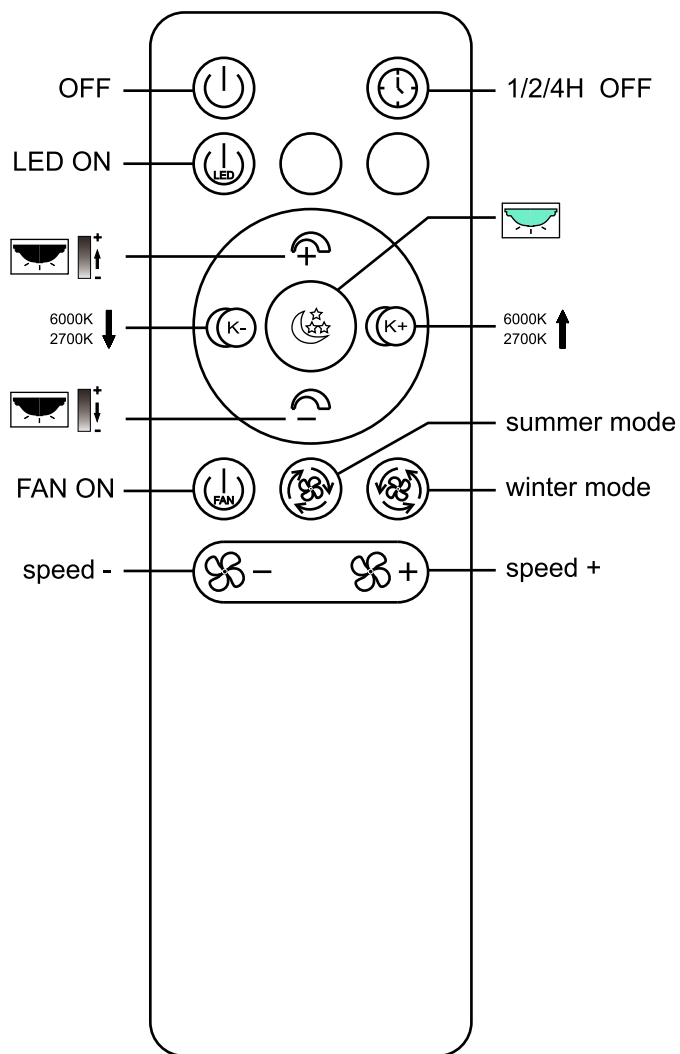

Lichtquelle/Light Source:

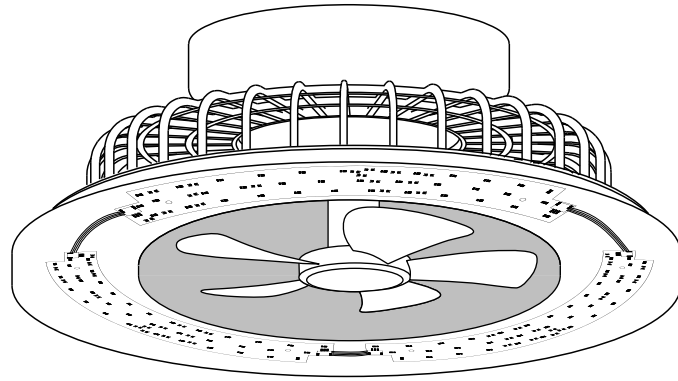

DEU:

Lichtquelle:

Die Lichtquelle ist nicht tauschbar, weil sie konstruktionsbedingt fest mit dem umgebenden Produkt verbunden ist.

Dieses Produkt enthält eine Lichtquelle der Energieeffizienzklasse <E>.



Austausch des Betriebsgeräts durch einen Professionisten.



Leuchtmittel nicht austauschbar.

GBR:

Light source:

The light source is not interchangeable because it is determined by the surrounding product design.

This product contains a light source of energy efficiency class <E>.



Replaceable control gear by a professional.



Non replaceable light source.

BIH& HR:

Izvor svjetla :

Izvor svjetla nije zamjenjiv , jer je konstrukcijski pričvršćen na proizvod .

Ovaj proizvod sadrži izvor svjetlosti klase energetske učinkovitosti <E>.



Izmjenu pogonskog uređaja smije izvršiti i samo profesionalna osoba



LED žarulje nije moguće zamjeniti

BG:

Източник на светлина:

Източникът на светлина не може да се подменя, тъй като поради конструкцията си е трайно фиксиран към заобикалящия го продукт.

Този продукт включва светлинен източник с клас на енергийна ефективност <E>.

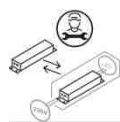

Смяна на управляващото устройство от професионалист.



Източникът на светлина не може да се подменя.

CZ:

Zdroj světla:

Světelný zdroj není možné vyměnit, protože je díky své konstrukci pevně spojený s produktem.

Tento výrobek obsahuje světelný zdroj s třídou energetické účinnosti <E>.



Výměna předřadníku jen odborníkem.



Světelný zdroj není vyměnitelný.

DK:

Lyskilde:

Lyskilden kan ikke udskiftes, fordi den er fast forbundet med det omgivende produkt.

Dette produkt indeholder en lyskilde i energieffektivitetsklasse < E>.



Enheden skal skiftes af en fagperson.



Lyskilden kan ikke udskiftes.

ES:

Fuente de luz:

La fuente de luz no es sustituible porque está fija en el producto desde la construcción.

Este producto contiene una fuente luminosa de la clase de eficiencia energética <E>.



Sustitución del aparato por un profesional.



Bombilla no reemplazable.

ET:

Valgusallikas:

Valgusallikas ei ole välja vahetatav, sest ta on tootega ehituslikult kindlalt seotud.

Toode sisaldab energiatõhususe klassi <E> valgusallikat.



Juhtimisseadise välja vahetamine professionaali poolt.



Lamp ei ole välja vahetatav.

FI:

Valonlähde:

Valonlähdettä ei voi vaihtaa uuteen, sillä se on rakenteellisesti yhdistetty ympäröivään tuotteeseen.

Tämä tuote sisältää valonlähteen, jonka energiatehokkuusluokka on <E>.



Liitäntälaitteen vaihtaa ammattilainen.



Valonlähdettä ei voi vaihtaa.

FR:

Source lumineuse:

La source lumineuse n'est pas remplaçable car elle est, de par la construction du produit, liée de façon permanente à celui-ci.

Ce produit contient une source lumineuse de classe d'efficacité énergétique <E>.



Remplacement du dispositif de commande par un professionnel.



Ampoule non remplaçable.

GR:

Φωτεινή πηγή:

Η φωτεινή πηγή δεν μπορεί να αντικατασταθεί, επειδή είναι για κατασκευαστικούς λόγους σταθερά συνδεδεμένη με το προϊόν που την περιβάλλει.

Το προϊόν αυτό περιέχει φωτεινή πηγή της τάξης ενεργειακής απόδοσης <E>.



Αντικατάσταση της διάταξης λειτουργίας από έναν επαγγελματία



Ο λαμπτήρας δεν μπορεί να αντικατασταθεί.

HU:

Fényforrás:

A fényforrás nem cserélhető, mert felépítése miatt szilárdan csatlakozik a termékhez

Ez a termék egy <E> energiahatékonysági osztályú fényforrást tartalmaz.



Az előtétet csak szakértők cserélhetik ki.



A fényforrás nem cserélhető

Isländisch/IS:

Ljósgrjafi:

Ljósgrjafi er ekki útskiptanlegur vegna þess að hann er háður umliggjandi hönnun vörunnar.

Varan inniheldur ljósgrjafa í orkuflokki <E>.



Útskiptanlegur stýribúnaður sem fagmaður á að framkvæma.



Ekki útskiptanlegur ljósgrjafi.

IT:

Sorgente luminosa:

La sorgente luminosa non è intercambiabile perché è saldamente collegata al prodotto per via del suo design.

Questo prodotto contiene una sorgente luminosa di classe di efficienza energetica <E>.



Sostituzione dell'alimentatore da parte di un professionista.



Lampadine non intercambiabili.

LT:

Šviesos šaltinis:

Šis šviesos šaltinis yra nekeičiamas, nes jis prijungtas prie gaminio pagal jo konstrukciją.

Šiame gaminyje yra šviesos šaltinis, kurio energijos vartojimo efektyvumo klasė <E>.



Valdymo įtaisą keičia profesionalas.



Šviesos šaltinis yra nekeičiamas.

LV:

Gaismas avots:

Gaismas avotu nevar nomainīt, jo tas konstrukcijā ir cieši savienots ar izstrādājuma apkārtējo daļu.

Šis ražojums satur gaismas avotu, kura energoefektivitātes klase ir <E>.



Vadības ierīci var nomainīt speciālists.



Apgaismes līdzekli nevar nomainīt.

NL:

Lichtbron:

De lichtbron kan niet worden vervangen, omdat deze vanwege de constructie vast met het product eromheen verbonden is.

Dit product bevat een lichtbron van energie-efficiëntieklasse <E>.



Vervanging van het apparaat door een expert.



Verlichting kan niet worden vervangen.

Norwegisch/Norwegian / NO:

Lyskilde:

Lyskilden kan ikke byttes fordi den sitter fast i produktet.

Dette produktet inneholder en lyskilde i energiklasse <E>.



Bytte av driftsapparatet må gjøres av fagmann.



Lyskilden kan ikke byttes ut.

PL:

Źródło światła:

Źródła światła nie można wymienić, ponieważ jest zintegrowane z produktem ze względu na swoją konstrukcję.

Ten produkt zawiera źródło światła o klasie efektywności energetycznej <E>.



Wymiana osprzętu sterującego wyłącznie przez specjalistę.



Źródła światła nie można wymienić.

PT:

Fonte de Luz:

A fonte de luz não é substituível porque devido às suas características construtivas está fixada de forma permanente ao produto circundante.

Este produto contém uma fonte de luz da classe de eficiência energética <E>.



Substituição do dispositivo de comando por parte de um profissional.



Lâmpada não substituível.

RO:

Sursa de lumina:

Sursa de lumina nu este inlocuibilă ea fiind parte constructivă a produsului

Acest produs conține o sursă de lumină cu clasa de eficiență energetică <E>.



Substituição do dispositivo de comando por parte de um profissional.



Lâmpada não substituível.

RUS:

Источник света:

Источник света не является взаимозаменяемым, поскольку это определяется конструкцией смежного продукта.

Данный продукт содержит источник света класса энергоэффективности <E>.



Замена регулировочного механизма специалистом.



Незаменяемый источник света.

SK:

Zdroj svetla:

Svetelný zdroj nie je možné vymeniť, pretože je vďaka svojej konštrukcii pevne spojený s produktom.

Tento výrobok obsahuje svetelný zdroj triedy energetickej účinnosti <E>.



Výmena predradníka len odborníkom.



Svetelný zdroj nie je vymeniteľný.

SI:

Izvor svetlobe:

Vir svetlobe ni zamenljiv, ker je določen z zasnovo izdelka v okolici.

Ta izdelek vsebuje svetlobni vir razreda energijske učinkovitosti <E>.



Zamenljiv krmilnik s strani strokovne osebe.



Nezamenljiv vir svetlobe.

SRB:

Izvor svetlosti:

Izvor svetlosti nije zamenljiv, jer je zbog svog dizajna čvrsto povezan sa proizvodom koji ga opkružuje.

Ovaj proizvod sadrži izvor svetlosti klase energetske efikasnosti <E>.



Zamena upravljačkog uređaja od strane profesionalca.



Izvor svetlosti se ne može zameniti.

SE:

Ljuskälla:

Ljuskällan är inte utbytbar, eftersom den på grund av konstruktionen är fast integrerad i den omgivande produkten.

Denna produkt innehåller en ljuskälla med energieffektivitetsklass <E>.



Byte av driftdonet genom en fackman.



Ljuskällan är inte utbytbar.

TR:

Işık kaynağı:

Konstrüksiyon gereği çevreleyen ürün ile sabit bir şekilde bağlı olduğu için ışık kaynağı değiştirilemez.

Bu ürün, <E> enerji sınıfından bir ışık kaynağına sahiptir.



İşletme cihazının bir profesyonel tarafından değiştirilmesi.



Aydınlatma malzemesi değiştirilemez.

UK:

Джерело світла:

Джерело світла не можна обміняти, оскільки воно міцно пов'язане з навколишнім виробом завдяки своїй конструкції.

Цей виріб містить джерело світла класу енергоефективності <E>.



Заміна контрольної передачі професіоналом.



Цибулини не взаємозамінні.