

AE BO10 KF HVI LI V2A (819 299)

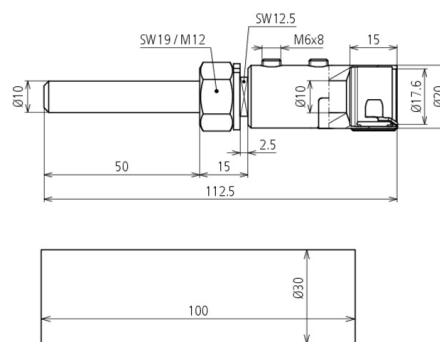

Figure without obligation

Type	AE BO10 KF HVI LI V2A
Part No.	819 299
Material	StSt
Connection	bolt Ø10 mm, L 50 mm
Diameter Ø connection element	20 mm
Design	with spring washer
Screw	threaded bolt M6 x 8 mm
Material of screw / nut	StSt
Lightning current carrying capability (10/350 µs)	150 kA
Weight	135 g
Customs tariff number (Comb. Nomenclature EU)	85389099
GTIN	4013364118911
PU	1 pc(s)

We reserve the right to introduce changes in performance, configuration and technology, dimensions, weights and materials in the course of technical progress. The figures are shown without obligation.