

DLH SG 8 H32 FG180.280 V2A (206 249)

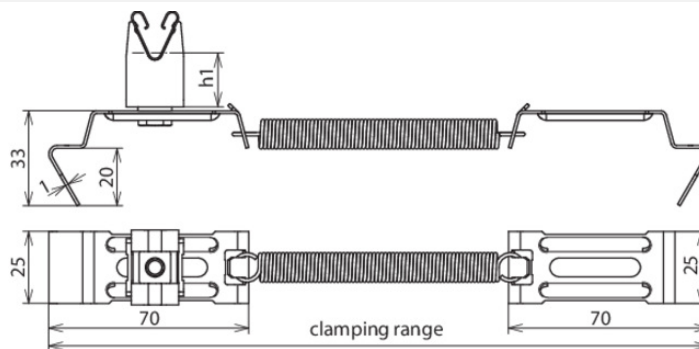

Figure without obligation



Type	DLH SG 8 H32 FG180.280 V2A
Part No.	206 249
Type of roof conductor holder	SPANNgrip
Material of roof conductor holder	StSt
Clamping range of ridge tile width	180-280 mm
Height of conductor holder (h1)	32 mm
Material of conductor holder	StSt
Conductor support Rd	8 mm
Length of supporting claw	20 mm
Type of conductor holder	DEHNgrip
Conductor routing	loose
Application note	laterally adjustable conductor leading
Standard	EN 62561-4
Weight	80 g
Customs tariff number (Comb. Nomenclature EU)	85389099
GTIN	4013364042803
PU	25 pc(s)

We reserve the right to introduce changes in performance, configuration and technology, dimensions, weights and materials in the course of technical progress. The figures are shown without obligation.