

PKS 50 10 CUGALSN (472 435)

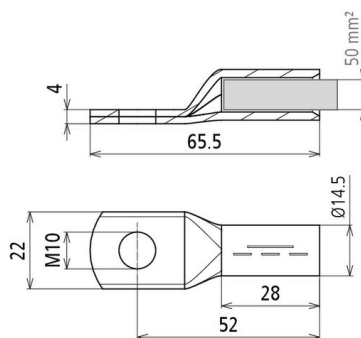

Figure without obligation



Crimped cable lug according to DIN 46235 with nickel barrier layer to avoid whisker formation.

Type	PKS 50 10 CUGALSN
Part No.	472 435 NEW
Material	Cu/gal (Ni)Sn
Lightning impulse current (10/350 µs) Cugal (Ni)Sn 50 mm ² (Rm/Rf) / stainless steel 40x10 mm	1HEXIIIC 100 kA (non-sparking) T4
Max. short-circuit current (AC 50 Hz / DC / 5 s) Cugal (Ni)Sn 50 mm ² (Rm/Rf) / StSt 40x10 mm	2600 A / T4
Max. surface temperature T4	135 °C
Cable lug hole	M10
Conductor cross-section	50 mm ²
Weight	49 g
Customs tariff number (Comb. Nomenclature EU)	85389099
GTIN	4013364470569
PU	3 pc(s)

Note: Non-sparking only ensured in connection with PAS EX ...!

We reserve the right to introduce changes in performance, configuration and technology, dimensions, weights and materials in the course of technical progress. The figures are shown without obligation.