

KKH 25 HG (772 323)

- Earthing and short-circuiting devices can be configured online via the earthing and short-circuiting configurator



Figure without obligation

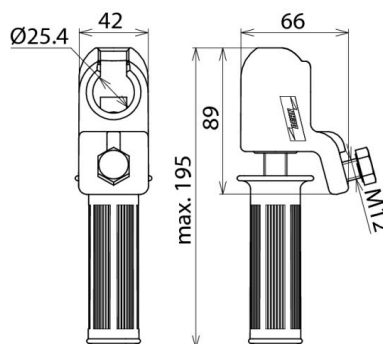

Figure without obligation

Type	KKH 25 HG
Part No.	772 323
For fixed ball point Ø	25 mm
Anti-rotation cable lug	PK1
For cable cross-section Cu	16 ... 150 mm ²
Max. short-circuit current I _k 0.5 s	42.0 kA
Max. short-circuit current I _k 1 s	29.6 kA
Standard	EN/IEC 61230 (DIN VDE 0683-100)
Temperature range	-25 °C ... +55 °C
Material (clamp body)	Cu alloy/gal Sn
Material (shaft)	Cu alloy/gal Sn
Material (pressure plate)	Cu alloy/gal Sn
Weight	876 g
Customs tariff number (Comb. Nomenclature EU)	85389099
GTIN	4013364054462
PU	1 pc(s)

We reserve the right to introduce changes in performance, configuration and technology, dimensions, weights and materials in the course of technical progress. The figures are shown without obligation.

The clamps must have the same maximum short-circuit current as the earthing and short-circuiting cables!