



DC BK 6 RD10 STBLANK (308 130)

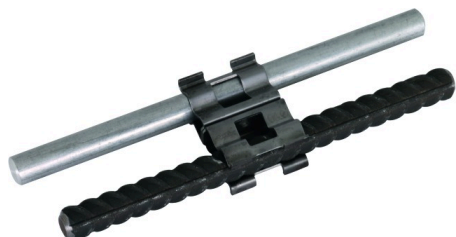
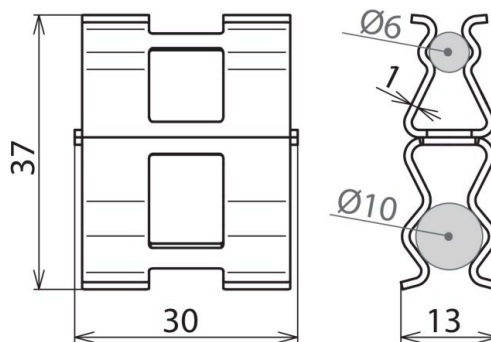

Figure without obligation



- Compact, light and resource-saving
- Quick and without tools
- Efficient and time-saving



Type	DC BK 6 RD10 STBLANK
Part No.	308 130
Material	St/bare
Clamping range Rd* / Rd	6-7 / 10 mm
Material thickness (t1)	1 mm
Short-circuit current (a.c. 50 Hz / d.c.) (1 s; ≤ 300 °C)	2.5 kA
Lightning current carrying capability (10/350 µs)	50 kA**
Standard	EN 62561-1
Weight	18 g
Customs tariff number (Comb. Nomenclature EU)	85389099
GTIN	4013364288942
PU	50 pc(s)

*) Nominal diameter d_s of the reinforcement

**) For exact assignment see test certificate.

We reserve the right to introduce changes in performance, configuration and technology, dimensions, weights and materials in the course of technical progress. The figures are shown without obligation.