

Build-in switch SV

Technical data	
Type	16A-40A
Electrical	
Number of poles	1p, 2p, 3p, 4p
Rated operational voltage Ue	230/400V AC (1p), 400V AC (2p, 3p 4p)
Rated current In	16, 25, 40A
Rated insulation voltage Ui	1000V
Rated impulse withstand voltage Uimp	4 kV
Utilization category	AC-23B
Rated frequency	50/60Hz
Rated short-time withstand current Icw	800A
Rated short-circuit making capacity Icm	500A
Rated conditional short-circuit current	2000A (with 50A fuse)
Rated making capacity	400A
Rated breaking capacity	320A
Switch Type	Build-in switch
Standard	IEC/EN 60947-3
Mechanical	
Device height	68mm (DIN rail acc to EN60715)
Device width	18mm/p
Degree of protection	IP20
Terminal capacity	1-25mm ²
Terminal screw	M5 (Pozidrive PZ2)
Terminal torque	max 3Nm
Operating temperature	-25°C ... +55°C
Storage- and transport temperature	-40°C ... +70°C
Contact position indicator	mechanical red/green
Supply possibility	Top or bottom

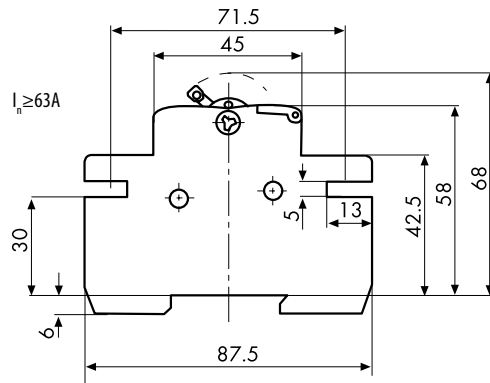

Technical data	
Type	63-125A
Electrical	
Number of poles	1p, 2p, 3p, 4p
Rated operational voltage Ue	1p: 230/400V AC, 24V DC 2p: 400V AC, 48V DC 3p, 4p: 400V AC
Rated current In	63, 80, 100, 125A
Rated Insulation voltage Ui	AC: 1000V; DC:1500V
Rated impulse withstand voltage Uimp	4 kV
Utilization category	AC-22B; DC-22B
Rated frequency	50/60Hz AC, DC
Rated short-time withstand current Icw	1500A / 1s
Rated short-circuit making capacity Icm	2200A peak
Rated conditional short-circuit current	4,0kA (with 100A fuse) / 2,5kA (with 125A fuse)
Rated making capacity	400A
Rated breaking capacity	320A
Switch Type	Build-in switch-disconnector
Standard	IEC/EN 60947-3
Mechanical	
Device height	68mm (DIN rail acc to EN60715)
Device width	18mm/pole
Degree of protection	IP20
Terminal capacity	1-50mm ²
Terminal screw	M6 (Pozidrive PZ2)
Terminal torque	max 3Nm
Operating temperature	-25°C ... +55°C
Storage- and transport temperature	-40°C ... +70°C
Contact position indicator	mechanical red/green
Supply possibility	Top or bottom

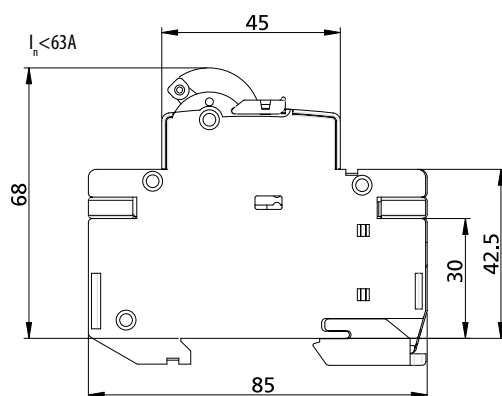

Technical data

Build-in devices "EVESYS"

Technical data	
Rated voltage U_n	230/400V AC, 24V DC
Rated current I_n	16A, 25A
Rated frequency f_n	50/60 Hz
Terminals	1x6mm ² / 2x2,5mm ² , max 1Nm
Electrical insulation	>3mm contact space
Rated making and breaking capacity	1,25I _n / 1,1 U _n , cosφ=0,6
Rated conditional short-circuit current	10kA, 400V, cosφ=0,6 (for Switch)
Degree of protection	IP20
Width of the switch	18mm
Standards	IEC/EN 60947-1, IEC/EN 60947-3

Switch

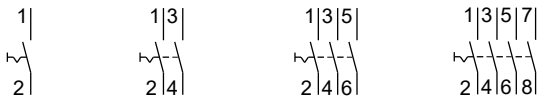

SG 116 **SG 216** **SG 316** **SG 416**

Switch with control light

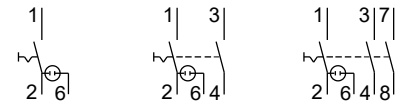

SLG 116 **SLG 216** **SLG 316**

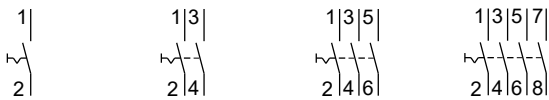

SG 125 **SG 225** **SG 325** **SG 425**

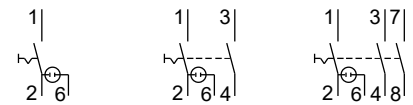

SLG 125 **SLG 225** **SLG 325**

Change-over switch

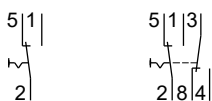

ISG 116 **ISG 216**

Center-off Change-over Switch



SSG 116 **SSG 216**

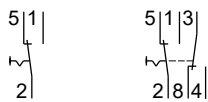

ISG 125 **ISG 225**



SSG 125 **SSG 225**

Push-button



TG 216

Signal light

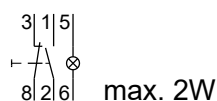

TLG 216

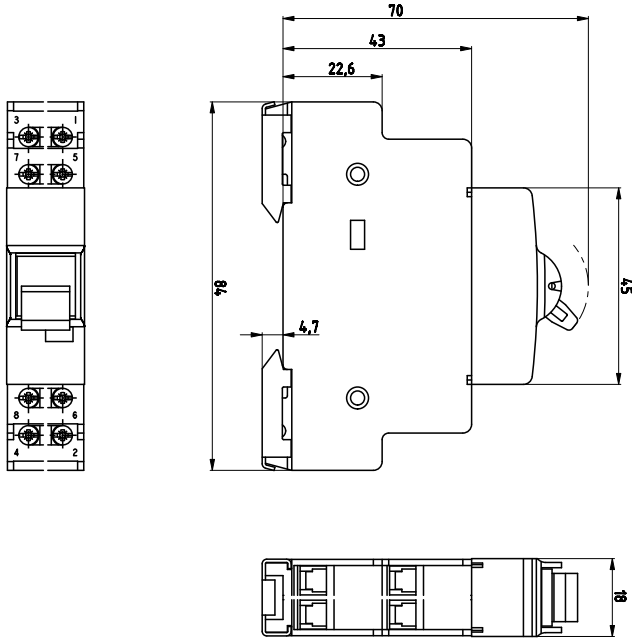

Switch, Switch with control light, Change-over switch, Push-button, Push-button with control light, Signal light

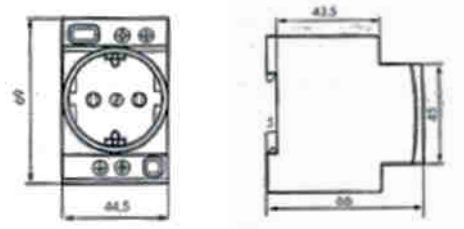

DIN socket

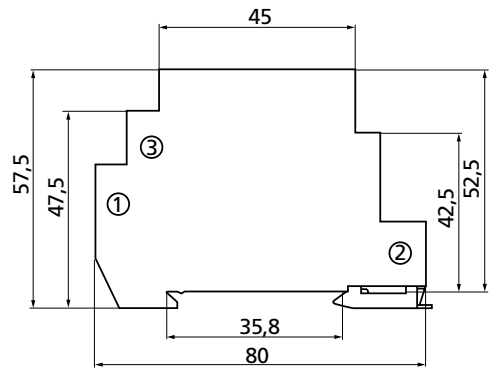

Bell/Buzzer

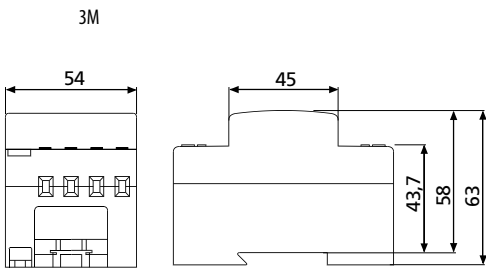

Bell transformer type 3M

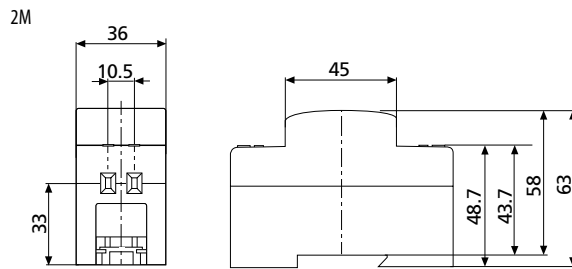

Bell transformer type 2M

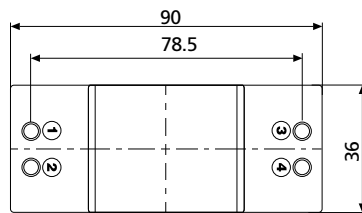
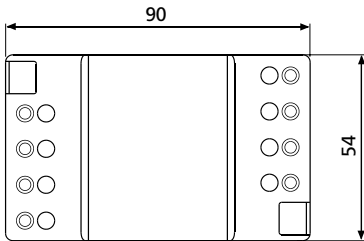

Technical data				
	SON H-1R	SON H-1G	SON H-3R	SON H-3K
Rated voltage U_n	240V AC		3x240V AC	
Voltage tolerance	-25%...+10%			
Rated frequency f_n	50/60Hz			
Power consumption	0,267W (240V AC)		1,04W (240V AC)	
Diode colour	1 red	1 green	3 red	1 red, 1 yellow, 1 green
Protection class	Casing: IP40, terminals IP20			
Humidity	95% (without condensation)			
Material	Self-extinguished material UL94-V0			
Cross section	1-4 mm ²			
Torque	0,6 Nm			
Montage	TH35			
Width	1 Modul			
Standards	IEC EN 61000-3-2; IEC EN 61000-4			

Technical data

Power relays VS116K, VS316K

Technical data

	VS116K	VS316/24	VS316/230
Supply terminals	A1 - A2		
Voltage range	230 V AC/50-60 Hz	24 V AC/DC/50-60 Hz	230 V AC/50-60 Hz
Burden	AC max. 7.5 VA/ 1W	1.6 VA/ 1.2 W	2.5 VA
Supply terminals	A1-A3	x	
Voltage range	24 V AC/DC (50-60 Hz)	x	
Burden	1 VA AC/ 1W DC	x	
Supply voltage tolerance	-15%; +10%		
Output			
Number of contacts	1 x changeover/ SPDT (AgSnO ₂)	3 x changeover/ 3PDT (AgSnO ₂)	
Current rating	16 A/ AC1	16A/ AC1	
Breaking capacity	4000VA/ AC1, 384W/ DC	4000VA/ AC1, 384W/ DC	
Inrush current	30 A/ <3s	30 A/ <3s	
Switching voltage	250 V AC1/ 24 V DC		
Min. breaking capacity DC	500 mW		
Output indication	high intensity of LED		
Mechanical life	3x10 ⁷	1x10 ⁷	
Electrical life (AC1)	0.7x10 ⁵	1x10 ⁵	
Time between switching	min. 2s	20 ms	50 ms
Other information			
Operating temperature	-20 °C ... +55 °C (-4 °F ... 131 °F)		
Storage temperature	-30 °C ... +70 °C (-22 °F ... 158 °F)		
Electrical strength	4 kV (supply-output)		
Operating position	any		
Mounting/DIN rail	DIN rail EN 60715		
Protection degree	IP 40 from front panel		
Overvoltage category	III.		
Pollution degree	2		
Max. cable size (mm ²)	max. 1x 2.5 / 2x1.5 max. 1x2.5		
Dimensions	90 x 17.6 x 64 mm (3.5" x 0.7" x 2.5")		
Weight	54 g (1.9 oz.)	90 g (3.17 oz.)	92 g (3.25 oz.)
Standards	EN 61810-1, EN 61010-1		

Symbol

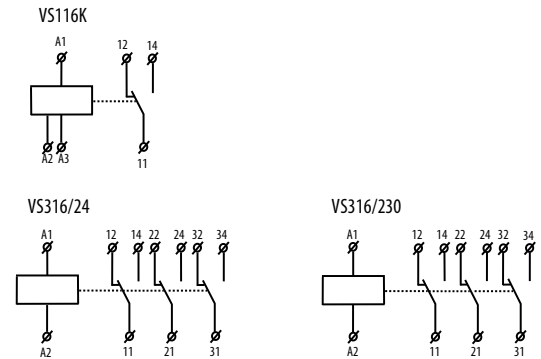

Description

VS116K

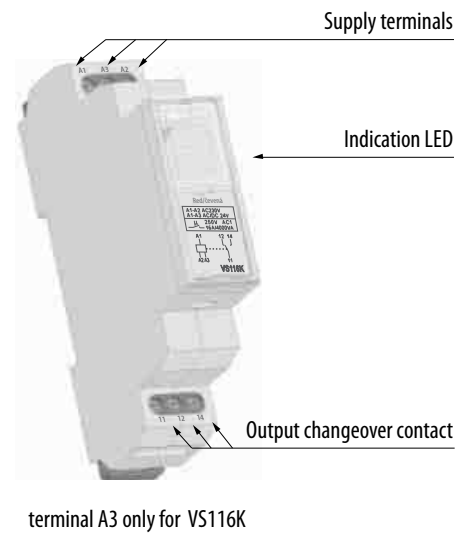

VS316/24, VS316/230

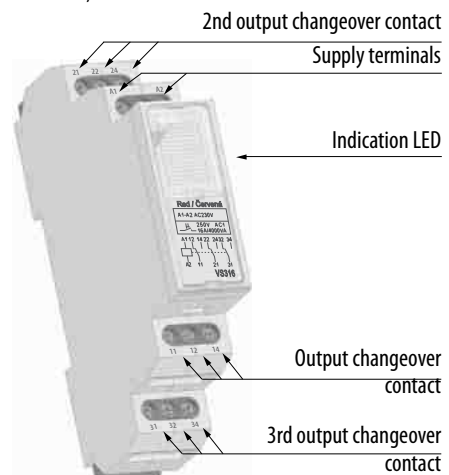

Notes

Max. time of changeover of contact is 10ms.
VS316/24 and VS316/230 enable switching of different phases or 3 phase voltage.

Multifunction time relay ETR-91 and ETR-93

Technical data		
	ETR-91	ETR-93
Output circuit		
Number and type of contacts	1 CO	3 CO
Contact material	AgSnO ₂	
Max. switching voltage	300 V AC	
Rated load	AC1: 16 A / 250 V AC DC1: 16 A / 24 V DC; 0,3 A / 250 V DC	AC1: 8 A / 250 V AC DC1: 8 A / 24 V DC; 0,2 A / 250 V DC
Rated current	16 A / 250 V AC	8 A / 250 V AC
Max. breaking capacity	AC1: 4000 VA	AC1: 2000 VA
Min. breaking capacity	1 W 10 mA	
Input circuit		
Rated voltage	12...240 V AC/DC AC: 50/60 Hz, (+)A1, (-)A2	
Rated power consumption	≤ 1,5 VA AC AC: 50 Hz ≤ 1,5 W DC	
Insulation (EN 60664-1)		
Insulation rated voltage	250 V AC	
Rated surge voltage	4000 V 1,2 / 50 μs	
Overvoltage category	III	
Insulation pollution degree	2	
Dielectric strength		
• input - output	4000 V AC *	4000 V AC *
• contact clearance	1000 V AC **	1000 V AC **
• pole - pole		2000 V AC **
General data		
Electrical life	AC1: > 0,5 x 10 ⁹	
Mechanical life	> 3 x 10 ⁷	
Dimensions (L x W x H)	90*** x 17,5 x 64,5 mm	
Weight	65 g	88g
Ambient temperature	• storage • operating	-40...+70 °C -20...+50 °C
Cover protection category	IP 20	
Time module data		
Functions	E, Wu, Bp, Bi, R, Ws, Wa, Esa, B, T	
Time ranges	OFF, ON****; 1 s*****; 10 s; 1 min.; 10 min.; 1 h; 10 h; 1 d; 10 d	
Timing adjustment (smooth)	(0,1...1) x time range*****	
Setting accuracy	± 5% ***** , *****	
Repeatability	± 0,5% *****	

* Type of insulation: basic.

** Type of clearance: micro-disconnection.

*** Length with 35 mm rail catches: 98,8 mm.

****OFF - permanent switching off, ON - permanent switching on.

***** For first range setpoint (1 s) setting accuracy and repeatability are smaller than the given ones in technical parameters (significant influence of the operational relay operating time, processor start-time, and the moment of supply switching as referred to the AC supply course).

***** Timing adjustment (smooth): (0,1...1) x time range – does not refer to range ON / OFF.

*****Calculated from the final range values, for the setting direction from minimum to maximum.

Technical data

Connection

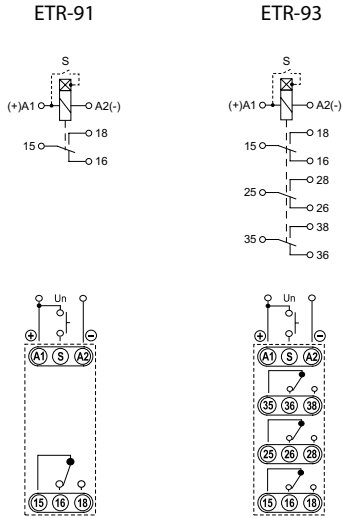

Description

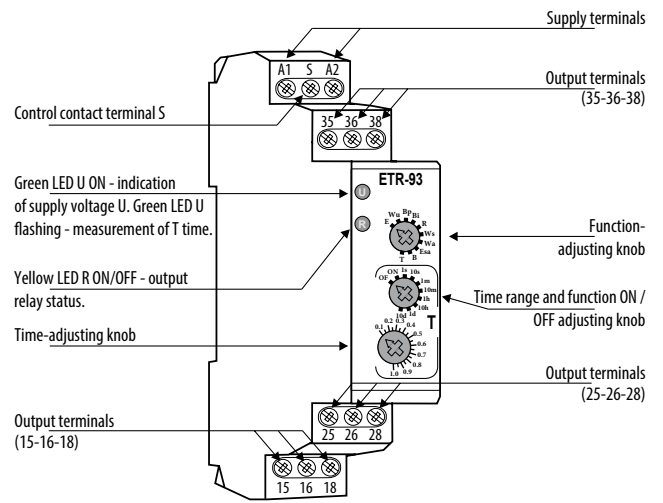

Function

The function changes immediately after it has been selected (without switching power supply off and on again).

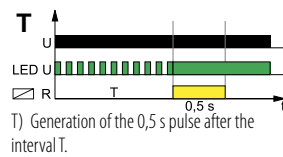
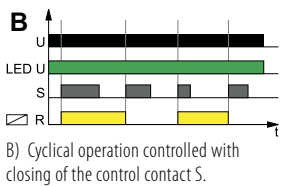
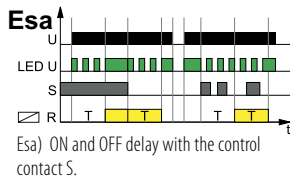
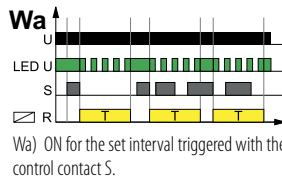
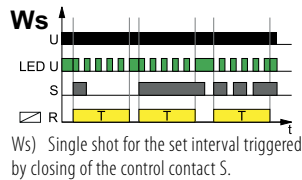
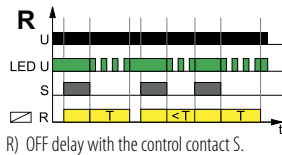
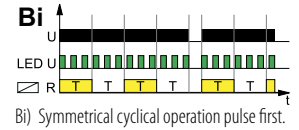
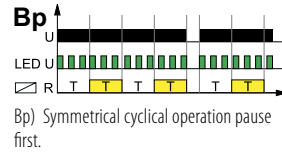
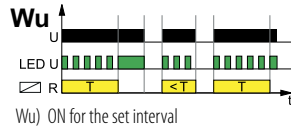
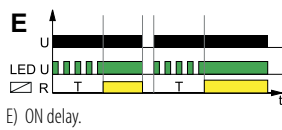

ON / OFF - Permanent switching on / off.

U - supply voltage; R - output state of the relay; S - control contact state; T - measured time; t - time axis

Multifunction time delay relay ETR-82TO

Technical data

ETR-82TO	
Output circuit	
Number and type of contacts	2 CO
Contact material	AgSnO ₂
Max. switching voltage	300 V AC
Rated load	AC1: 8 A / 250 V AC DC1: 8 A / 24 V DC; 0,2 A / 250 V DC
Rated current	8 A / 250 V AC
Max. breaking capacity	AC1: 2000 VA
Min. breaking capacity	1 W 10 mA
Input circuit	
Rated voltage	12...240 V AC/DC AC: 50/60 Hz, (+)A1, (-)A2
Rated power consumption	≤ 1,5 VA AC AC: 50 Hz ≤ 1,5 W DC
Insulation (EN 60664-1)	
Insulation rated voltage	250 V AC
Rated surge voltage	4000 V 1,2 / 50 μs
Overtension category	III
Insulation pollution degree	2
Dielectric strength	
• input - output	4000 V AC *
• contact clearance	1000 V AC **
• pole - pole	2000 V AC **
General data	
Electrical life	AC1: > 0,5 x 10 ⁵
Mechanical life	> 3 x 10 ⁷
Dimensions (L x W x H)	90*** x 17,5 x 64,5 mm
Weight	72 g
Ambient temperature	• storage -40...+70 °C • operating -20...+50 °C
Cover protection category	IP 20
Time module data	
Functions	E, A, nWu, nWu, nWuWa, nWs
Time ranges	1 s****; 10 s; 20 s; 30 s; 1 min.; 1,5 min.; 2 min.; 3 min.; 5 min.; 10 min.
Timing adjustment (smooth)	(0,1...1) x time range*****
Setting accuracy	± 5% *****, ****
Repeatability	± 0,5% *****

* Type of insulation: basic.

** Type of clearance: micro-disconnection.

*** Length with 35 mm rail catches: 98,8 mm.

**** For first range setpoint (1 s) setting accuracy and repeatability are smaller than the given ones in technical parameters (significant influence of the operational relay operating time, processor start-time, and the moment of supply switching as referred to the AC supply course).

***** Timing adjustment (smooth): (0,1...1) x time range.

***** Calculated from the final range values, for the setting direction from minimum to maximum.

Connection

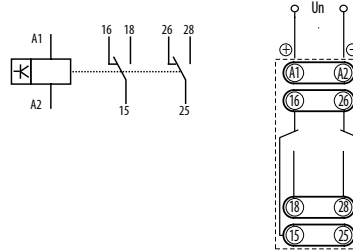

Description

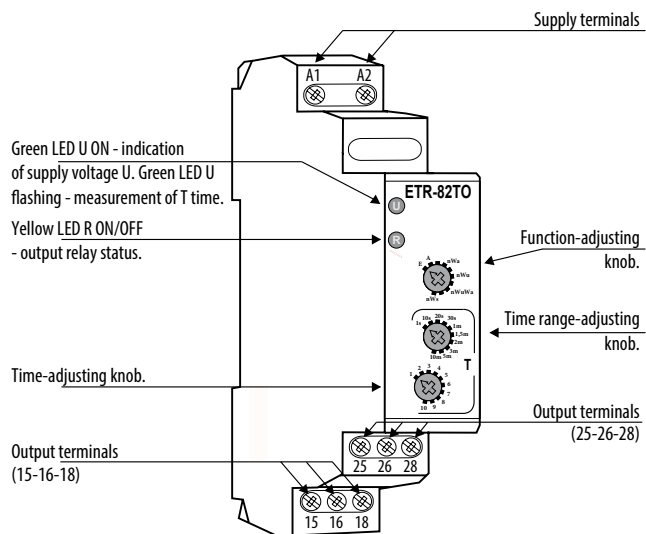

Function

The function changes immediately after it has been selected (without switching power supply off and on again).

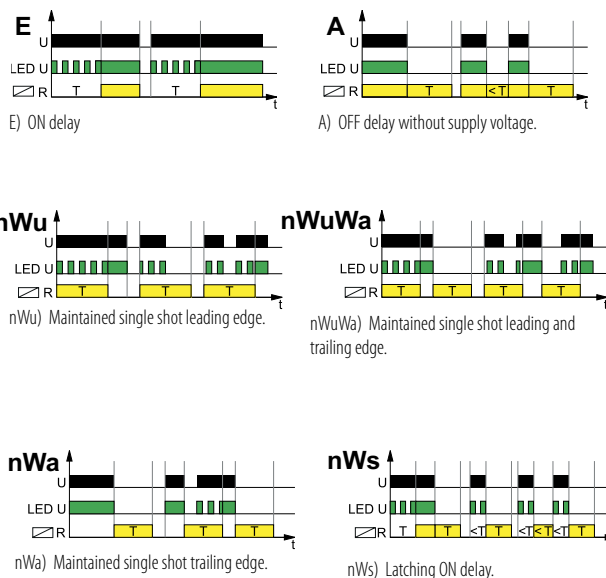

U - supply voltage; R - output state of the relay;
S - control contact state; T - measured time; t - time axis

Technical data

Single-function asymmetric cyler time relay ETR-2H

Technical data	
	ETR-2H
Output circuit	
Number and type of contacts	1 CO
Contact material	AgSnO ₂
Max. switching voltage	300 V AC
Rated load	AC1: 16 A / 250 V AC DC1: 16 A / 24 V DC; 0,3 A / 250 V DC
Rated current	16 A / 250 V AC
Max. breaking capacity	AC1: 4000 VA
Min. breaking capacity	1 W 10 mA
Input circuit	
Rated voltage	12...240 V AC/DC AC: 50/60 Hz, (+)A1, (-)A2
Rated power consumption	≤ 1,5 VA AC AC: 50 Hz ≤ 1,5 W DC
Insulation (EN 60664-1)	
Insulation rated voltage	250 V AC
Rated surge voltage	4000 V 1,2 / 50 μs
Overtoltage category	III
Insulation pollution degree	2
Dielectric strength	
• input - output	4000 V AC *
• contact clearance	1000 V AC **
General data	
Electrical life	AC1: > 0,5 x 10 ⁵
Mechanical life	> 3 x 10 ⁷
Dimensions (L x W x H)	90*** x 17,5 x 64,5 mm
Weight	65...66 g
Ambient temperature	• storage -40...+70 °C • operating -20...+50 °C
Cover protection category	IP 20
Time module data	
Functions	li + lp
Time ranges	OFF, ON****; 1 s*****; 10 s; 1 min.; 10 min.; 1 h; 10 h; 1 d; 10 d
Timing adjustment (smooth)	(0,1...1) x time range*****
Setting accuracy	± 5% ***** , *****
Repeatability	± 0,5% *****

* Type of insulation: basic.
 ** Type of clearance: micro-disconnection.
 *** Length with 35 mm rail catches: 98,8 mm.
 **** OFF - permanent switching off, ON - permanent switching on.
 ***** For first range setpoint (1 s) setting accuracy and repeatability are smaller than the given ones in technical parameters (significant influence of the operational relay operating time, processor start-time, and the moment of supply switching as referred to the AC supply course).
 ***** Timing adjustment (smooth): (0,1...1) x time range – does not refer to range ON / OFF.
 ***** Calculated from the final range values, for the setting direction from minimum to maximum.

Connection

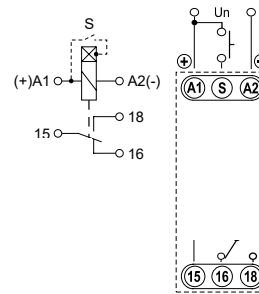

Description

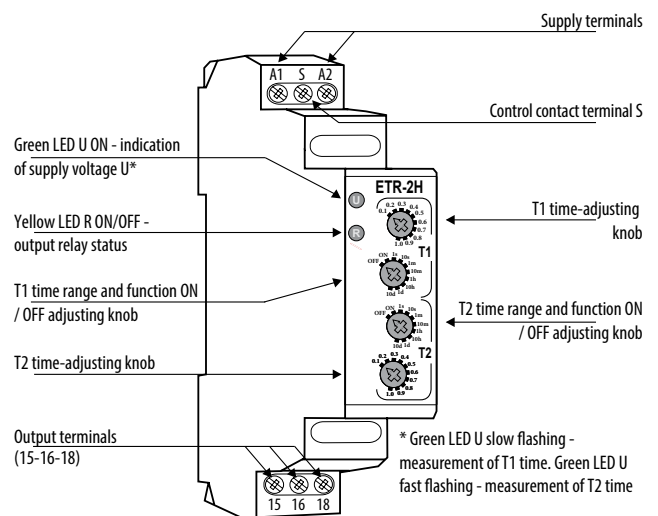

Function

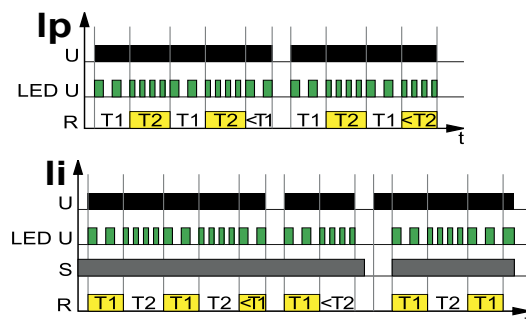

li + lp) Cyclical operation in two independent intervals T1 and T2. Operation in the function li or lp depending on the position of the control contact S. Application of the supply voltage U when the control contact S is open start the cyclical operation in the lp function - from the interval T1 (time of switching off the output relay R), following which the output relay R is switched on for the interval T2. The cyclical operation continues until the supply voltage U is interrupted. When the control contact S is closed, application of the supply voltage U starts operation in the li function - from switching on the output relay R for the interval T1, and after the interval T1 has lapsed, the output relay switches off for the interval T2. The cyclical operation continues until the supply voltage U is interrupted. In the course of the relay operation, closing of the control contact S at any time will cause reset and the operation in the li function will start whereas opening of the control contact S at any time will cause reset and the operation in the lp function will start.

U - supply voltage; R - output state of the relay;
 S - control contact state; T1, T2 - measured time; t - time axis

Single-function Y-D time relay ETR-2T

Technical data

Technical data		ETR-2T
Output circuit		
Number and type of contacts	2 X 1 C0	
Contact material	AgSnO ₂	
Max. switching voltage	300 V AC	
Rated load	AC1: 8 A / 250 V AC DC1: 8 A / 24 V DC; 0,3 A / 250 V DC	
Rated current	8 A / 250 V AC	
Max. breaking capacity	AC1: 2000 VA	
Min. breaking capacity	1 W 10 mA	
Input circuit		
Rated voltage	12...240 V AC/DC AC: 50/60 Hz, (+)A1, (-)A2	
Rated power consumption	≤ 1,5 VA AC AC: 50 Hz ≤ 1,5 W DC	
Insulation (EN 60664-1)		
Insulation rated voltage	250 V AC	
Rated surge voltage	4000 V 1,2 / 50 μs	
Overtoltage category	III	
Insulation pollution degree	2	
Dielectric strength		
• input - output	4000 V AC *	
• contact clearance	1000 V AC **	
• pole - pole	2000 V AC *	
General data		
Electrical life	AC1: > 0,5 x 10 ⁵	
Mechanical life	> 3 x 10 ⁷	
Dimensions (L x W x H)	90*** x 17,5 x 64,5 mm	
Weight	83 g	
Ambient temperature	• storage	-40...+70 °C
	• operating	-20...+50 °C
Cover protection category	IP 20	
Time module data		
Functions	SD	
Time ranges T1 (start-up for the star)	1 s****; 10 s; 30 s; 1 min.; 1,5 min.; 3 min.; 5 min.; 10 min.; 30 min.; 1 h	
Timing adjustment T1 (smooth)	(0,1...1) x time range*****	
Transit time T2 (adjustable)	0,05...0,9 s*****	
Setting accuracy	± 5% *****	
Repeatability	± 0,5% *****	

* Type of insulation: basic.

** Type of clearance: micro-disconnection.

*** Length with 35 mm rail catches: 98,8 mm.

**** For first range setpoint (1 s) setting accuracy and repeatability are smaller than the given ones in technical parameters (significant influence of the operational relay operating time, processor start-time, and the moment of supply switching as referred to the AC supply course).

***** Timing adjustment (smooth): (0,1...1) x time range.

***** Transit time T2 (adjustable): pause time between switching off the star contactor and switching on the delta contactor – smoothly within the range (linear adjustment of time).

***** Calculated from the final range values, for the setting direction from minimum to maximum.

Connection

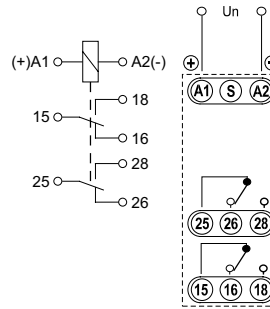

Description

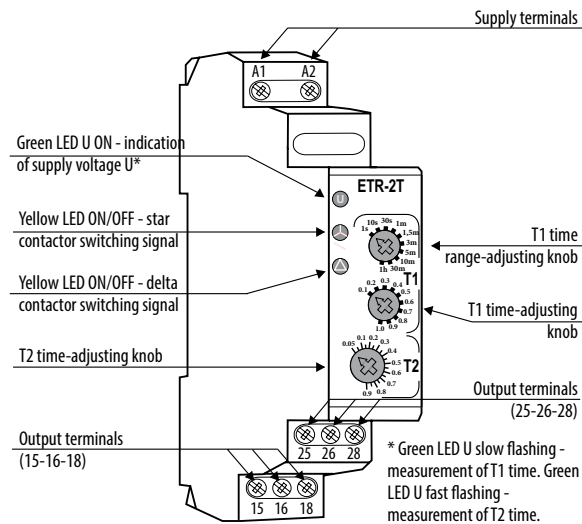

Function

The function changes immediately after it has been selected (without switching power supply off and on again).

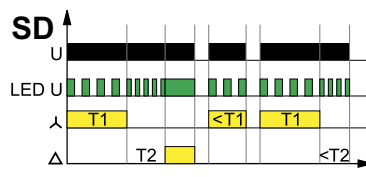

SD) Star-Delta start-up. When the supply voltage U is applied, the operating star-contact (15- 18) becomes closed, which is signaled with illumination of the yellow LED. Measurement of the set time T1 starts, and the green LED slow flashes. After the T1 time has lapsed, the star contact is disconnected and the relay begins measuring the T2 time, which is signaled with the green LED fast flashing. After the T2 time has lapsed, the delta contact (25-28) is switched on together with the yellow LED, and the green LED remains illuminated.

U - supply voltage; T1, T2 - measured times; t - time axis

Technical data

Multifunction staircase time relay ETR-4

Technical data	
ETR-4	
Output circuit	
Number and type of contacts	1 CO
Contact material	AgSnO ₂
Max. switching voltage	300 V AC
Rated load	AC1: 16 A / 250 V AC DC1: 16 A / 24 V DC; 0,3 A / 250 V DC
Rated current	16 A / 250 V AC
Max. breaking capacity	AC1: 4000 VA
Min. breaking capacity	1 W 10 mA
Input circuit	
Rated voltage	230 V AC 50/60 Hz, A1, A2
Rated power consumption	≤ 1,5 VA AC 50 Hz
Input power consumption	≤ 0,7 VA AC 50 Hz
Insulation (EN 60664-1)	
Insulation rated voltage	250 V AC
Rated surge voltage	4000 V 1,2 / 50 μs
Overtoltage category	III
Insulation pollution degree	2
Dielectric strength	
• input - output	4000 V AC *
• contact clearance	1000 V AC **
General data	
Electrical life	AC1: > 0,5 x 10 ⁵
Mechanical life	> 3 x 10 ⁷
Dimensions (L x W x H)	90*** x 17,5 x 64,5 mm
Weight	65 g
Ambient temperature	• storage -40...+70 °C • operating -20...+50 °C
Cover protection category	IP 20
Time module data	
Functions	ON, OFF, AUTO, R, Wi
Time ranges	1 s****; 10 s; 20 s; 30 s; 1 min.; 1,5 min.; 2 min.; 3 min.; 5 min.; 10 min
Timing adjustment (step)	(0,1...1) x time range*****
Setting accuracy	± 5% *****, *****
Repeatability	± 0,5% *****

* Type of insulation: basic.
 ** Type of clearance: micro-disconnection.
 *** Length with 35 mm rail catches: 98,8 mm.
 **** For first range setpoint (1 s) setting accuracy and repeatability are smaller than the given ones in technical parameters (significant influence of the operational relay operating time, processor start-time, and the moment of supply switching as referred to the AC supply course).
 ***** Timing adjustment (step): (0,1...1) x time range
 ***** Calculated from the final range values, for the setting direction from minimum to maximum.

Connection

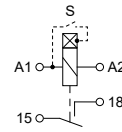

Description

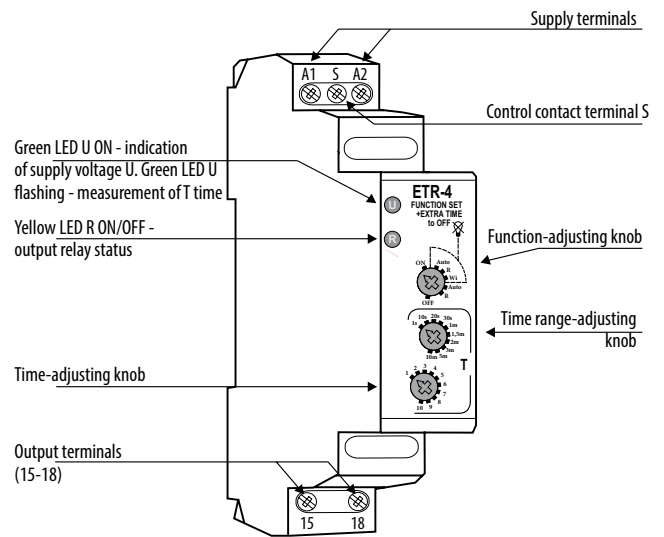

Function

The function changes immediately after it has been selected (without switching power supply off and on again).

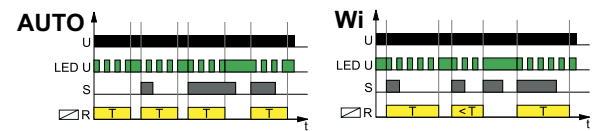
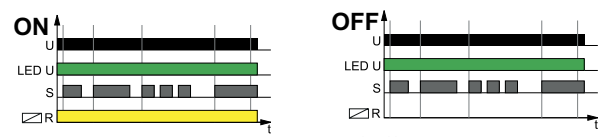

AUTO) ON for a set interval triggered by applying the supply voltage or closing of the control contact S.

Wi) OFF delay with the control contact S.

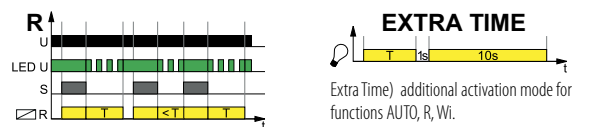

R) ON for the set interval controlled by closing of the control contact S, with the function of switching off the output relay R prior to the lapse of the interval T.

Extra Time) additional activation mode for functions AUTO, R, Wi.

U - supply voltage; R - output state of the relay; S - control contact state; T - measured time; t - time axis

Delay OFF without supply voltage CRM-82TO

Technical data	
	CRM-82TO
Number of functions	a - On Delay (Power On)/ e - Off Delay (S Break)
Supply terminals	A1 - A2
Voltage range	12 - 240 V AC/DC (AC 50 - 60 Hz)
Burden	0.7 - 3 VA AC/ 0.5 - 1.7 W DC
Supply voltage tolerance	-15 %; +10 %
Supply indication	green LED
Time ranges	0.1 s - 10 min
Time setting	potentiometer
Time deviation	5 % - mechanical setting
Repeat accuracy	0.2 % - set value stability
Temperature coefficient	0.01 % / °C, at = 20 °C (0.01 % / °F, at = 68 °F)
Output	
Number of contacts	2x changeover/SPDT (AgNi/ Silver Alloy)
Current rating	8 A / AC1
Breaking capacity	2000 VA / AC1, 192 W / DC
Inrush current	10 A / <3 s
Switching voltage	250 V AC1 / 24 V DC
Min. breaking capacity DC	500 mW
Output indication	red LED
Mechanical life	3x10 ⁷
Electrical life (AC1)	0.7x10 ⁵
Other information	
Operating temperature	-20 °C ... +55 °C (-4 °F ... 131 °F)
Storage temperature	-30 °C ... +70 °C (-22 °F ... 158 °F)
Electrical strength	4 kV (supply-output)
Mounting/DIN rail	DIN rail EN 60715
Protection degree	IP 40 from front panel / IP 10 terminals
Operating position	any
Overvoltage category	III.
Pollution degree	2
Max. cable size(mm ²)	solid wire max. 2x2.5 or 1x4 (AWG 12) with sleeve max. 2x1.5 or 1x2.5 (AWG 12)
Dimensions	90 x 17.6 x 64 mm (3.5" x 0.7" x 2.5")
Weight	93 g (3.3 oz.)
Standards	EN 61812-1, EN 61010-1

Symbol

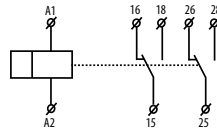

Connection

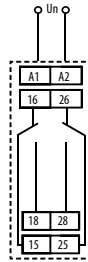

Description

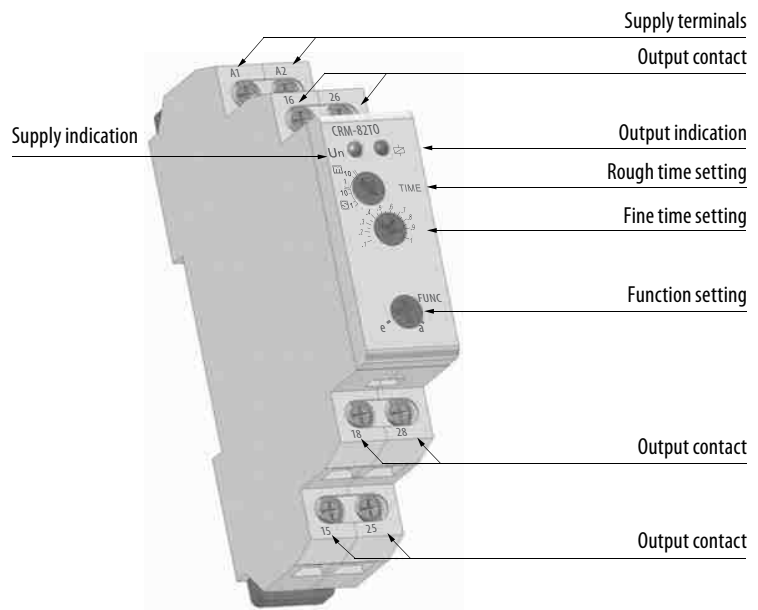

Function

a - Delay OFF (S break) the power supply is switched off (min. time is 0.5 s)



e - ON Delay



Technical data

Multifunction time relay CRM-91H, CRM-93H

Technical data	
	CRM-91H CRM-93H
Number of functions	10
Supply	A1-A2
Supply voltage	12-240 V AC/DC(50-60 Hz AC)
Consumption	AC 0,7-3 VA / DC 0,5 - 1,7 W
Supply indication	green LED
Time ranges	0.1 s-10 days
Time settings	rotary switch
Time deviation	5%-mechanical setting
Repeat accuracy	0,2%-set value stability
Temperature coefficient	0,01% / °C at 20 °C
Output	
Changeover contacts	1 3
Rated current	16 A / AC1 8 A / AC1
Breaking capacity	4000 VA / AC1, 2000 VA / AC1, 384 W / DC 192 W / DC
Inrush current	30 A / <3 s 10 A / <3 s
Switching voltage	250 V AC1 / 24 V DC
Min. breaking capacity DC	500 mW
Output indication	multifunction red LED
Mechanical life	3x10 ⁷
Electrical life	0,7x10 ⁵
Controlling	
Controlling voltage	12-240 V AC/DC
Consumption of output	0,025-0,2 VA AC/ 0,1-0,7 W DC
Load between S-A2	✓
Glow-tubes	✗
Control. terminals	A1-S
Impulse length	min. 25 ms/ max. unlimited
Reset time	max. 150 ms
Operating temperature	-20...+55 °C
Storing temperature	-30...+70 °C
Electrical strength	4 kV
Operating position	any
Mounting	DIN rail EN 60715
Protection degree	IP 40 from frontal panel
Overvoltage category	III.
Pollution degree	2
Max. cable size	2.5 mm ²
Dimensions	90 x 17,6 x 64 mm
Standards	EN 61812-1, EN 61010-1

Connection

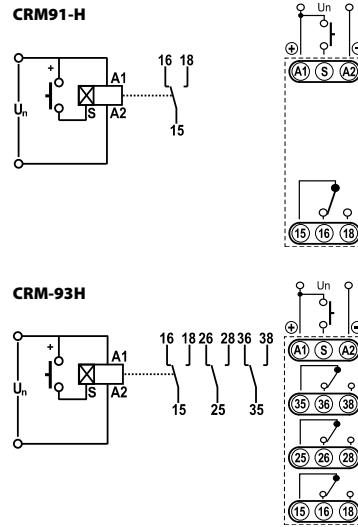

Load with control input possible.

Load between S-A2 possible to connect in parallel way, without disturbing of proper operation of the relay.

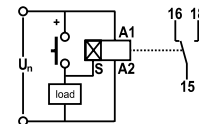

Dimensions

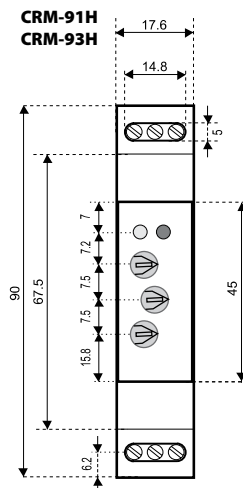

1-module design

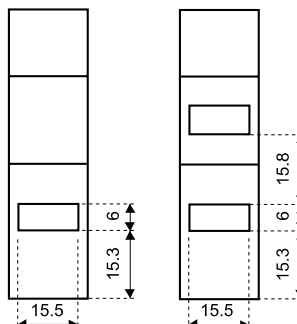
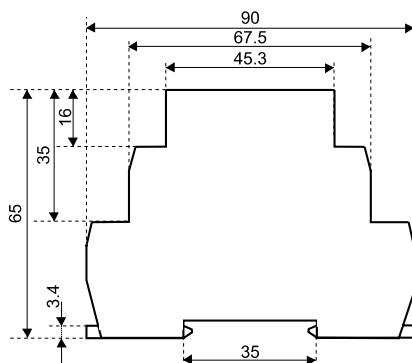

Functions

- a) Delay ON after energisation
- b) Delay OFF after energisation
- c) Cycler beginning with pause after energisation
- d) Cycler beginning with impulse after energisation
- e) Delay OFF after de-energisation, instant make of output
- f) Delay OFF responding to make of control contact regardless its length
- g) Delay OFF after break of control. contact with instant output
- h) Delay OFF after make and break of control. contact
- i) Memory (latching) relay
- j) Pulse generator

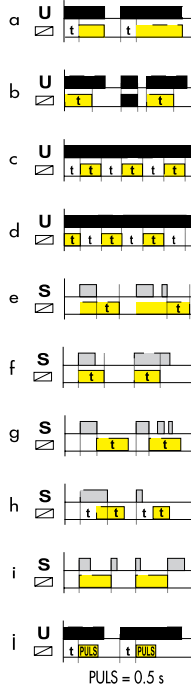

Time ranges

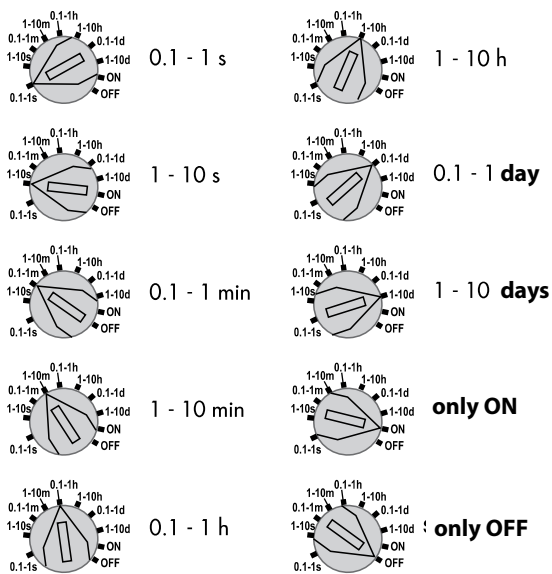

Description

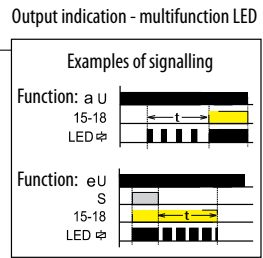
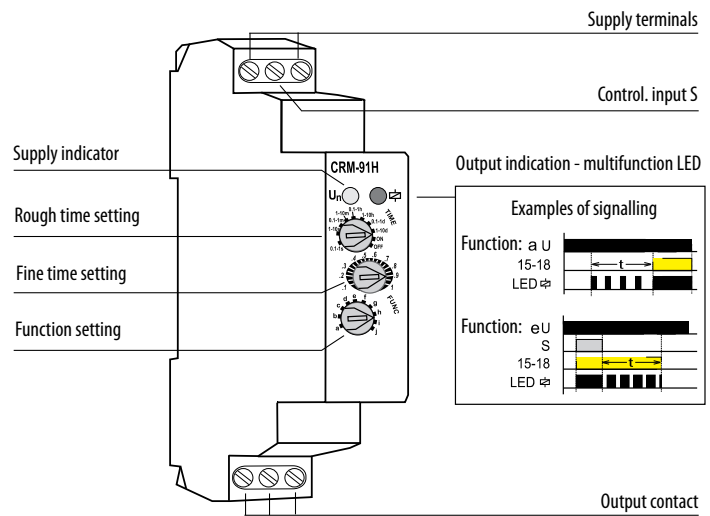

Delay ON star/delta CRM-2T

Technical data	
	CRM-2T
Number of functions	1
Supply	A1-A2
Universal supply	AC/DC 12-240 V (AC 50-60 Hz)
Consumption	AC 0,7-3VA/DC 0,5-1,7 W
Supply voltage tolerance	-15% - +10%
Supply indication	green LED
Time ranges	t1: 0.1 s - 100 days
Time setting	rotary switch and potentiometer
Time deviation	5%-mechanical setting
Repeat accuracy	0,2%-set value stability
Temperature coefficient	0,01% / °C at 20 °C
Output	
Number of contacts	2 x changeover (AgNi)
Rated current	16 A / AC1
Breaking capacity	4000 VA / AC1, 384 W / DC
Inrush current	30A/<3s
Switching voltage	max. 250 V AC1 / 24 V DC
Min. breaking capacity DC	500 mW
Output indication	multifunction red LED
Mechanical life	3x10 ⁷
Electrical life	0.7x10 ⁵
Reset time	max. 150 ms.
Controlling	
Operating temperature	-20...+55 °C
Storage temperature	-30...+70 °C
Electrical strength	4 kV
Operating position	any
Mounting	DIN rail EN 60715
Protection degree	IP 40 from front panel
Overtoltage category	III.
Pollution degree	2
Max. cable size	2.5 mm ²
Dimensions	90 x 17,6 x 64 mm
Standards	EN 61812-1, EN 61010-1

Connection

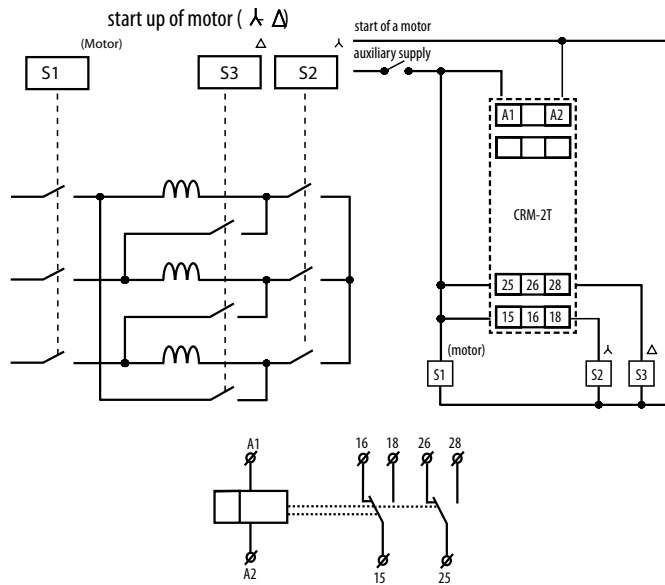

Functions

Delay ON star/delta

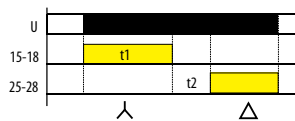

Description

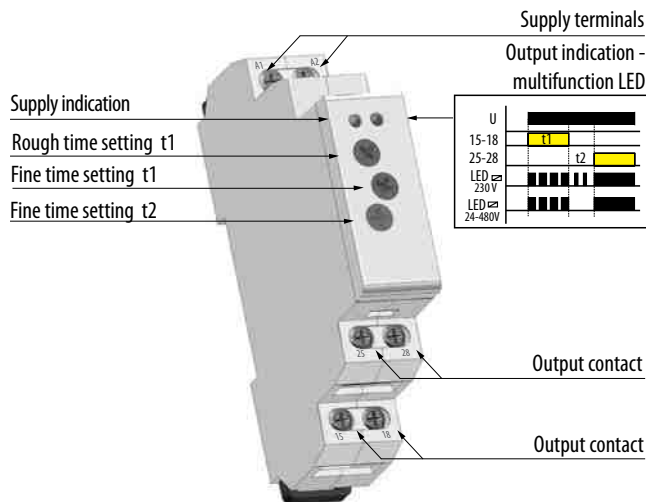

Time ranges

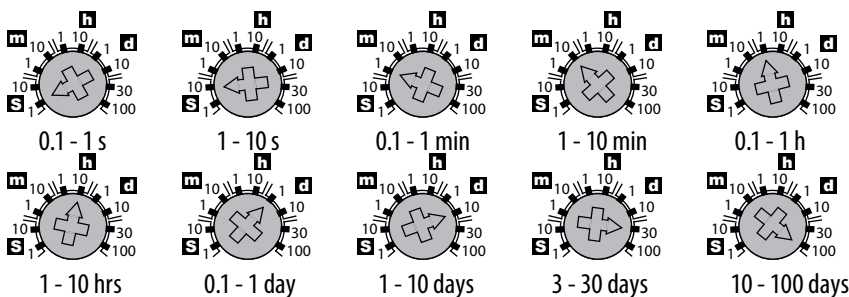

Technical data

Staircase switch CRM-4

Technical data

Function	delay OFF
Supply	A1-A2
Supply voltage	230 V AC/50-60 Hz
Consumption	max. 12 VA AC/1.8 W
Supply voltage tolerance	- 15%; + 10%
Supply indication	green LED
Time ranges	0,5 - 10 min
Time setting	potentiometer
Time deviation	10% mechanical setting
Repeat accuracy	5% set value stability
Temperature coefficient	0,05% / °C -> 20 °C
Output	
Changeover contacts	1
Rated current	16 A / AC1
Breaking capacity	4000 VA / AC1, 384 W / DC
Inrush current	30 A / <3 s
Switching voltage	250 V AC1 / 24 V DC
Min. breaking capacity DC	500 mW
Output indication	red LED
Mechanical life	3x10 ⁷
Electrical life	0,7x10 ⁵
Controlling	
Control. voltage	230 V AC
Consumption of input	0,53 VA AC
Load between S-A2	yes
Glow-tubes	yes, max. 20 pcs. (at 1 mA)
Control. terminals	A1-S
Impulse length	min. 25 ms/max. unlimited
Reset time	max. 150ms
Operating temperature	-20...+55 °C
Storage temperature	-30...+70 °C
Electrical strength	4 kV (supply - output)
Operating position	any
Mounting	DIN rail EN 60715
Protection degree	IP 40 from frontal panel
Overtoltage category	III
Pollution degree	2
Max. cable size	2,5 mm ²
Dimensions	90x17, 6x64 mm
Standards	EN 60669-2-3, EN 61010-1

Connection

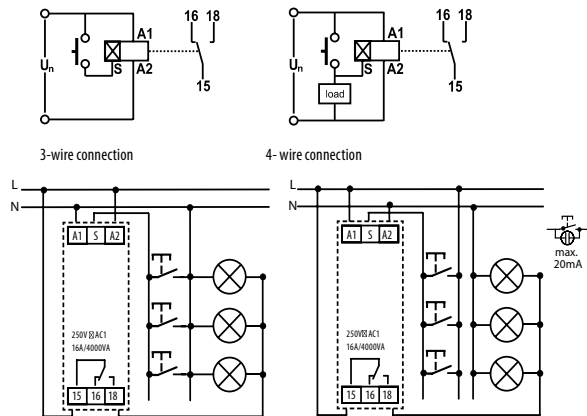

Description

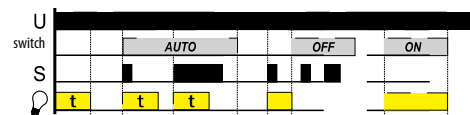
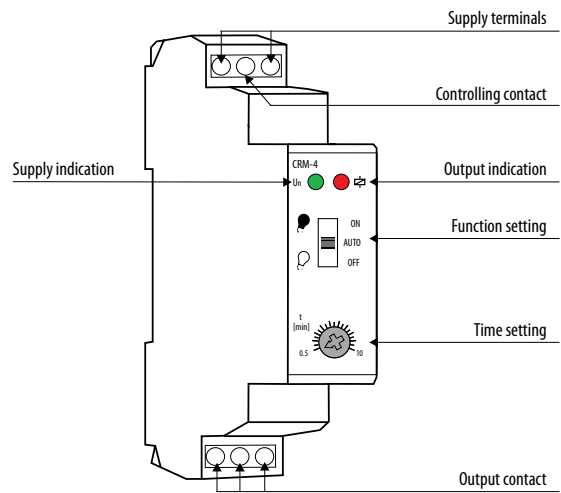

Dimensions

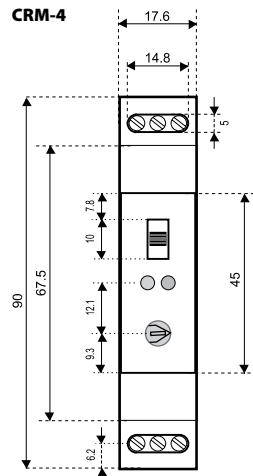

1-module design

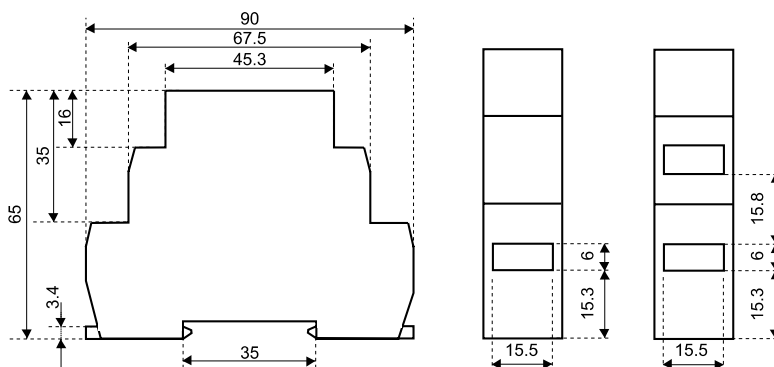

Programmable staircase switch CRM-42

Technical data	
CRM-42	
Functions	delay OFF responsive to control contact switch on
Supply	A1-A2
Supply voltage	230V AC / 50-60Hz
Consumption	max. 12VA AC / 1.8 W
Supply voltage tolerance	-15% - +10%
Supply indication	green LED
Time ranges	0.5 - 10 min.
Time setting	potentiometer
Time deviation	5%-mechanical setting
Repeat accuracy	5%-set value stability
Temperature coefficient	0,05% / °C at 20 °C
Output	
Number of contacts	1, (AgSnO ₂), switching potential A1
Rated current	16 A / AC1
Breaking capacity	4000 VA / AC1, 384W / DC
Inrush current	30A / < 3s.
Switching voltage	max. 250 V AC1 / 24 V DC
Min. breaking capacity DC	500 mW
Output indication	red LED
Mechanical life	3x10 ⁷
Electrical life	0.7x10 ⁵
Reset time	max. 150 ms.
Controlling	
Control Voltage	230 V AC
Input consumption	0.53 VA AC
Glow tubes	yes, max. 100 pcs. (at 1mA)
Control terminals	A1-S / A2-S
Impulse length	min 50ms. / max.unlimited
Reset time	max. 150 ms.
Operating temperature	-20...+55 °C
Storage temperature	-30...+70 °C
Operating position	any
Mounting	DIN rail EN 60715
Protection degree	IP 40 from front panel
Overvoltage category	III.
Pollution degree	2
Max. cable size	2.5 mm ²
Dimensions	90 x 17,6 x 64 mm
Standards	EN 60669-2-3, EN 61010-1

Connection

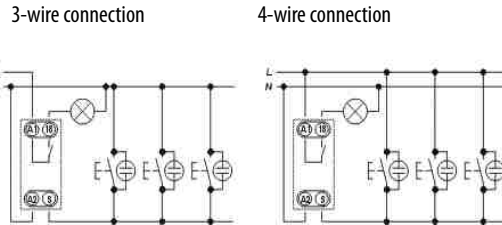

Functions

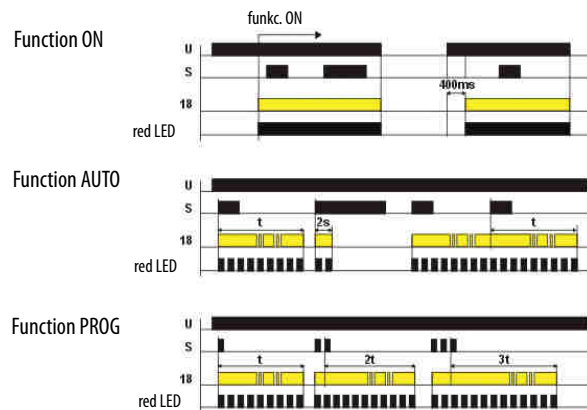

Description

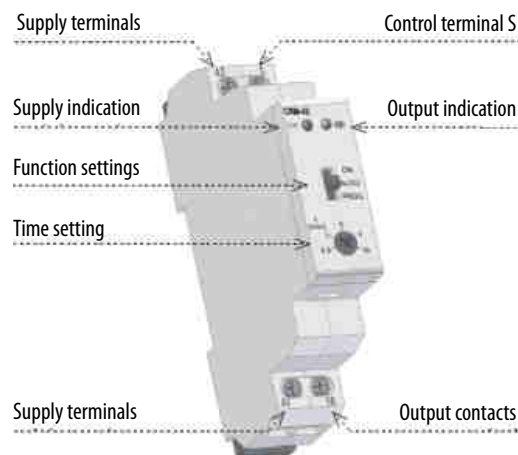

Technical data

Digital time switch SHT-1, SHT-1/2, SHT-3 and SHT-3/2

Technical data	
Supply terminals	A1-A2
Supply voltage	UNI 12 - 240 V AC/DC (50 AC - 60 Hz)
Consumption	0,5 - 2 VA AC/ 0,4 - 2 W DC
Supply voltage	230 V AC/50 - 60 Hz
Consumption	max. 14 VA AC / 2 W
Supply voltage tolerance	-15%; +10%
Back-up supply	yes
Summer/winter time	automatic
Output	
Number of contacts	1x CO → SHT-1, SHT-3; 2X CO → SHT-1/2, SHT-3/2
Rated current	16 A / AC1
Breaking capacity	4000 VA / AC1, 384 W / DC
Inrush current	30 A / < 3 s
Switching voltage	250 V AC1 / 24 V DC
Min. breaking capacity DC	500 mW
Mechanical life	>3x10 ⁷
Electrical life (AC1)	>0,7x10 ⁵
Time circuit	
Power back-up	3 years
Accuracy	max. +/- 1s/dat / 23°C
Minimum interval	1 s
Data stored for	min. 10 years
Program circuit	
Program SHT-1, SHT-1/2	daily, weekly
Program SHT-3, SHT-3/2	daily, weekly, monthly, yearly
Data readout	LCD display
Other information	
Operating temperature	-20...+55°C
Storage temperature	-30...+70°C
Electrical strength	4 kV (supply-output)
Operating position	any
Mounting	DIN rail EN 60715
Protection degree	IP 20
Overvoltage category	III
Pollution degree	2
Max. cable size	max. 2x1,5 mm ² , 2x2,5 mm ²
Dimensions	90x35, 6x64mm
Standards	EN 61812-1, EN 61010-1

Controlling elements

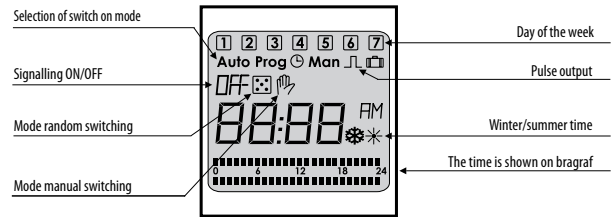

Description

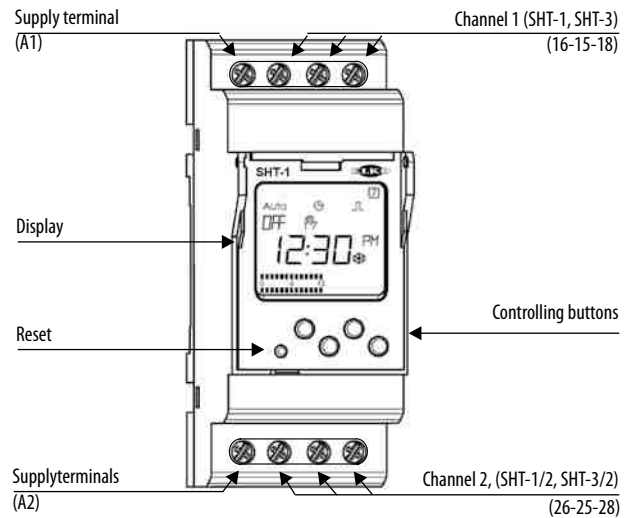

Connection

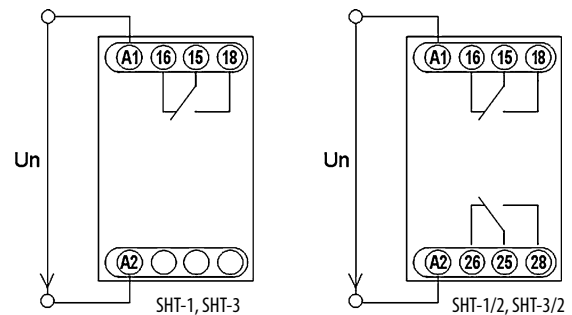

Dimensions

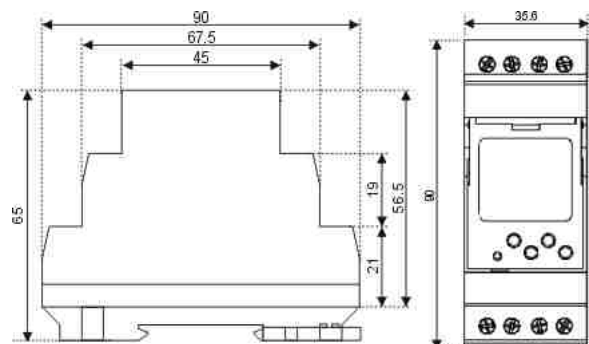

Analog electromechanical time switch APC-D1, APC-DR1

Technical data		
	APC-DR1	APC-D1
Supply voltage	230V AC	230V AC
Power reserve	yes (100 hrs)	no
Dial/minimum switching time	15 min	15 min
Operating accuracy	+/- 1s/day at 22°C	+/- 1s/day at 22°C
Program	Daily	Daily
Output contact	1 x NO	1 x NO
Switching capability	16A 125/250V AC1	16A 125/250V AC1
Power consumption	0,5W	0,5W
Operating temperature	-25...+55°C	-10...+45°C
Mounting	DIN rail EN 60715	DIN rail EN 60715
Protection category	IP20	IP20
Overvoltage category	II.	II.
Dimensions	90 x 17,5 x 66	90 x 17,5 x 66
Standards	EN 60730-2-7	EN 60730-2-7

Dimensions

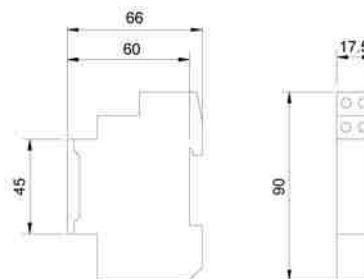

Connection

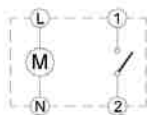

Programming

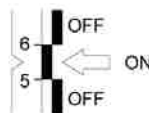

Multifunction relays SMR-T, SMR-H, SMR-B

Technical data			
	SMR-T	SMR-H	SMR-B
Number of functions	9	9	10
Connection	3-wires, without neutral	4-wires, with neutral	4-wires, with neutral
Supply voltage	230 V AC / 50-60 Hz		
Consumption (no operation/make)	0,8/3 VA	0,8/3 VA	3 VA
Supply voltage tolerance	- 15%; + 10%		
Time ranges	0,1 s-10 days	0,1 s-10 days	x
Time setting via	via rotary switch and potentiometer	via rotary switch and potentiometer	x
Time deviation	10% mechanical setting	10% mechanical setting	x
Repeat accuracy	2% set value stability	2% set value stability	x
Temperature coefficient	0,1%, °C at 20 °C	0,1%, °C at 20 °C	x
Output	1x triac		1xNO (AgSnO2)
Resistive load	10-160 VA	0-200 VA	16A 125/250 V AC1
Inductive load	10-100 VA	0-100 VA	8A 250 V AC (cos fi > 0,4)
Controlling			
Voltage	230 V AC		
Current	3 mA		
Impulse length	min. 50 ms/ max. unlimited		
Operating temperature	0...+50 °C		
Operating position	any		
Mounting	free at connecting wires		
Protection degree	IP 30 from front panel		
Overvoltage category	III		
Pollution degree	2		
Fuse	F1 A / 250 V	F1 A / 250 V	F1,6 A / 250 V
Outlets	3 x solid wires 0,75 mm ² length 90 mm		
Glow-laps in button (pcs)	max. 10		
Dimensions	48,5 x 48,5 x 13 mm		
Standards	EN 61010-1		

Technical data

Function

Function a - delay off on entering edge
output times when it is switched. Each following pressing (max. 5x) increases time
Long pressing switches output off

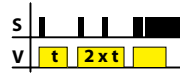

Function b - delay off on downward edge
output times after button is switched off, switches immediately

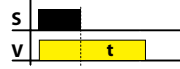

Function c - delay off on downward edge
after switching off output switches on and times.



Function d - cycler - flasher impulser
output cycles in regular interval, cycler starts with an impulse



Function e - puls shift
delay on after the switch is switched on and delay on after it is switched off



Function f - delay on
delay on after switch is switched on until it is switched off



Function g - pulse relay
switches on by a press, another pressing switches the output off. The length of pressing doesn't matter, it is possible to set reaction delay by a potentiometer and thus eliminate rebound of a button

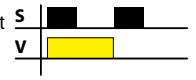

Function h - impulse relay with delay
one press switches on, another one switches the output off in case it is done before the end of timing

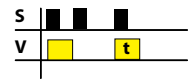

Function i - delay on after switched off
output cycles in regular intervals, cycler starts with a gap



Function j *- cycler starting with gap
delay on after switching on until it is de-energized or a switch is pressed again.



*function j is valid only for SMR-B

Time ranges

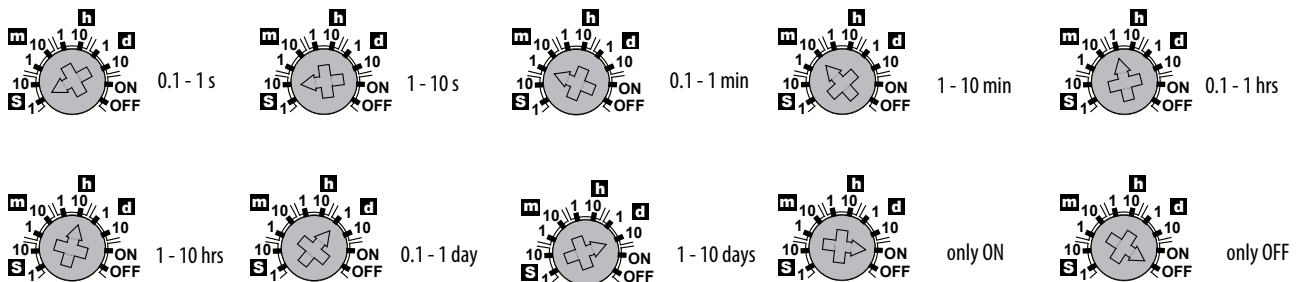

Connection SMR-B, SMR-H, SMR-T

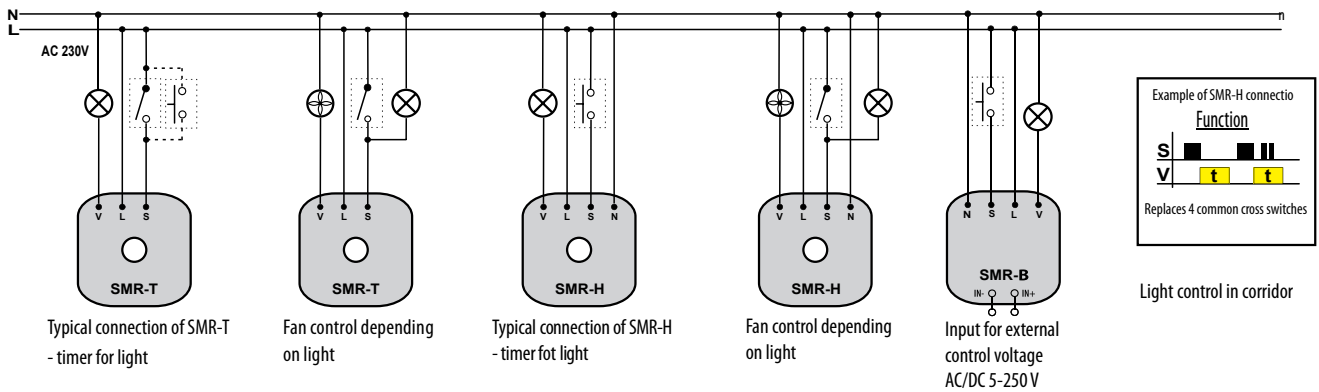

Description

SMR-T, H

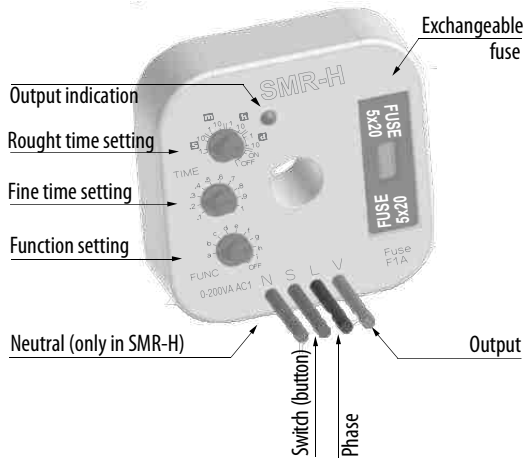

SMR-B

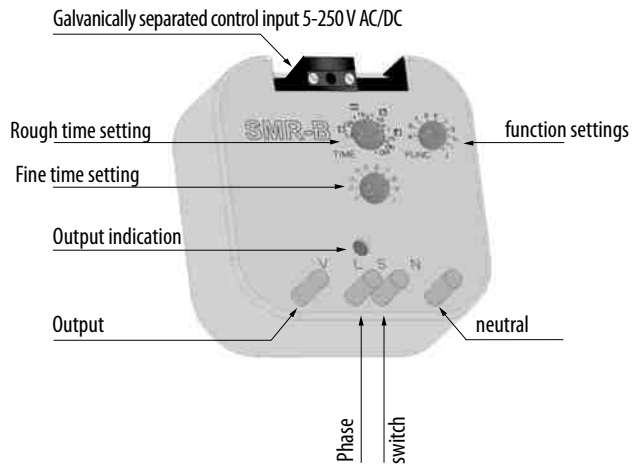

Dimension

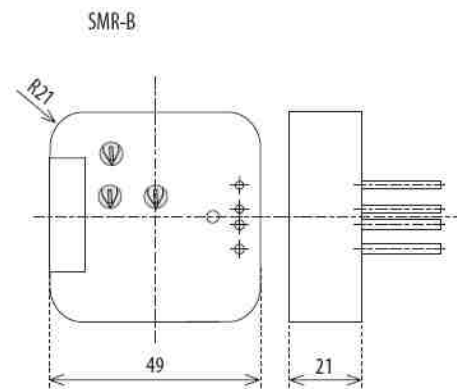
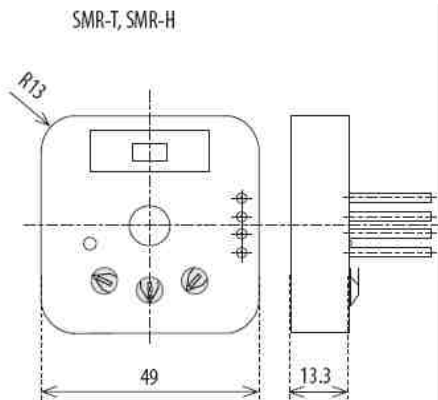

Technical data

Dimmer flush mounting SMR-S, SMR-U

Technical data		
	SMR-S	SMR-U
Connection	4-wire without neutral	4-wire with neutral
Supply voltage	AC 230 V / 50-60 Hz	
Consumption (no operation/make)	max. 3VA	
Supply voltage tolerance	- 15%; + 10%	
Output		
Resistive load	10-300 VA	500 VA*
Capacitive load	10 -150VA	500 VA*
Inductive load	x	500 VA*
Controlling		
Control Voltage	AC 230 V	
Current	3 mA	
Impulse length	min. 50 ms/ max. unlimited	
Operating temperature	0...+50 °C	
Operating position	any	
Mounting	free of connecting wires	
Protection degree	IP30 from front panel	
Overvoltage category	III	
Pollution degree	2	
Fuse	F 1.6A/ 250V	x
Output	solid 0,75 mm ² , length 90 mm	
Glow-lamps in control button	max. 10 pcs.	
Dimensions	49x49x13 mm	
Standards	EN 60669-2-1, EN 61010-1	

Functions

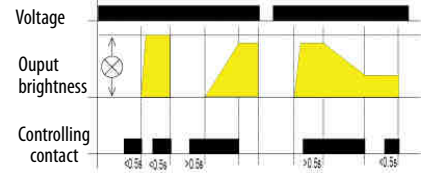

KA short press (<math><0.5s</math>) turns a light on, another short press turns it off. A longer press (>0.5s) causes a gradual regulation of light intensity min-max-min round until the button is released. After releasing a set intensity is kept in memory, further short presses turn the light on/off keeping the set intensity. The intensity can be changed by further long press. After de-energising the relay remembers the set value.

*When load is above 300 VA it is necessary to ensure sufficient cooling; see instruction manual technical data

Warning: it cannot be used for fluorescent lights and energy saving lights!
SMR-U: It is not allowed to connect together loads of inductive and capacitive type at the same time

Connection SMR-S, SMR-U

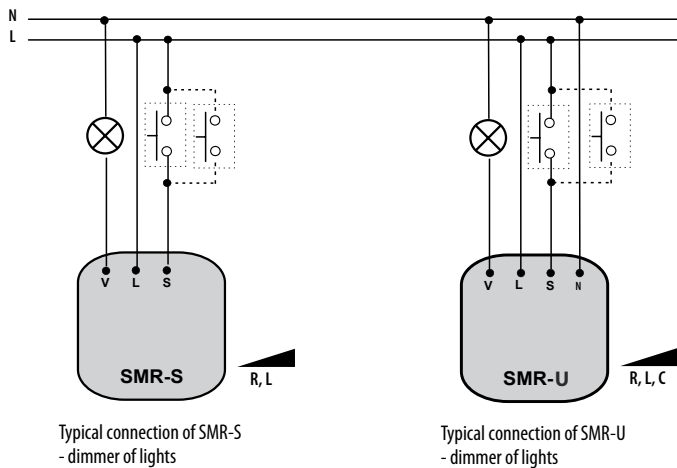

Typical connection of SMR-S - dimmer of lights

Typical connection of SMR-U - dimmer of lights

Warning: it cannot be used for fluorescent lights and energy saving lights!
SMR-U: It is not allowed to connect together loads of inductive and capacitive type at the same time

Dimensions

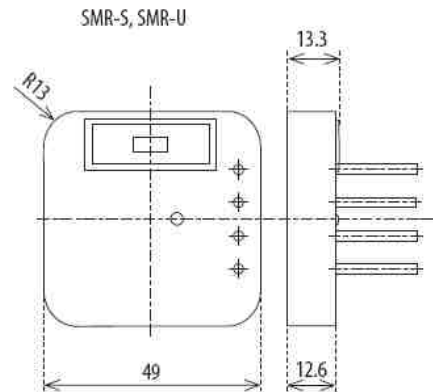

Description SMR-S

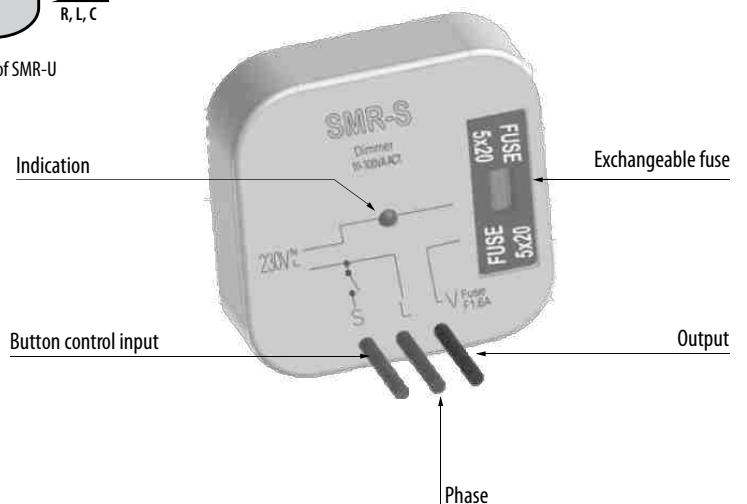

Twilight switch in IP65 ETS-16b

Technical data	
	ETS-16b
Voltage	230 V AC
Time delay	cca 20s
Light level	2-50 Lx
The number and types of contacts	1 NO - NO
Rated current contact	16A/AC1
Installation	on a flat surface
Standards	EN 61812-1, EN 50081, EN 61000
Power supply range	180 - 240 V AC 50Hz
Max load current (AC-1)	16 A
Switch ON treshold	10 lux
Switch off treshold	20 lux
Time delay of switch ON or OFF	cca 20 s
Adjustment range	cca 2 - 200 lux
Working temperature	- 40°C ... +50 °C
Protection class	IP65

Connection

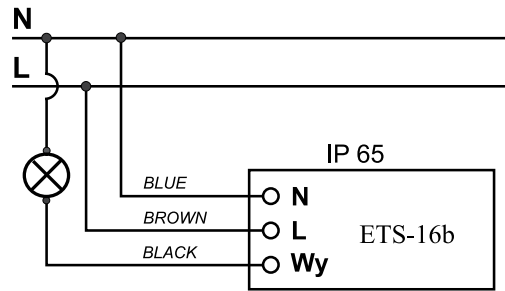

Setting

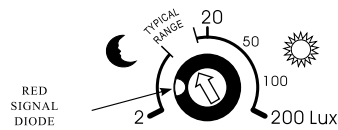

Dimensions

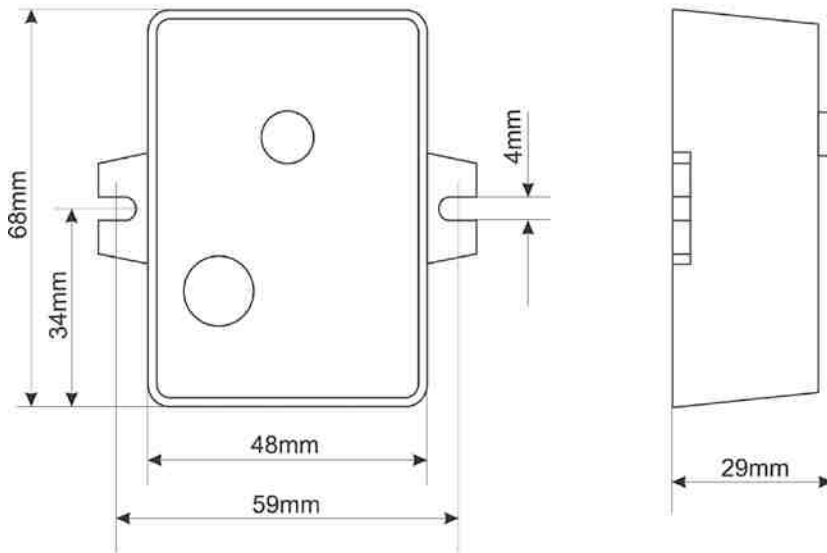

Technical data

Memory and latching relays MR-41, MR-42

Technical data

	MR-41	MR-42
Number of functions	1	2
Supply	A1-A2	
Supply voltage UNI	12-240 V AC/DC (50-60 Hz AC)	
Consumption UNI	AC 0,17-3 VA / DC 0,5 - 1,2 W	AC 0,17-12 VA / DC 0,11 - 1,9 W
Supply voltage 230	230 V AC / 50-60 Hz	
Consumption 230	AC max. 12 VA / DC 1,2 W	AC max. 12 VA / DC 1,9 W
Supply indication	green LED	
Output		
Supply voltage tolerance	- 15%; + 10%	
Number of contacts	1xCO	2xCO
Rated current	16 A / AC1	2x16 A / AC1
Breaking capacity	4000 VA / AC1, 384 W / DC	4000 VA / AC1, 2x384 W / DC
Inrush current	30 A / <3 s	30 A / <3 s
Switching voltage	250 V AC1 / 24 V DC	250 V AC1 / 24 V DC
Min. breaking capacity DC	500 mW	500 mW
Output indication	red LED	red LED
Mechanical life	3x10 ⁷	
Electrical life	0,7x10 ⁵	
Controlling		
Voltage	12-240 V AC/DC	
Consumption of input	AC 0,025-0,2 VA / DC0,1-0,7 W (UNI) , AC 0,53 VA (AC 230V)	
Load between A2 ON/OFF	yes	
Glow-lamps	no (UNI) , yes -max. 4 pcs at 1mA (AC 230V)	
Control terminals	A1 ON/OFF	
Max. capacity of cable control:		
-without connected glow lamps	12 nF (UNI) , 12nF (230V)	
-with connected glow lamps	9nF (UNI) , glow lamps cannot connected/NO 9nF (230V) , max. 4pcs (1pc-1mA)	9nF (UNI) , glow lamps cannot connected/NO 9nF (230V) , max. 4pcs (1pc-1mA)
Impulse length	min. 25 ms/ max. unlimited	
Operating temperature	-20...+55°C	
Storage temperature	-30...+70°C	
Electrical strength	4 kV (supply - output)	
Operating position	any	
Mounting	DIN rail EN 60715	
Protection degree	IP 40 from frontal panel	
Overtoltage category	III	
Pollution degree	2	
Max. cable size	2,5 mm ²	
Dimensions	90x17, 6x64 mm	
Standards	EN 60669-2-2, EN 61010-1	

Connection

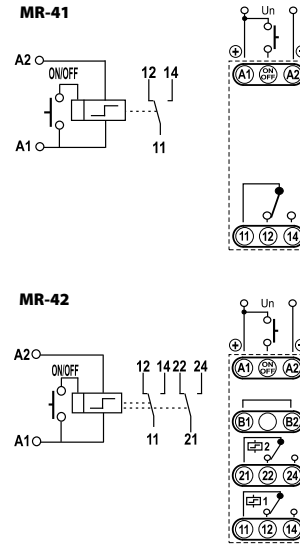

Dimensions

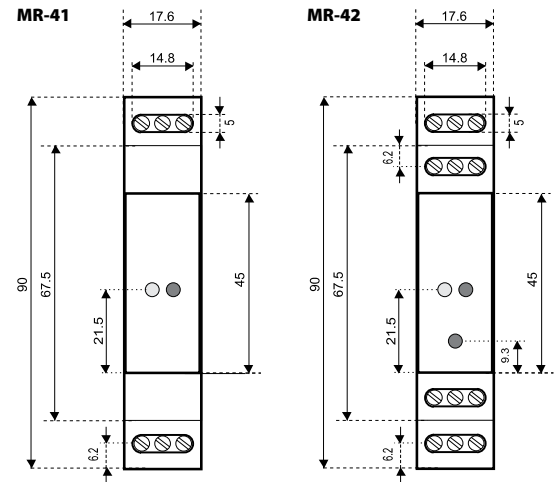

1-module design

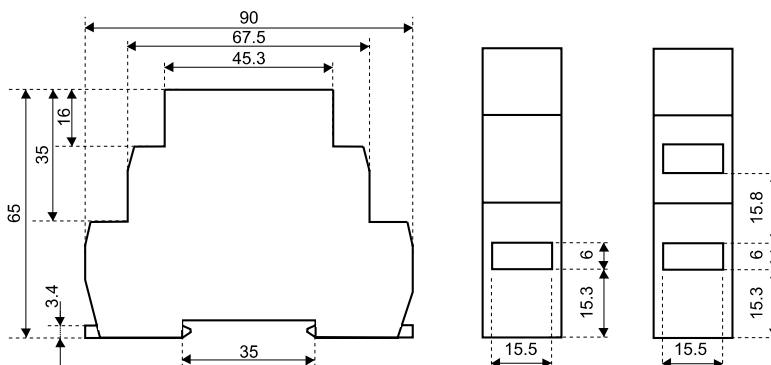

Function

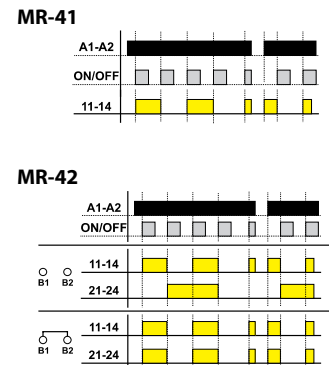

Staircase switch with dimming DIM-2

Technical data

Supply	A1-A2
Supply voltage	230 V AC (50 Hz)
Consumption	max. 5 VA
Supply voltage tolerance	- 15%; + 10%
Supply indication	green LED
Time setting via	potentiometer
Time deviation	10% mechanical setting
Repeat accuracy	5% set value stability
Temperature coefficient	0,01% / °C / 20 °C

Controlling T1

Terminals	T1-A1
Voltage	230 V AC
Power on control input	max. 1,5 VA
Impulse length	min. 100 ms / max. unlimited
Glow-lamps	yes, max. 5 pcs (at 1 mA)

Controlling T2

Terminals	T2-A1
Voltage	230 V AC
Power control input	max. 0,1 VA
Impulse length	min. 100 ms / max. unlimited
Glow-lamps	no
Output	contactless - triac
Rated current	2 A
Resistive load	10-500 VA
Inductive load	10-250 VA
Operating temperature	-20...+55 °C
Storage temperature	-30...+70 °C
Operating position	any
Mounting	DIN rail EN 60715
Protection degree	IP 40 from front panel
Overvoltage category	III
Pollution degree	2
Max. cable size	2,5 mm ²
Dimensions	90x17,6x64 mm
Standards	EN 60669-2-1, EN 61010-1

Connection

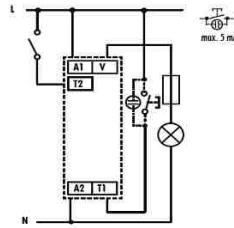

Function

Controlled via input T1 (button)

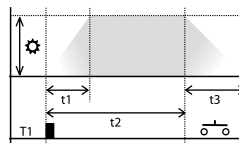

Controlled via input T2 (switch)

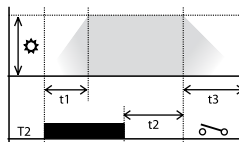

Cycle dim-up time is activated by pressing the button; By repressing the button (during the cycle) it is possible to prolong the time of the cycle.

Legend:

- ⚙ Output / Brightness: 10-100%
- t1 Dim-up time: 1-40 s
- t2 Time delay: 0s-20min
- t3 Dim-down time: 1-40s
- T1/T2 Controlling contact

The cycle is started by activating the switch and breaks on max. adjusted brightness level. After the switch is turned off the switch cycle is complete.

Description

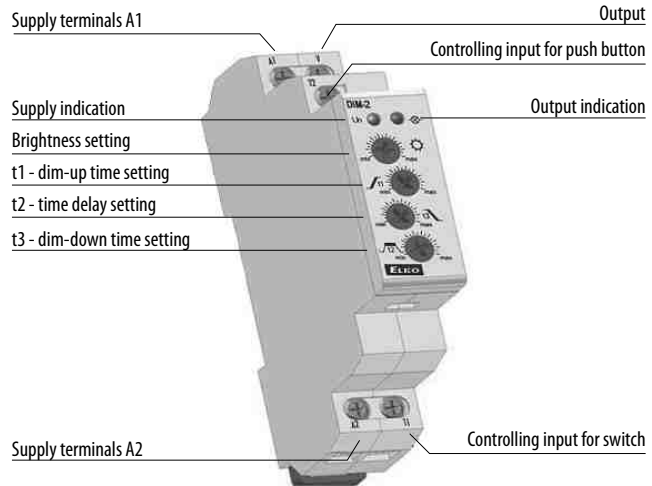

Dimensions

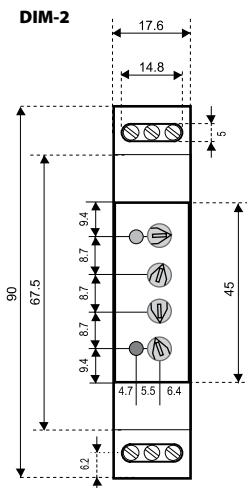

1-module design

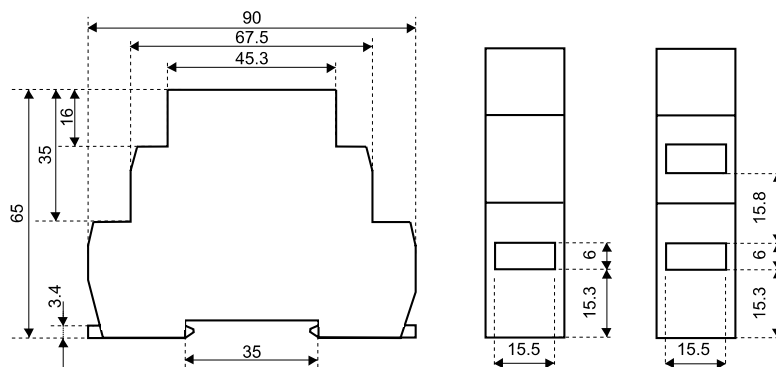

Technical data

Dimmer DIM-14

Technical data	
DIM-14	
Supply	A1-A2
Supply voltage	230 V AC (50 Hz)
Consumption	1,3 W
Supply voltage tolerance	- 15%; + 10%
Supply indication	green LED
Indication output	6 VA
Controlling	
Terminals	T1-A1
Control Voltage	230 V AC
Power control input	0,3 - 0,6 VA AC
Impulse length	min. 80 ms / max. unlimited
Glow-lamps in control button	yes, max. 5 pcs. (at 1 mA)
Output	2 x MOSFET
Rated current	2 A
Resistive load	500 VA*
Inductive load	500 VA*
Capacitive load	500 VA*
Output indication	red LED
Operating temperature	-20...+35 °C
Storage temperature	-20...+60 °C
Operating position	any
Mounting	DIN rail EN 60715
Protection degree	IP 40 from front panel
Overvoltage category	III
Pollution degree	2
Max. cable size	2,5 mm ²
Dimensions	90x17,6x64 mm
Standards	EN 60669-2-1, EN 61010-1

* When load is above 300 VA it is necessary to ensure sufficient cooling

Recommendation for mounting: leave a gap of min. 0,5 module (approx. 9 mm) on side of the device to ensure better cooling of the device.

Warning for DIM-14: it is not allowed to connect together loads of inductive and capacitive type at the same time

Connection

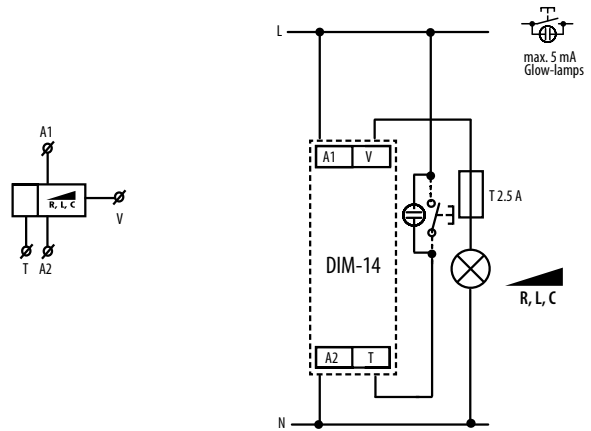

Functions

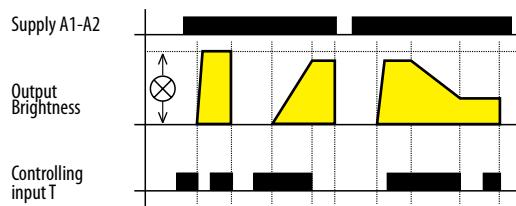

Description

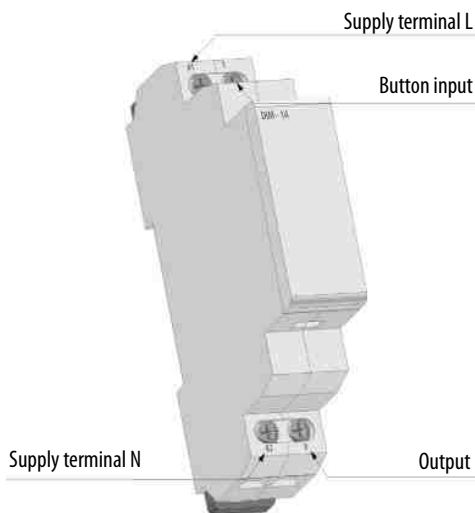

Dimmers for LED bulbs and dimmable fluorescent lamps DIM-15 and SMR-M

Technical data		
	DIM-15	SMR-M
Supply voltage	AC 230V / 50-60 Hz	
Supply voltage tolerance	-15%; +10%	
Apparent power	max. 1.5VA	
Loss power	max. 0.7W	
Supply indication	green LED	
Controlling		
Control terminals	x	L - S
Control wire	AC 230V	
Control voltage	AC 0.3-0.6 VA	
Control input power	min. 80 ms / unlimited	
Control impulse length	Yes	
Glow tubes connection	230V - max. 15pcs	230V - max. 10pcs
Max. amount of glow lamps connected to controlling input	(measured with glow lamp 0.68mA/230VAC)	(measured with glow lamp 0.68mA/230VAC)
Output		
Contactless	2 x MOSFET	
Load*	300W (at cos φ=1)	160W (at cos φ=1)
Output status indication	red LED	x
Other data		
Operating temperature	-20C ... +35C	
Storing temperature	-20C ... +60C	
Operating position	any	
Mounting	DIN rail EN 60715	free at connection wires
Protection degree	IP40 from front panel / IP10 terminals	IP30 in standard conditions
Overvoltage category	III.	
Pollution level	2	
Terminal wires	max. 2x2.5; with sleeve 1x1.5mm ²	x
Dimensions	90 x 17.6 x 64 mm	49 x 49 x 21 mm
Weight	57 g	38 g
Standards	EN 60669-2-1, EN 61010-1	

* Due to a large number of light source types, the maximum load depends on the internal construction of dimmable LEDs and ESL bulbs and their power factor cos φ. The power factor of dimmable LEDs and ESL bulbs ranges from cos φ = 0.95 to 0.4. An approximate value of maximum load may be obtained by multiplying the load capacity of the dimmer by the power factor of the connected light source.

Connection

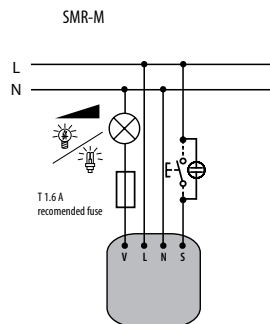
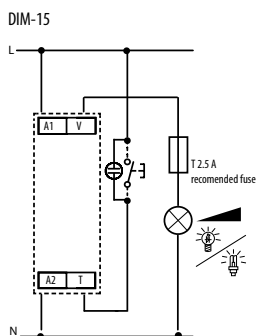

Light source type setting

dimmable saving fluorescent lamps



LED bulbs



Technical data

Functions and controlling

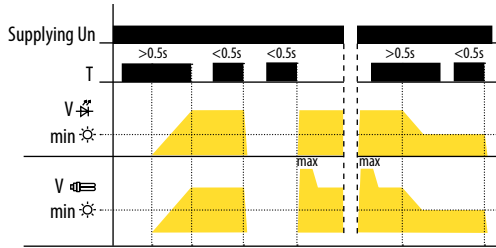

Controlling:

- short button press (<0.5s) turns the light off or on
- long press (>0.5s) enables slight regulation of light intensity
- setting of minimal luminance is possible only during decreasing of luminance by long button press

Devices description

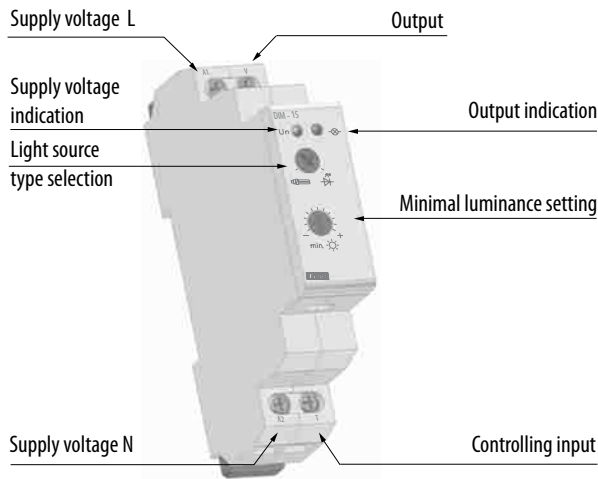

Minimal luminance setting:

LED bulb:

- if the light is turned off, short press (<0.5s) switches the light onto last set luminance level

Saving fluorescent lamp:

- if the light is turned off, short press increases the luminance onto maximal level (saving fluorescent lamps fires up) and then luminance decreases onto set level
- setting of minimal luminance by saving fluorescent lamps serves for harmonizing of lowest light intensity prior its unprompted switching off

Additional information

- it is possible to dim only LED bulbs equipped with capacitor supplying
- it is not possible to dim saving fluorescent lamps without marking: dimmable
- an incorrect setting of light source has effect only on dimming range, it means neither dimmer or load get damaged
- maximal load is counting with usage of LC filter

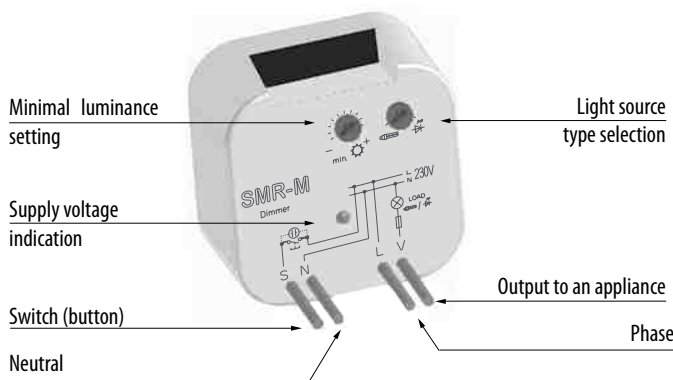

Twilight switch SOU-1 + sensor

Technical data	
Supply	A1-A2
Supply voltage AC 230	230 V AC (50-60 Hz)
Consumption AC 230	max. 12 VA AC / 1,8 W
Supply voltage tolerance	- 15%; + 10%
Supply indication	green LED
Time dwell	0-2 min
Time dwell setting	potentiometer
Measuring range 1)	1-100 Lx
Measuring range 2)	100-50000 Lx
Output	
Number of contacts	1xCO
Rated current	16/AC1
Breaking capacity	4000 VA/AC1, 384 W/DC
Inrush current	30 A/<3 s
Switching voltage	250 V AC1/24 V DC
Min. breaking capacity DC	500 mW
Output indication	red LED
Mechanical life	3x10 ⁷
Electrical life	0,7x10 ⁵
Controlling	
Voltage	230 V AC
Consumption of input	0,8-530 mVA
Load between S-A2	yes
Glow-lamps	yes, max. 4 pcs (at 1 ms)
Terminals	A1-S
Impulse length	min. 25 ms/ max. unlimited
Reset time	150 ms
Operating temperature	-20...+55 °C
Storage temperature	-30...+70 °C
Electrical strength	4 kV (supply - output)
Operating position	any
Mounting	DIN rail EN 60715
Protection degree	IP 40 from frontal panel
Connection cable length for sensor	max. 50 m (standard wire)
Overvoltage category	III
Pollution degree	2
Max. cable size	2,5 mm ²
Dimensions	90x17, 6x64 mm
Standards	EN 60255-6, EN 61010-1

Connection

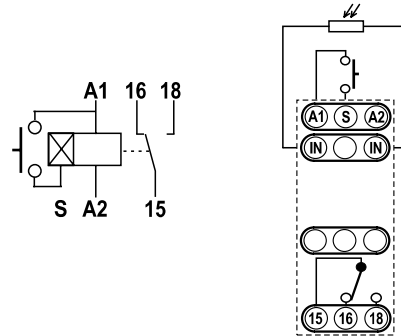

Function

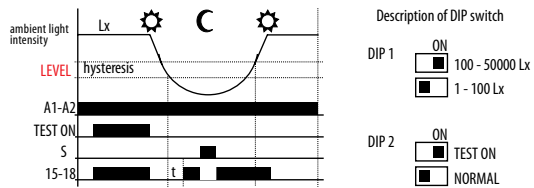

Dimensions

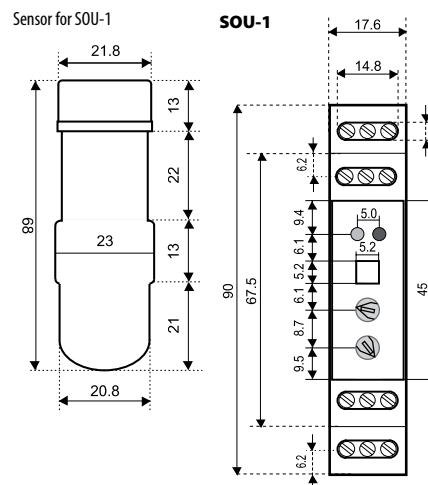

Description

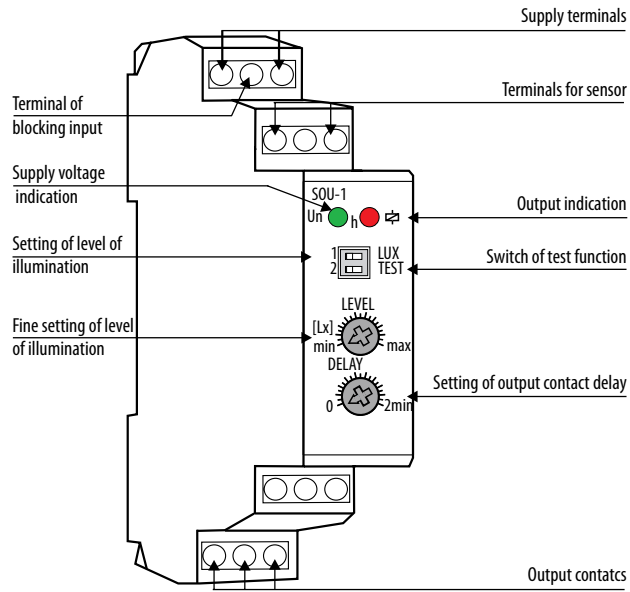

1-module design

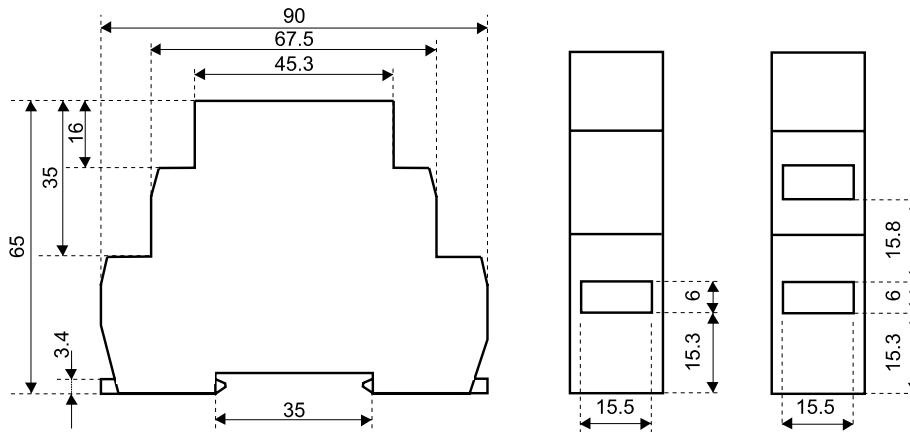

Twilight switch with digital time switch SOU-2 + sensor

EVE - ETIREL

Technical data	
	SOU-2
Supply	A1-A2
Supply voltage	230 V AC (50-60Hz)
Consumption	max. 3,5 VA
Supply voltage tolerance	-15% ; +10%
Back-up supply	yes
Summer/winter time	automatic
Output	
Number of contacts	1 changeover (AgNi)
Rated current	8 A / AC1
Breaking capacity	2500 VA / AC1, 240W / DC
Switching voltage	max. 250 V AC1 / 24 V DC
Min. breaking capacity DC	500 mW
Mechanical life	1x10 ⁷
Electrical life	1x10 ⁵
Time circuit	
Back-up supply	3 years
Accuracy	max. +/- 1s. day (23°C)
Minimal interval	1 min.
Data stored for	min. 10 years
Program circuit	
Illumination range	1-50000 Lx
Program place number	100
Program	daily, weekly
Data readout	LCD display
Controlling	
Operating temperature	-20...+55 °C
Storage temperature	-30...+70 °C
Electrical strength	4kV (supply - output)
Operating position	any
Mounting	DIN rail EN 60715
Protection degree	IP 20 from front panel
Overvoltage category	III.
Pollution degree	2
Max. cable size	2.5 mm ²
Dimensions	90 x 35,6 x 64 mm
Standards	EN 61812-1, EN 61010-1, EN 60255-6

Connection

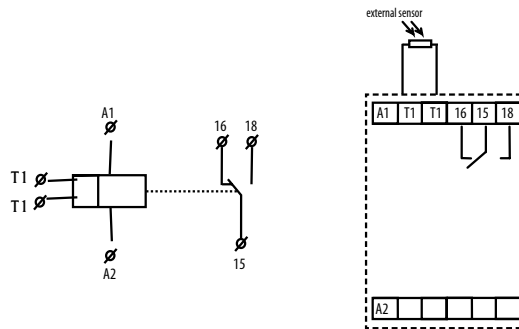

Controlling elements

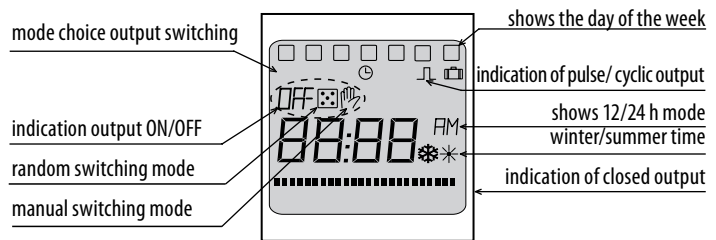

Description

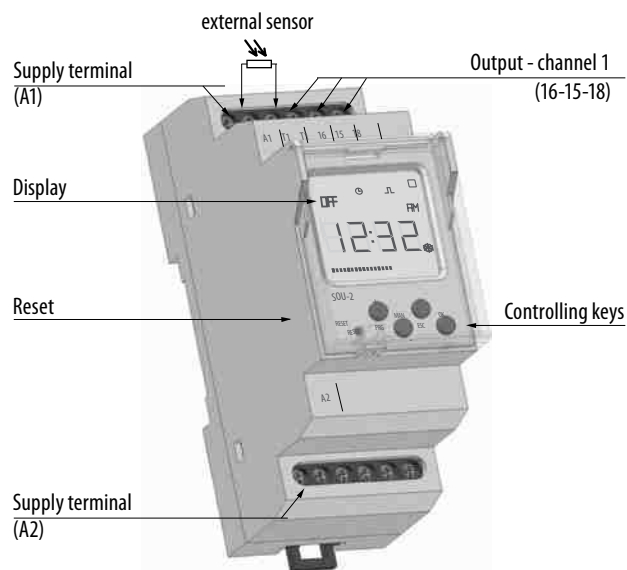

Technical data

Time switch ASTROCLOCK-2

Technical data

Rated voltage As indicated in the device	230V~ /50-60Hz
Tolerance	± 10%
No. of output contacts	2
Rated current/switching voltage	2x 16A / 250 V~
Maximum recommended loads (N.A)	See Electrical scheme and parameters
Consumption	16 VA (1,3 W)
Display	back-lit liquid crystal display
Accuracy	± 1 s / day at 23 °C
Temperature effect on accuracy	± 0.15 s / °C / 24 h
Power reserve	4 years (without connection to mains), 48 h (without battery and without connection to mains)
Software class and structure	Class A
Memory spaces	40
Types of manoeuvres	SUNRISE, SUNSET, FIXED TIME: ON/OFF, REDUC.
Astronomical adjustment	Daily
Operating temperature	-10 °C ... +45 °C
Transport and storage temperature	-20 °C ... +60 °C
Pollution degree	2
Protection level	IP 20 (EN60529)
Overvoltage category	Class II under correct mounting conditions
Transient impulse voltage	2.5 kV
Keyboard access cover	Sealable
Connection	With screw terminal for section conductors of 4mm ² maximum section
Battery	CR2032 - 3 V - 220 mAh
Size	2 DIN modules (35 mm)

Electrical scheme and parameters

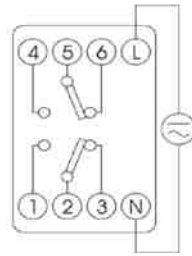

Incandescent 3000 W	Fluorescent 1200 VA	Low voltage halogen (12 V AC) 2000 VA	Halogen (230 V AC) 3000 W
Low consumption lamps 600 VA	Downlights 400 VA	LED 90 VA	

Dimensions

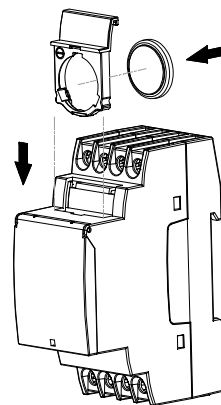
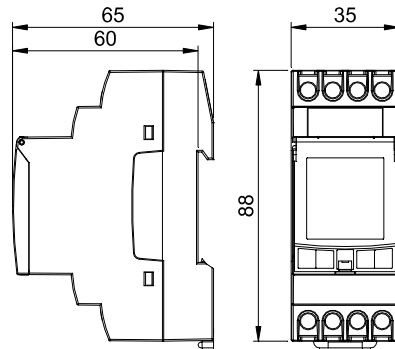

Digital time switch ETICLOCK-R1

Technical data	
	ETICLOCK-R1
Rated voltage and frequency As indicated on the device	(230 V ~ 50-60Hz)
Breaking capacity	μ 1x16 (10) A / 250 V AC
Own consumption	16 VA (1.3 W) max
Contact	AgSnO2 switched
Display screen	LCD
Running accuracy	\pm 1 s / day at 23 °C
Accuracy variation with temperature	\pm 0.15 s / °C / 24 h
Power reserve	4 years (with battery and no network connection)
	48 h (no battery and no network connection)
Memory spaces	40
No. of channels	1
Types of operations	ON/OFF, PULSE (1 ... 59 sec.) & CYCLES (1 ... 59 sec. / 1 min ... 23h, 59 min)
Operating temperature	-10 °C ... +45 °C
Transport and storage temperature	-20 °C ... +60 °C
Pollution degree	2
Protection level	IP 20 (EN60529)
Protection class	II under correct mounting conditions
Transient impulse voltage	2.5 kV
Temperature for the ball test	+ 80 °C (21.2.5)
Keyboard access cover	Sealable
Connection	With screw terminal for wire cross section of up to 4mm ²
Battery	CR2032 - 3 V - 220 mAh
Size	2x DIN mod. (35 mm)

Connection

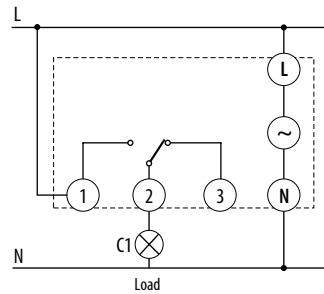

Controlling elements

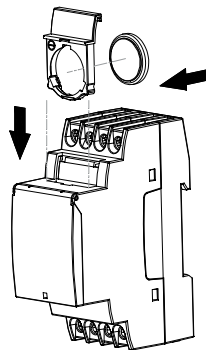
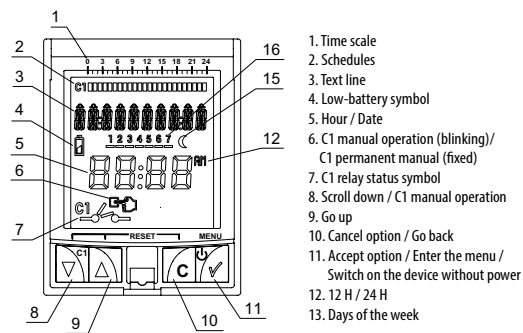

Dimensions

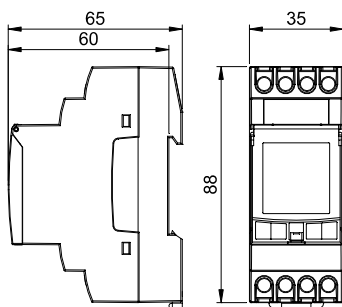

Maximum recommended loads

Load	Designation	Max. load
Incandescent		3000 W
Fluorescent		1200 VA
Low voltage halogen (12 V)		2000 VA
Halogen (230 V)		3000 W
Low consumption lamps		600 VA
Downlights		400 VA
LED		90 VA

Technical data

Digital time relay EDIGI-R2

Technical data		EDIGI-R2
Supply voltage		230 V c.a. +/- 10%
Frequency		50 Hz
Protection rating		IP20
Output type		
Potential-free changeover contact relay	N.O. contact	16(10)A / 250V~
	Zero Crossing	
	N.C. contact	16(2)A / 250V~
Type of action, disconnection and unit		1 B S U / electronic
Section of the cables to the terminals		1...6mm ²
Replaceable backup battery		3V lithium code CR2032
Power reserve in case of power failure		about 6 years from the first start-up, guaranteed by the lithium battery (replaceable)
Rated impulse voltage		4kV
Software class		A
Operating accuracy		+/- 1 sec/day at 25 °C
Consumption/Stand-by consumption		8 VA mono-channel / 6 VA dual-channel
Type of insulation		II
Rate of pollution		normal
Installation		DIN bar - back panel (with optional kit)
Operating temperature		-20 °C ... +55 °C
Storage temperature		-30 °C ... +60 °C
CE marking regulation		LVD/EMC EN60730-2-7
Languages available in the device		ENG,DE, HRV/SRP/BOS

Dimensions

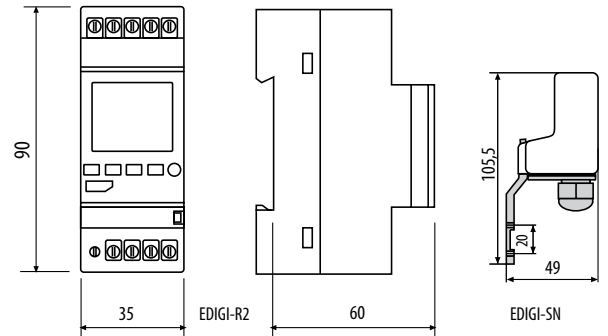

Controlling elements

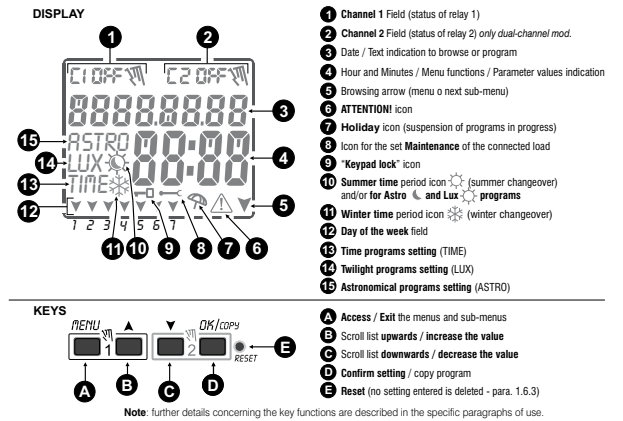

Connection

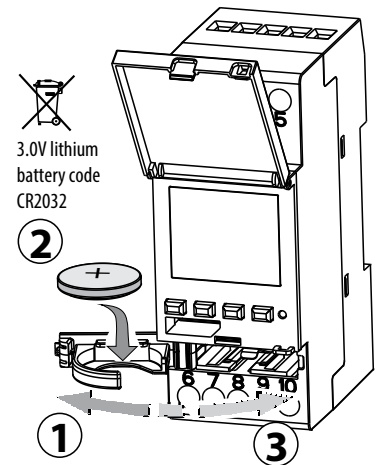
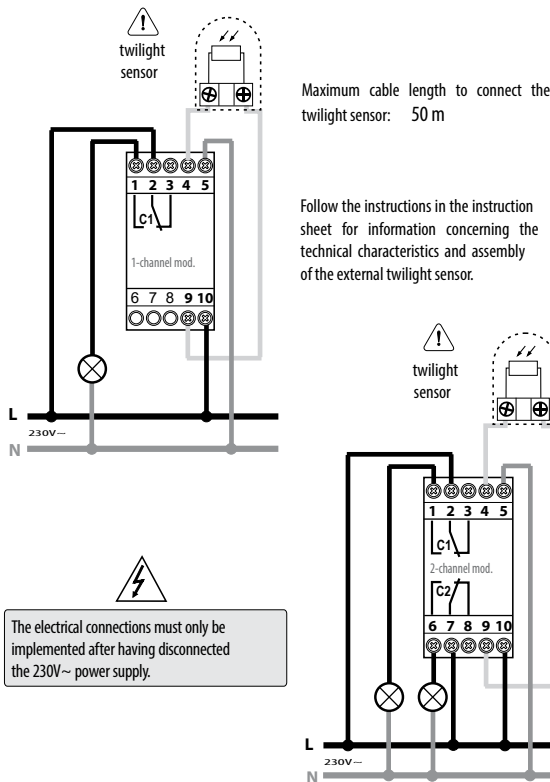

Maximum recommended loads

Load	Designation	Max. load
Incandescent		3000 W
Fluorescent		1100 W
Halogen (230 V)		3000 W
Low consumption lamps		7W ÷ 23W (max. 23 lamp.)

LED lighting: max inrush current 80A/20ms

Current monitoring relay PRI-51

Technical data	
PRI-51	
Supply circuit	
Supply	A1-A2
Universal supply	24-240V AC / 24 V DC (50-60 Hz AC)
Consumption	max 1,5 VA
Supply voltage tolerance	-15% - +10%
Measuring circuit	
Load	between B1 - B2
Current ranges	PRI51/1 PRI51/2 PRI51/5 PRI51/8 PRI51/16
	AC 0.1-1 A AC 0.2-2 A AC 0.5-5 A AC 0.8-8 A AC 1.6-16A
Inrush overload <1ms	100 A
Max. permanent current	1A 2A 5A 8A 16A
Time setting	potentiometer
Time ranges	0.5 s-10 s.
Setting accuracy - mechanical	5%
Time deviation	< 1 %
Limit values tolerance	5%
Temperature coefficient	< 0.1 % / °C
Hysteresis	5%
Output	
Number of contacts	1 x changeover (AgNi)
Rated current	8 A / AC1
Breaking capacity	2500 VA / AC1, 240W / DC
Output indication	green / red LED
Controlling	
Operating temperature	-20...+55 °C
Storage temperature	-30...+70 °C
Electrical strength	4 kV (supply-output)
Operating position	any
Mounting	DIN rail EN 60715
Protection degree	IP 40 from front panel
Overtoltage category	III.
Pollution degree	2
Max. cable size	2.5 mm ²
Dimensions	90 x 17,6 x 64 mm
Standards	EN 60255-6, EN 61010-1

Functions

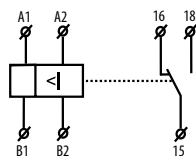
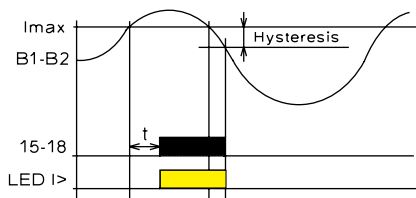

Connection

Example connection: PRI-51 with current transformer for current range increase

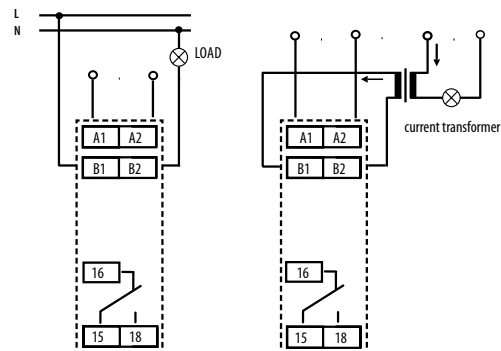

Voltage monitoring relay HRN-33, HRN-34, HRN-35

Technical data

	HRN-33, HRN-34, HRN-35		
Type	HRN-33	HRN-34	HRN-35
Supply	A1-A2	A1-A2	A1-A2
Universal supply	monitoring voltage range	monitoring voltage range	monitoring voltage range
Consumption	max. 1,2 VA AC / DC	max. 1,2 VA AC / DC	max. 1,2 VA AC / DC
Upper level U _{max}	160-276 V AC	18-30 V DC	160-276 V AC
Bottom level U _{min}	30-99% U _{max}	30-99% U _{max}	30-99% U _{max}
Time delay	0-10 s.	0-10 s.	0-10 s.
Setting accuracy (mechanical)	5 %	5 %	5 %
Repeat accuracy	< 1 %	< 1 %	< 1 %
Temperature coefficient	< 0,1% / °C	< 0,1% / °C	< 0,1% / °C
Hysteresis	2-6 % of adjusted value	2-6 % of adjusted value	2-6 % of adjusted value
Output			
Number of contacts	1 x changeover (AgNi)	1 x changeover (AgNi)	1 x changeover (AgNi) for each voltage level
Rated current	16 A / AC1	16 A / AC1	16 A / AC1
Breaking capacity	4000VA / AC1, 384W / DC	4000VA / AC1, 384W / DC	4000VA / AC1, 384W / DC
Inrush current	30 / < 3s.	30 / < 3s.	30 / < 3s.
Switching voltage	max. 250 V AC1 / 24V DC	max. 250 V AC1 / 24V DC	max. 250 V AC1 / 24V DC
Min. breaking capacity DC	500mW	500mW	500mW
Output indication	green / red LED	green / red LED	green / red LED
Mechanical life	3x10 ⁷	3x10 ⁷	3x10 ⁷
Electrical life	0.7x10 ⁵	0.7x10 ⁵	0.7x10 ⁵
Controlling			
Operating temperature	-20...+55 °C		
Storage temperature	-30...+70 °C		
Electrical strength	4 kV		
Operating position	any		
Mounting	DIN rail EN 60715		
Protection degree	IP 40 from front panel		
Overvoltage category	III.		
Pollution degree	2		
Max. cable size	2.5 mm ²		
Dimensions	90 x 17,6 x 64 mm		
Standards	EN 60255-6, EN 61010-1		

Symbols

HRN-33

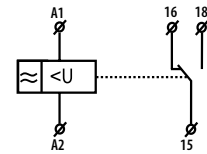

HRN-34

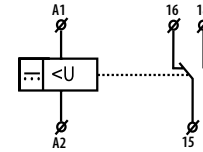

HRN-35

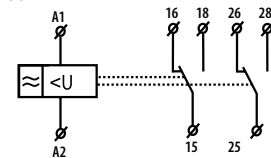

Functions

Legend:

- U_{max} - upper adjustable level of voltage
- U_n - measured voltage
- U_{min} - bottom adjustable level of voltage
- 15-18 - switching contact of output relay No.1
- 25-28 - switching contact of output relay No.2
- LED ≥ U_n - indication green
- LED U ≤ - indication red

HRN-33

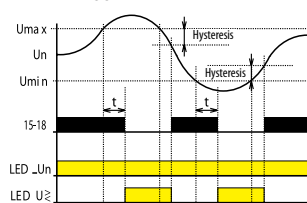

HRN-34

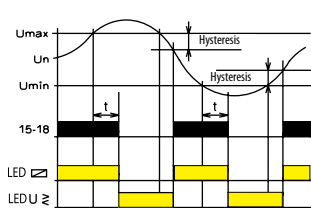

HRN-35

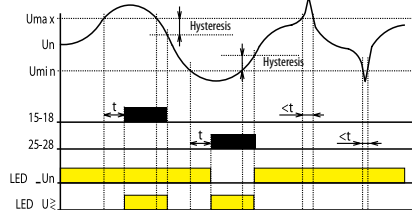

Connection

Un HRN-33



Un HRN-34

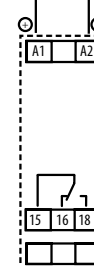

Un HRN-35

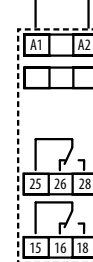

Technical data

Indication LED

HRN-33

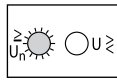

Normal state
 $U_{min} < U_n < U_{max}$
 Green LED = ON
 Red LED = OFF

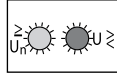

Exceeded U_{max} (overvoltage)
 Drop below U_{min} (undervoltage)
 $U_n > U_{max}$ or $U_n < U_{min}$.
 Green LED = ON
 Red LED = ON

HRN-34

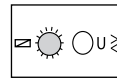

Normal state
 $U_{min} < U_n < U_{max}$
 Green LED = ON
 Red LED = OFF

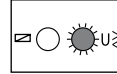

Exceeded U_{max} (overvoltage)
 Drop below U_{min} (undervoltage)
 $U_n > U_{max}$ or $U_n < U_{min}$.
 Green LED = OFF
 Red LED = ON

HRN-35

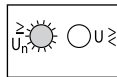

Normal state
 $U_{min} < U_n < U_{max}$
 Green LED = ON
 Red LED = OFF

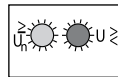

Exceeded U_{max} (overvoltage)
 $U_n > U_{max}$
 Green LED = ON
 Red LED = ON

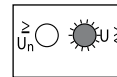

Drop below U_{min} (undervoltage)
 $U_n < U_{min}$
 Green LED = OFF
 Red LED = ON

Function description

Monitoring relay series HRN-3 monitors level of voltage in single-phase circuits. Monitored voltage serves also as supply voltage. It is possible to set two independent levels of voltage, when exceeded output is activated. HRN-33 and HRN-34 - in normal state the output relay is permanently switched on. It switches off when voltage is below or above deflection. This combination of linkage of the output relay is advantageous when the full failure of supply (monitored) voltage is considered to be a faulty state in the same way as a decrease of voltage within the set level. Output relay is in both situations always switched off. Differently HRN-35 version uses independent relay for each level, in normal state it is switched off. If the upper level is exceeded (for example overvoltage) 1st relay switches on, when the bottom level (e.g. undervoltage) is exceeded 2nd relay switches. It is thus possible to see the particular faulty state. To eliminate short peaks in the main, the time delay, which is possible to be set in range 0 - 10 s, is used. It functions when changing from normal to faulty state and prevents unavailing pulsation of the output relay caused by parasitive peaks. Time delay doesn't apply when changing from faulty to normal state, but hysteresis (1-6% depends on the voltage setting) apply. Thanks to changeover contacts it is possible to get other configurations and functions according to actual requirements of the application.

Description

HRN-33, HRN-34

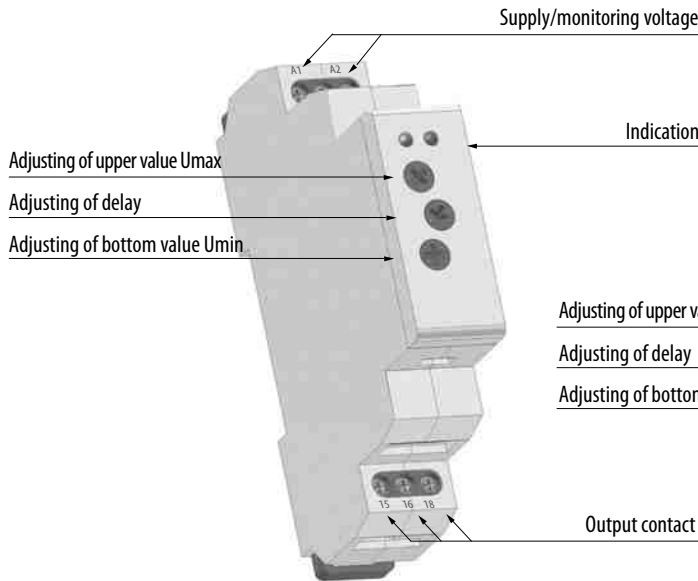

HRN-35

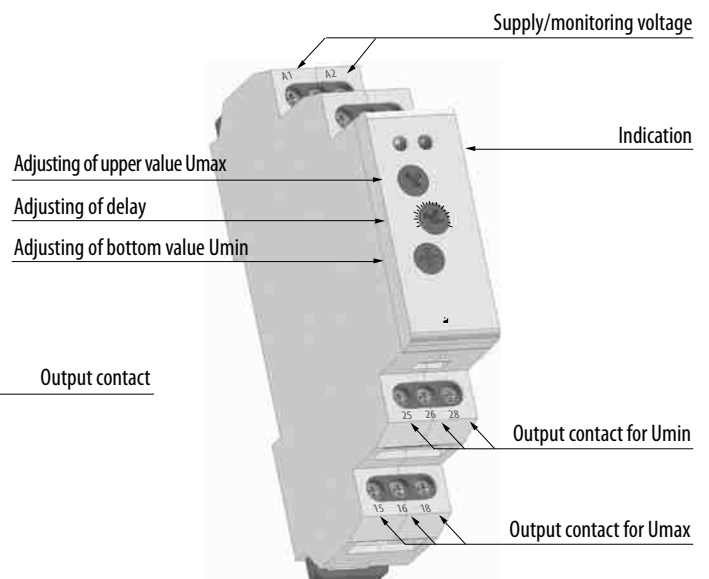

Over/undervoltage monitoring relay HRN-54, HRN-54N

Technical data

	HRN-54	HRN-54N
Supply and measuring	L1,L2,L3	L1,L2,L3,N
Supply	L1,L2,L3	L1,N
Supply/measured voltage	3 x 400 V	3 x 400 V/ 230 V
Level U_{min}	75 - 95% U_n	
Level U_{max}	105 - 125% U_n	
Consumption	max. 2 VA	
Hysteresis	5 %	
Max. permanent overload	3 x 460V AC	3 x 265V AC
Peak overvoltage <1ms.	3 x 500V AC	3 x 288V AC
Time delay T1	max. 500 ms.	
Time delay T2	0.1 - 10 s.	
Output		
Number of contacts	1 x changeover (AgNi)	
Rated current	8 A / AC1	
Breaking capacity	2500 VA / AC1, 240W / DC	
Inrush current	10 A	
Switching voltage	max. 250 V AC1 / 24 V DC	
Min. breaking capacity DC	500mW	
Output indication	red LED	
Mechanical life	1×10^7	
Electrical life	1×10^5	
Reset time	max. 150 ms.	
Controlling		
Operating temperature	-20...+55 °C	
Storage temperature	-30...+70 °C	
Electrical strength	4 kV	
Operating position	any	
Mounting	DIN rail EN 60715	
Protection degree	IP 40 from front panel	
Overvoltage category	III.	
Pollution degree	2	
Max. cable size	2.5 mm ²	
Dimensions	90 x 17,6 x 64 mm	
Standards	EN 60255-6, EN 61010-1	

Connection

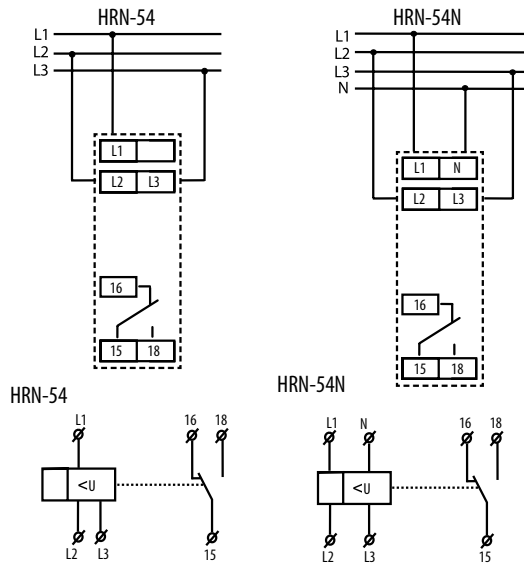

Functions

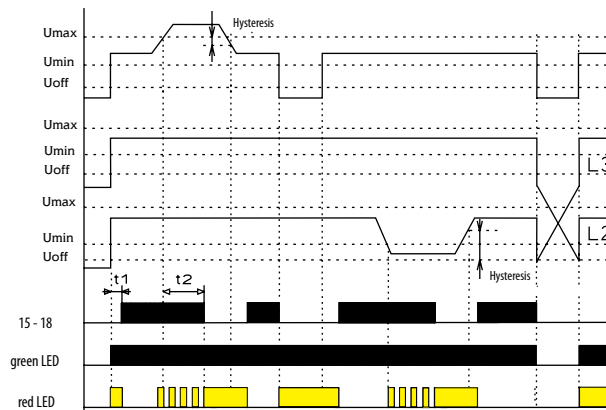

Function description

Relay in 3-phase main monitors size of phase voltage. It is possible to set two independent voltage levels and thus it is possible to set two independent voltage levels and monitor e.g. undervoltage and overvoltage independent. In normal state when voltage is within set levels, output relay is closed and red LED shines. In case voltage exceeds or falls below the set levels, output relay breaks and red LED shines (LED indicates faulty state – flashes when timing). In case of In case supply voltage falls below 60 % U_n (U_{off} lower level) relay immediately breaks without delay and faulty state is indicated by red LED. In case timing is in progress and faulty state is indicated, timing is immediately stopped.

Description

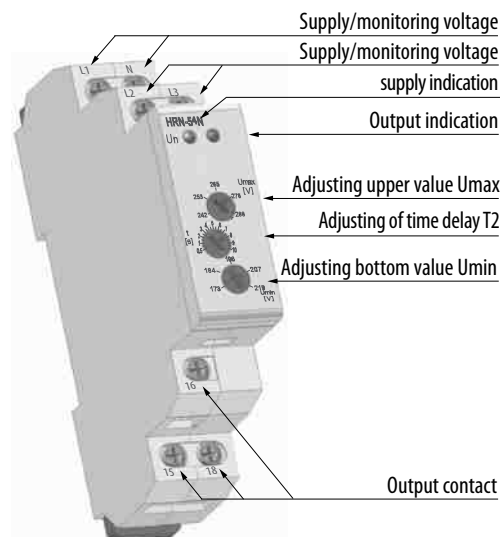

Technical data

Level switch HRH-5

Technical data	
	HRH-5
Functions:	2
Supply terminals:	A1 - A2
Supply voltage:	24... 240 V AC/ DC
Input:	max. 2 VA
Tolerance of supply voltage:	-15 %; +10 %
Measuring circuit	
Sensitivity (input resistance):	adjustable in range 5 kΩ -100 kΩ
Voltage in electrodes:	max. 3.5 V AC
Current in probes:	<0.1 mA AC
Time response:	max. 400 ms
Max. capacity of probe cable:	max. 400 ms
Time delay (t):	800 nF (sensitivity 5kΩ), 100 nF (sensitivity 100 kΩ)
Time delay after switching on (t1):	adjustable, 0.5 -10 sec
Accuracy	1.5 sec
Accuracy in setting (mechanical):	± 5 %
Output	
Number of contacts:	1x changeover (AgNi)
Rated current:	8 A / AC1
Switched output:	2500 VA, 240 W
Switched voltage:	250 V AC1 / 24 V DC
Min. switched output DC:	500 mW
Mechanical life (AC1):	1x10 ⁷
Electrical life:	1x10 ⁵
Other data	
Operational temperature:	-20.. +55 °C
Storing temperature:	-30.. +70 °C
Electrical strength:	3.75 kV (supply - sensors)
Operational position:	any
Mounting:	DIN rail EN 60715
Protection degree:	IP 40 from front panel
Overvoltage category:	III.
Pollution degree:	2
Profile of connecting wires (mm ²)	max.1x 4, max.2x2.5/ with sleeve max. 1x2.5, 2x1.5
Dimensions:	90 x 17.6 x 64 mm
Weight:	72 g
Applicable standards:	EN 60255-6, EN 61010-1

Symbol

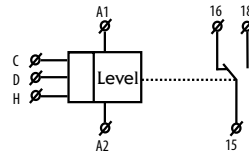

Description

Indication of supply voltage
Choice of function

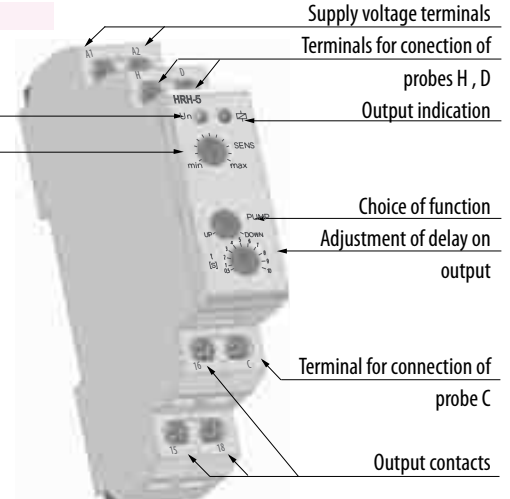

HRH-5

Connection

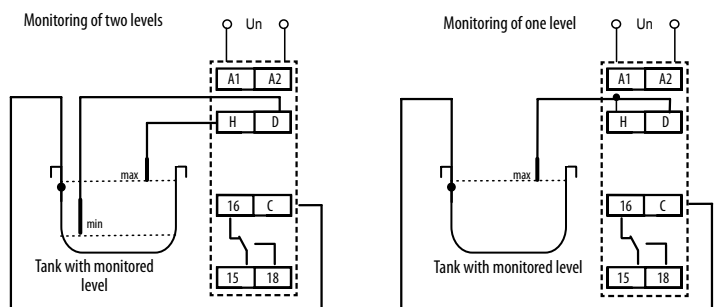

Functions

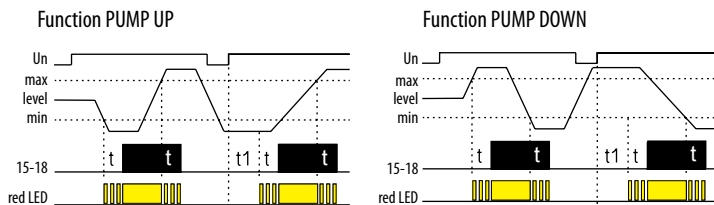

Relay is designated for monitoring of levels of conductive liquids with possibility of functions: PUMP UP or PUMP DOWN. To prevent polarization and liquid electrolysis of liquid, and undesirable oxidation of measuring probes, alternating current is used. For measuring use three measuring probes: H- upper level, D- lower level, C - common probe. In case you use a tank made of a conductive material, you can use it as probe C. In case you require monitoring of one level only, it is necessary to connect inputs H and D and connect them to one probe - in this case sensitivity is lowered by half (2.5... 50kΩ). Probe C can be connected with a protective wire of supply system (PE). To prevent undesirable switching out output contacts by various influences (sediment on probes, humidity...) it is possible to set sensitivity of the device according to conductivity of monitored liquid (corresponding to "resistance" of liquid) range 5 up to 100...kΩ. To reduce influences of undesirable switching of output contacts by liquid gorgle in tanks, it is possible to set delay of output reaction 0,5 - 10s.

Technical data - Measuring probes HRH

HRH-5-measuring probes	
Cables	10m, 15m, 20m, 30m, 40m
Max. cable size	1,5 mm ²
Insulation voltage Ui	750 V
Fluids	Conductible, unaggressive*

* Special probes for aggressive fluids

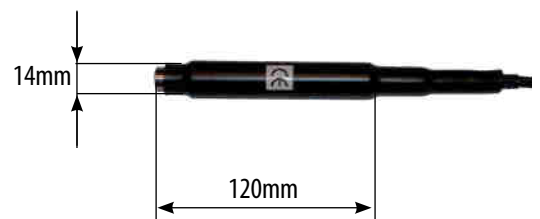

Level switch HRH-8

Technical data		HRH-8
Function		8
Supply terminals		A1-A2
Voltage range		AC 230 V, AC 110 V, AC 400 V, AC/DC 24 V (AC 50 - 60 Hz)
Max load		2,5 W / 5 VA (AC 230 V, AC 110V, AC 400 V), 1,4 W / 2 VA (AC/DC 24 V)
Supply voltage tolerance		-15 %; +10 %
Measuring circuit		
Hysteresis (input - opening)		5 kΩ - 100 kΩ
Voltage on electrode		max. AC 3,5 V
Current in probes		AC < 1 mA
Time reaction		max. 400 ms
Max. cable capacity		800 nF (sensitivity 5kΩ), 100 nF (sensitivity 100 kΩ)
Time delay t		0,5 -10 s
Accuracy		
Setting accuracy (mech.):		± 5 %
Output		
Number of contacts		2x changeover / SPDT (AgNi / Silver Alloy)
Current rating		16 A / AC1
Breaking capacity		4000 VA / AC1, 384 W / DC
Inrush current		30 A / < 3 s
Switching voltage		250 V AC1 / 24 V DC
Output indication		red LED
Mechanical life		3x10 ⁷
Electrical life (AC1)		0,7x10 ⁵
Other information		
Operating temperature		-20 ... +55 °C
Storage temperature		-30 ... +70 °C
Electrical strength		4 kV (supply - output)
Operating position		any
Mounting		DIN rail EN 60715
Protection degree		IP40 from front panel / IP20 terminals
Overvoltage category		III
Pollution degree		2
Max. cable size (mm ²)	solid wire	max. 1x 2,5 or 2x1,5
	with cavern	1x 1,5 (AWG 12)
Dimensions		90 x 52 x 65 mm
Standards		EN 60255-6, EN 61010-1

Technical data

Description

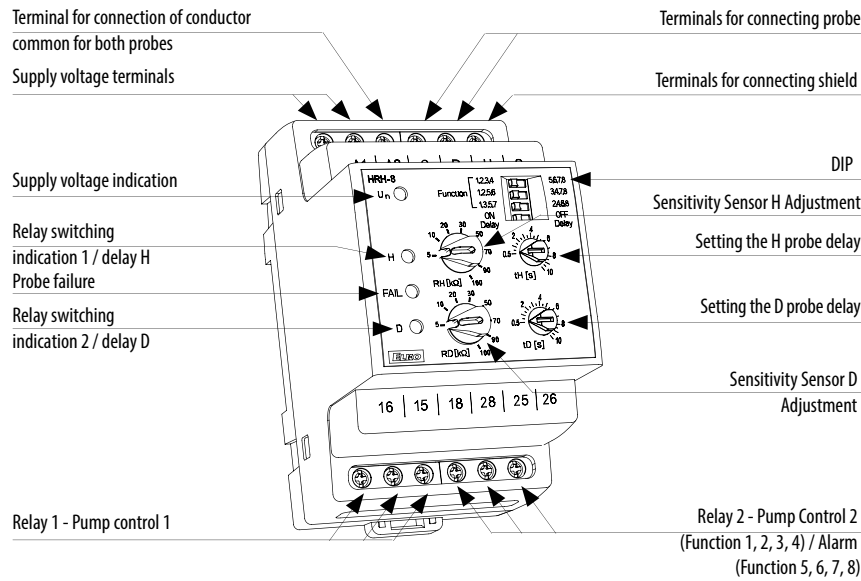

Description and importance of DIP switches

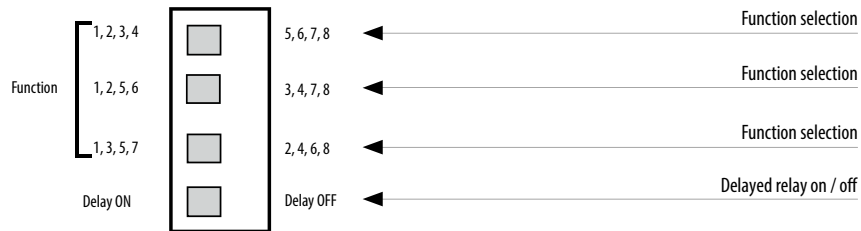

Connection

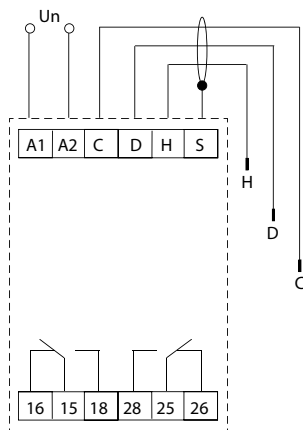

Symbol

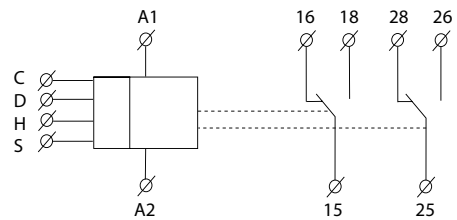

Measuring probes

There can be any measuring probe (any conductive contact, it is recommended to use brass or stainless steel).
 The probe wire does not need to be shielded, but it is recommended.
 When using a shielded wire, the shielding is connected to terminal S.

Functions

PUMP UP, ON DELAY (Function 1,3,4)

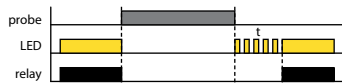

PUMP DOWN, ON DELAY (Function 2,3,4)

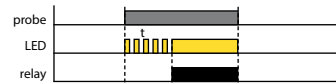

PUMP UP, OFF DELAY (Function 1,3,4)

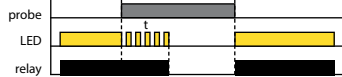

PUMP DOWN, OFF DELAY (Function 2,3,4)



PUMP UP, OFF DELAY (Function 5)

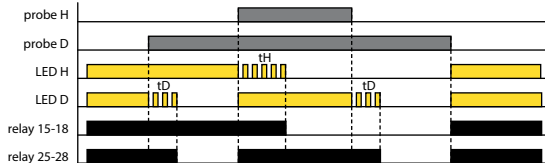

PUMP UP, ON DELAY (Function 5)

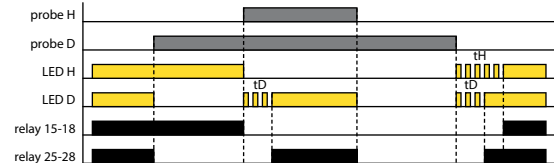

PUMP DOWN, OFF DELAY (Function 6)

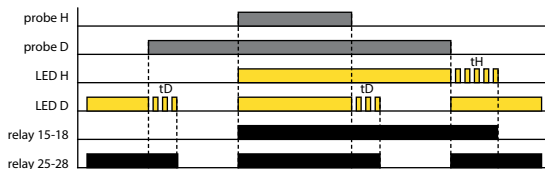

PUMP DOWN, ON DELAY (Function 6)

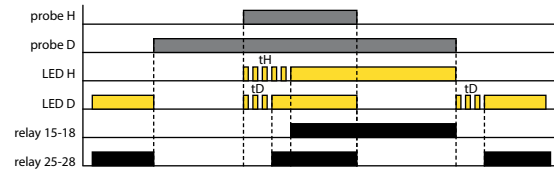

WELL - TANK, OFF DELAY (Function 7)

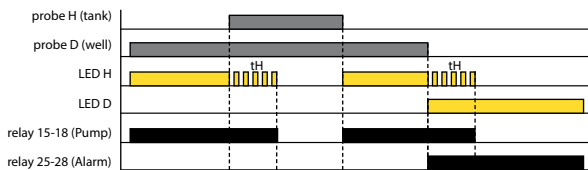

WELL - TANK, ON DELAY (Function 7)

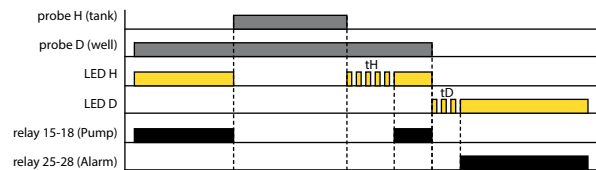

RESERVOIRS - TANK, OFF DELAY (Function 8)

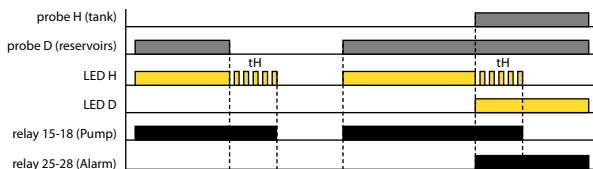

RESERVOIRS - TANK, ON DELAY (Function 8)

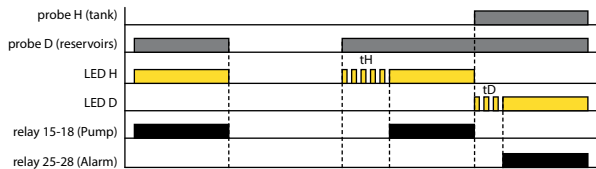

Function description

The relay is designed to monitor the level of conductive liquids with a choice of 8 functions:

- 1) - 2 separate tanks (each with 1 probe) - both PUMP UP (filling)
- 2) - 2 separate tanks (each with 1 probe) - both PUMP DOWN (emptying)
- 3) - 2 separate tanks (each with 1 probe) - H PUMP DOWN probe, D PUMP UP probe
- 4) - 2 separate tanks (each with 1 probe) - H PUMP UP probe, probe D PUMP DOWN
- 5) - both probes in one tank - PUMP UP - maintain level between probes H and D (as HRH-S), relay 1 switches on the pump, relay 2 alarm (level is not between probes H and D)
- 6) - Both probes in one tank - PUMP DOWN - maintaining the level between probes H and D (as HRH-S), relay 1 switches on the pump, relay 2 alarm (the level is not between probes H and D)
- 7) - Pumping from the well to the tank - probe D in the well, probe H in the tank. The pump only runs if the probe D is flooded (enough water in the well) and the tank is not full (probe H). The alarm reports a lack of water in the well (probe D is not flooded).
- 8) - Pumping from the sump to the tank - probe D in the sump, probe H in the tank. The pump only runs if the probe D is flooded (full tank) and

the tank is not full (probe H). The alarm reports the status of full tank and sump (both probes are flooded).

LED indication:

The red LED lights up - the corresponding relay is switched on

Red LED flashes - delay timing

The yellow LED indicates probe failure - Functions 5, 6 probe H is flooded and probe D is not. At the same time both red LEDs flash.

To prevent polarization and electrolysis of the liquid and undesirable oxidation of the monitoring probes, an AC current of 10 Hz is used for monitoring.

The low frequency has a positive effect on suppression of interference by 50 (60) Hz. Three probes are used to monitor the level: H - upper level, D - lower level and C - common probe. In the case of the use of a conductive material tank, it is possible to use the tank itself as a C probe. Probe C can also be connected to the protective conductor of the power supply system (PE). To prevent undesired switching by various influences (soiling of dips, moisture ...), the sensitivity of the device can be set according to the conductivity of the liquid being monitored (corresponding to the "resistance" of the liquid) in the range of 5 to 100 kΩ. To limit the effect of undesired switching of output contacts by raising the liquid level in the tank, it is possible to set the output response delay 0,5 - 10 s.

Technical data

Thermostat relay TER-3 (A, B, C)

Technical data	
	TER-3 (A, B, C)
Function	single level
Supply	A1-A2
Universal supply	AC/DC 24-240 galvanically unseparated
Consumption	2 VA
Supply voltage tolerance	-15% - +10%
Measuring circuit	
Measuring terminals	T1 - T1
Temperature range	TER-3A TER-3B TER-3C -30..+10 °C 0..+40 °C -30..+70 °C
Hysteresis	adjustable in range 0.5...5K
Sensor	external, termistor NTC
Sensor fault indication	flashing red LED
Setting accuracy - mechanical	5%
Switching difference	0,5°C
Temperature coefficient	< 0.1 % / °C
Output	
Number of contacts	1 x changeover (AgNi)
Rated current	16 A / AC1, 10A/24 V DC
Breaking capacity	4000 VA / AC1, 300W / DC
Switching voltage	250V AC1/ 24V DC
Min. breaking capacity DC	500 mW
Output indication	red LED
Mechanical life	3x10 ⁷
Electrical life	0,7x10 ⁵
Controlling	
Operating temperature	-20...+55 °C
Storage temperature	-30...+70 °C
Electrical strength	4 kV
Operating position	any
Mounting	DIN rail EN 60715
Protection degree	IP 40 from front panel
Overvoltage category	III.
Pollution degree	2
Max. cable size	2,5 mm ²
Dimensions	90 x 17,6 x 64 mm
Standards	EN 60730-2-9, EN 61010-1

Connection

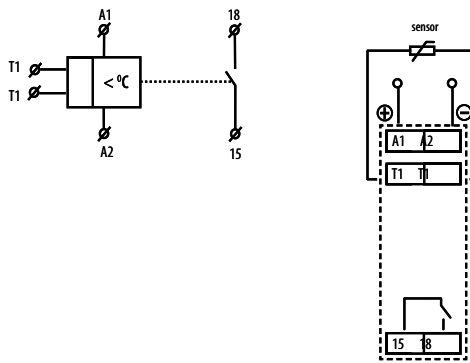

Functions

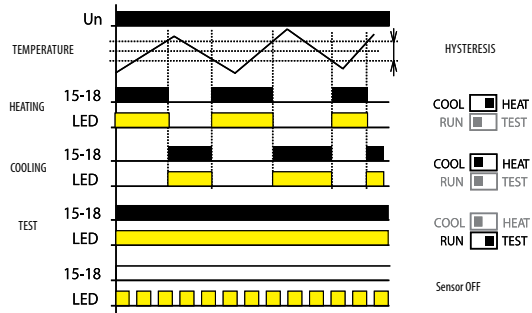

TER-3 It is a single but practical thermostat with a separated sensor for monitoring temperature. The device is placed in a switchboard and an external sensor senses temperature of required space, object or liquid. Supply is not galvanically separated from the sensor. The sensor is double insulated. Maximal length of a delivered sensor is 12m. device has in-built indication of sensor damage, which means that in case of short-circuit or disconnection red LED flashes. Thanks to adjustable hysteresis, it is advantageous to regulate width of the range and thus define sensitivity of load switching. Sensed temperature is decreased by set hysteresis. When installing it is necessary to keep in mind that hysteresis is increased by temperature gradient between sensor's jacket and thermistor.

Description

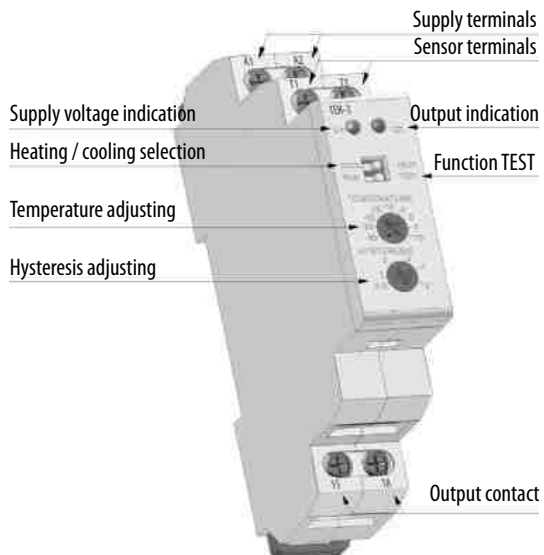

Thermostat for monitoring temperature of motor winding TER-7

Technical data

	TER-7
Function	monitoring temperature of motor winding
Supply terminals	A1-A2
Supply voltage	24 - 240 V AC/DC
Consumption	max. 2 VA
Supply voltage tolerance	-15%; +10%
Measuring circuit	
Measuring terminals	Ta-Tb
Cold sensor resistance	50 Ω - 1.5 kΩ
Upper level	3.3 kΩ
Bottom level:	1.8 kΩ
Sensor:	PTC temperature of motor winding
Sensor failure indication	blinking red LED
Accuracy	< 5%
Accuracy in repetition	± 5%
Temperature dependance	< 0.1% / °C
Output	
Number of contacts	2x changeover (AgNi)
Rated current	8 A / AC1
Breaking capacity	2000 VA / AC1, 192 W / DC
Inrush current	10 A / < 3 s
Switching voltage	250 V AC1 / 24 V DC
Min. breaking capacity DC	500mW
Mechanical life	3x10 ⁷
Electrical life	0.7x10 ⁵
Other information	
Operating temperature	-20 .. +55 °C
Storage temperature	-30 .. +70 °C
Electrical strength	4 kV (supply - output)
Operating position	any
Mounting	DIN rail EN 60715
Protection degree	IP 40
Overvoltage category	III.
Pollution degree	2
Max. cable size (mm ²)	solid wire max. 1x 2.5 or 2x1.5 with sleeve max. 1x2.5
Dimensions	90 x 17.6 x 64 mm,
Weight	83 g
Standard	EN 60730-2-9, EN 61010-1

Note:
Sensors could be in series in abide with conditions in technical specification - switching limit.

Warning:
In case of supply from the main, neutral wire must be connected to terminal A2.

Symbol and connection

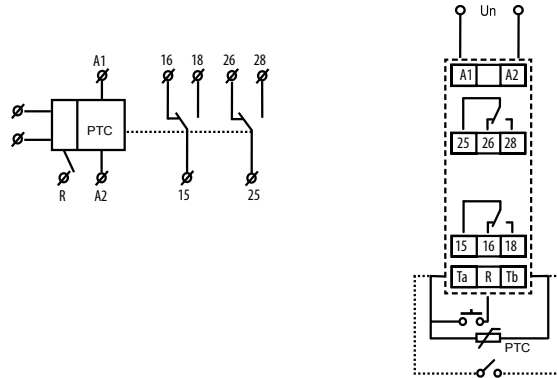

Function

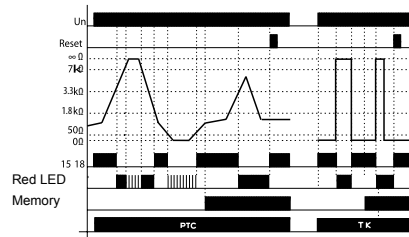

The device controls temperature of motor winding with PTC thermistor which is mostly placed in motor winding or very close to it. Resistance of PTC thermistor run to max 1.5 kΩ in cold stage. By temperature increase the resistance goes strongly up and by overrun the limit of 3.3 kΩ the contact of output relay switch off - mostly contactor controlling a motor. By temperature decrease and thereby decrease of thermistor resistance under 1.8 kΩ the output contact of relay again switches on. The relay has function "Control of sensor fault". This controls interruption or disconnection of sensor. When switch is in position "TK" monitoring of faulty sensor is not functional - it is possible to connect bimetal sensor with only 2 states: ON or OFF. The device can work with bi-metal sensor in this position. Other safety unit is function "Memory". By temperature overrun (and output switches off) the output is hold in faulty stage until service hit. This bring the relay to normal stage (with RESET button) on front panel or by external contact (remote).

Description

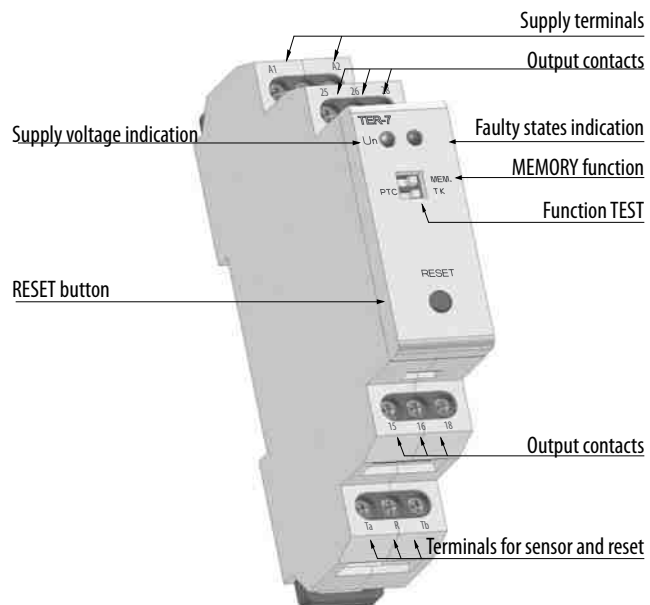

Technical data

Multifunction digital thermostat TER-9

Technical data	
	TER-9
Number of functions	6
Supply	A1-A2
Supply voltage	AC 230V or AC/DC 24V, galvanically separated
Consumption	max. 3,5 VA
Supply voltage tolerance	-15% - +10%
Measuring circuit	
Measuring terminals	T1 - T1 in T2-T2
Temperature range	-40...+110 °C
Hysteresis (sensitivity):)	adjustable in range 0.5...5K
Difference temperature	adjustable 1.. 20 °C
Sensor	termistor NTC 12Ω at 25°C
Sensor fault indication	sign "Err"
Measuring accuracy	5 %
Repeat accuracy	<0,5 %
Temperature coefficient	< 0.1 % / °C
Output	
Number of contacts	1 x changeover for each output (AgNi)
Rated current	8 A / AC1
Breaking capacity	2500 VA / AC1, 240W / DC
Switching voltage	250V AC1/ 24V DC
Min. breaking capacity DC	500 mW
Output indication	ON / OFF
Mechanical life	1x10 ⁷
Electrical life	1x10 ⁵
Controlling	
Operating temperature	-20...+55 °C
Storage temperature	-30...+70 °C
Electrical strength	4 kV (supply - contact)
Operating position	any
Mounting	DIN rail EN 60715
Protection degree	IP 40 from front panel
Overvoltage category	III.
Pollution degree	2
Max. cable size	2.5 mm ²
Dimensions	90 x 35,6 x 64 mm
Standards	EN 60730-2-9, EN 61010-1, EN 61812-1

Connection

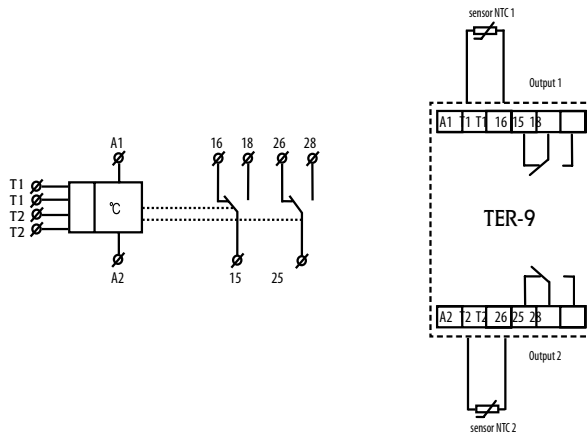

Note: It is possible to operate the device with one sensor. In such case it is necessary to connect resistor 10kΩ. This resistor is a part of delivery.

Description

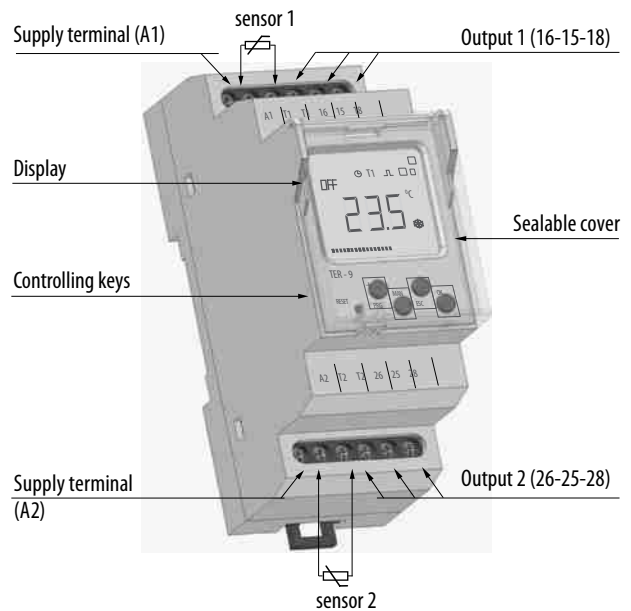

2 independent single-stage thermostat

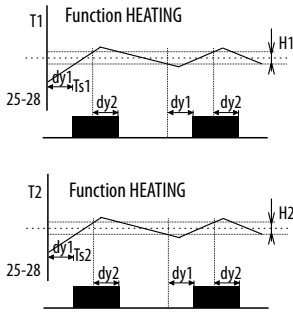

- Legend:**
 Ts1 - real (measured) temperature 1
 Ts2 - real (measured) temperature 2
 T1 - adjusted temperature T1
 T2 - adjusted temperature T2
 H1 - adjusted hysteresis for T1
 H2 - adjusted hysteresis for T2
 dy1 - set switching delay of the output
 dy2 - set delay on output breaking
 15-18 output contact (for T1)
 25-28 output contact (for T2)

Output contact switched until adjusted temperature is reached. Hysteresis eliminates frequent switching. Heating/cooling function adjusted in the menu.

Dependent functions of 2 thermostats

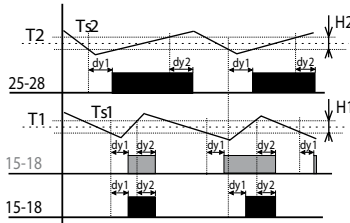

- Legend:**
 Ts1 - real (measured) temperature 1
 Ts2 - real (measured) temperature 2
 T1 - adjusted temperature T1
 T2 - adjusted temperature T2
 H1 - adjusted hysteresis for T1
 H2 - adjusted hysteresis for T2
 dy1 - set switching delay of the output
 dy2 - set delay on output breaking
 25-28 output contact (for T2)
 15-18 output contact (intersection T1 and T2)

Output 15-18 is closed, if temperature of both thermostats is below an adjusted level. When any thermostat reaches adjusted level, the contact 15-18 open. Serial inner connection of thermostats (logic function AND).

Differential thermostat

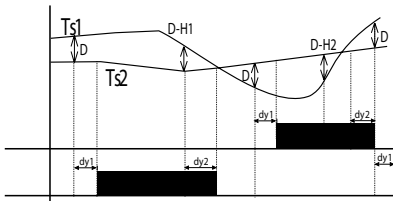

- Legend:**
 Ts1 - real (measured) temperature T1
 Ts2 - real (measured) temperature T2
 D - adjusted difference
 dy1 - set switching delay of the output
 dy2 - set delay on output breaking
 15-18 output contact (for T1)
 25-28 output contact (for T2)

Switching of output corresponds with input, which has lower temperature when difference is exceeded differential thermostat is used for keeping two identical temperature e.g. in heating systems (boiler and reservoir), solar systems (collector - reservoir, exchanger), water heating (water heater, water distribution) etc.

2-stage thermostat

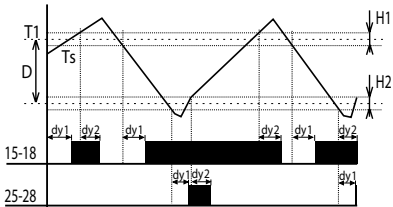

- Legend:**
 Ts - real (measured) temperature
 T1 - adjusted temperature
 D - adjusted difference
 H1 - adjusted hysteresis for T1
 H2 - adjusted hysteresis for T2
 dy1 - set switching delay of the output
 dy2 - set delay on output breaking
 15-18 output contact
 25-28 output contact

Typical example of use for two-stage thermostat is e.g. in boiler-room, where there are two boilers from which one is main and the other one is auxiliary. The main boiler is managed according to set temperature and auxiliary boiler is switched in case temperature falls under set difference. Thus it helps to the main boiler in case outside temperature dramatically falls. In the range of difference (D) output 15-18 functions as normal thermostat to input 1 (type 1). In case temperature falls under set difference, output 2 switches.

Thermostat with "WINDOW"

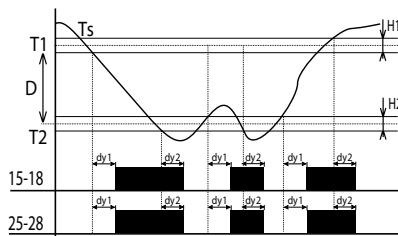

- Legend:**
 Ts - real (measured) temperature
 T1 - adjusted temperature MAX
 T2 - adjusted temperature MIN (T2=T1-D)
 H1 - adjusted hysteresis for T1
 H2 - adjusted hysteresis for T2
 dy1 - set switching delay of the output
 dy2 - set delay on output breaking
 15-18 output contact
 25-28 output contact

Output is closed (heating) only if temperature is within adjusted range. If temperature is out of range, the contact opens. T2 is set as T1-D. The function is used for protection of gutters against freezing.

Thermostat with dead zone

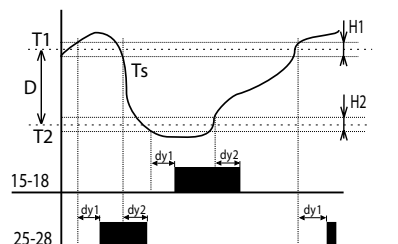

- Legend:**
 Ts - real (measured) temperature
 T1 - adjusted temperature T1
 T2 - adjusted temperature T2 (T2=T1-D)
 H1 - adjusted hysteresis for T1
 H2 - adjusted hysteresis for T2
 dy1 - set switching delay of the output
 dy2 - set delay on output breaking
 15-18 output contact (heating)
 25-28 output contact (cooling)

In case of thermostat with a "dead zone", it is possible to set temperature T1 and a difference (respectively a width of dead zone D). In case the temperature with set hysteresis H1 is lower than T1, the output contact switches heating ON and when T1 is reached it opens. In case the temperature falls under T2, contact switches cooling on and opens when T2 is reached. This function can be used for example for automatic air warming and cooling in ventilation so the site is always within the range T1 and T2.

Technical data

Thermal sensor TZ

Temperature sensors are made of thermistor NTC embedded in a metal sleeve by thermo-conductive sealer (TZ)

- Sensor TZ: - cable V03SS-F 2Dx0,5mm with silicon insulation
 - suitable mainly for use in extreme temperatures

Technical parameters TZ	
Range:	-40...+125°C
Scanning element:	NTC 12K 2%
In air/in water:	(t65) 62s/8s
In air/in water:	(t95) 216s/23s
Cable material:	silicone
Terminal material:	nickel-couted copper
Protection degree:	IP 67
Protection class:	II (double insulation)

Resistive values of sensors in dependance on temperature	
Temperature (°C)	Sensor NTC (kΩ)
20	14,7
30	9,8
40	6,6
50	4,6
60	3,2
70	2,3

TZ: Thermal sensors for range -40...+125°

TZ-0 - Thermo sensor can be connected directly to terminal block (length of the sensor 110mm)

TZ-3 - Temperature sensor 3m, double isolation silicone

TZ-6 - Temperature sensor 6m, double isolation silicone

TZ-12 - Temperature sensor 12m, double isolation silicone

Dimensions

1-module devices

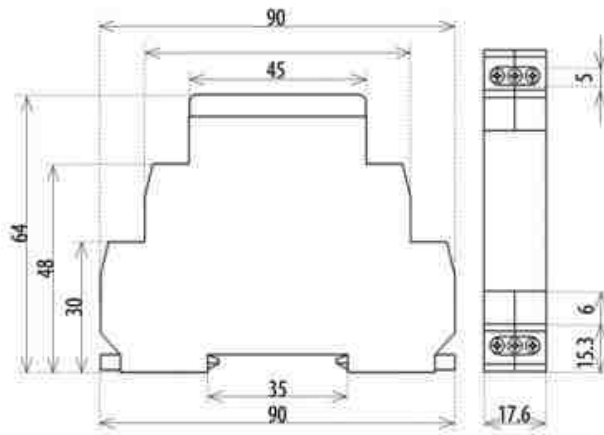



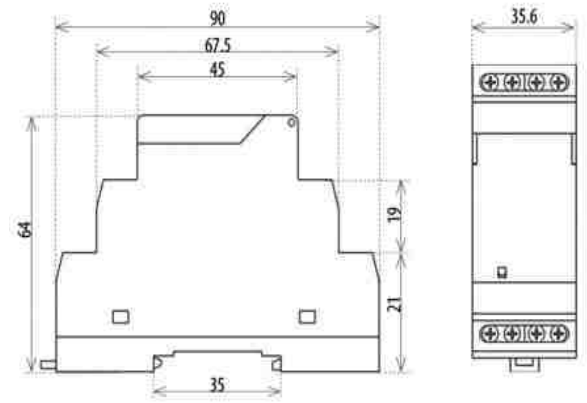

2-module devices







Product loadability





It is valid for following products: CRM-4, SHT-1, MR-41, MR-42, SOU-1, SHT-1/2, SHT-3, SHT-3/2, CRM-42, SMR-B

relay contact 16 A	Load								
						AC1	AC3	AC15	DC1 (24/110/220V)
AgSNO ₂	2000 W	1000 W	1000 W	750 W	500 W	4000 VA	0,9 kW	750 VA	16A/0,5A/0,35A

It is valid for following products: CRM-93H, SOU-2, HRN-54, HRN-54N, PRI-51, TER-9

relay contact 8 A	Load								
						AC1	AC3	AC15	DC1 (24/110/220V)
AgNi	500 W	x	x	x	x	2000 VA		375 VA	8A/0,4A/0,25A

It is valid for following products: CRM-91H, CRM-2H, CRM-2T, HRN-33, HRN-34, HRN-35, TER-3

relay contact 16 A	Load								
						AC1	AC3	AC15	DC1 (24/110/220V)
AgNi	1000 W	x	x	x	x	4000 VA	0,9 kW	750 VA	16A/0,5A/0,35A

Hour meter HM-1

Technical data	
Mechanical data	description
Display	5 integers, 2 decimals
Digit height	4mm
Counting range	99999,99
Reading accuracy	1/100 h (36sec)
Weight	32g
Electrical data	
Operating voltage	230V +/- 10%, 50Hz
Current consumption	Max. 8mA
Accuracy	+/- 0,02%
IP protection	IP40
Ambient conditions	
Operating temperature	-25°C .. + 70°C
Storage temperature	-40°C .. + 70°C
Relative humidity	Max. 80% / +25°C
Approvals	
	CE Mark RoHS compliant

Dimensions

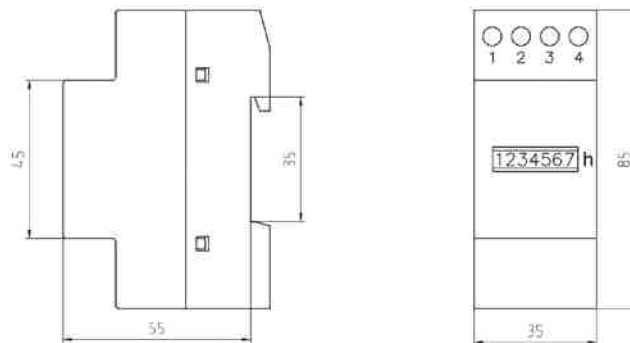

Technical data

Electronic fuse monitor EFM

Technical data		EFM230	EFM400
Input			
Supply voltage AC $\pm 10\%$	V~	230	400
Nominal Frequency	Hz	50-60 (range:47-63)	
Power consumption (max. AC)	VA	3,6	1,5
Output relay			
Rating	-	8A-250V AC /24V DC	
Max switching power	VA	2000	
Max switching voltage	V~	400	
Min switching load	-	10mA 12V dc	
Contact life	-	30x10 ³ ops / 100x10 ³ ops	
Changeover contacts	-	AgNi0.15	
Status indication			
Fuse OK	-	Green LED - Relay ON	
Fuse FAIL	-	Red LED - Relay OFF	
General			
Internal resistance paths	Ω/V	>2000	
Permissible feedback (Ue)	-	max. 90	
Response/Release Time:			
- After Breaking Fuse	ms	<30	
- After Restoring Fuse	ms	<500	
Working temperature	$^{\circ}C$	-20...+50	
Storage temperature	$^{\circ}C$	-30...+70	
Electrical Insulation	kV	4	
Overtoltage Category	-	III	
Protection degree	IP	20	
Pollution degree	-	2	
Climatic category	-	IEC 60068-1 (20/050/60), DIN 40040 (class D)	
Altitude up to	m	2000	
Dimensions	mm	98x35,7x64	

Description

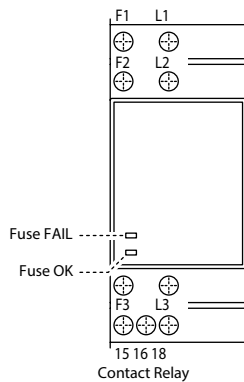

Dimensions

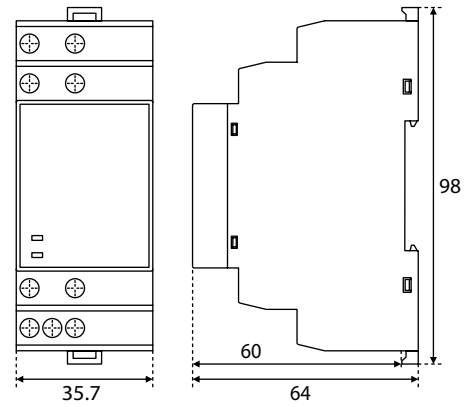

Function

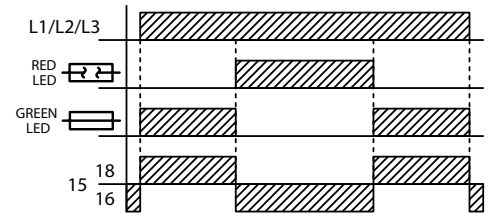

Connection

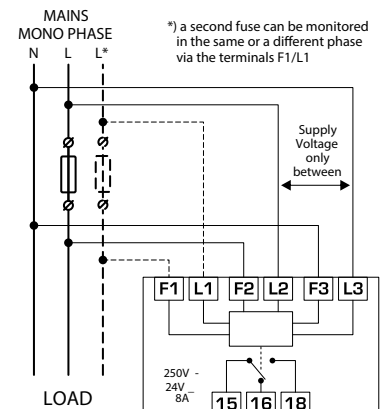
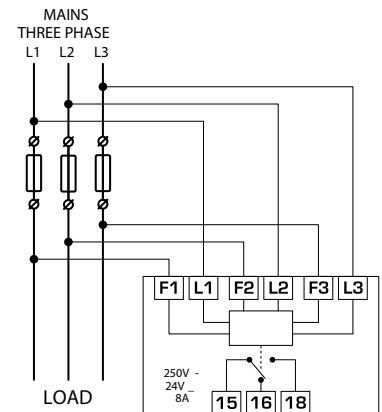

Power supplies PS-30

Technical data		
	PS-30-12	PS-30-24
Input		
Voltage range	AC 100-250V / 50 - 60Hz	
Burden without load (max)	9VA / 1W	10VA/1.5W
Burden with full load (max)	70VA / 37W	
Protection	fuse T2A	
Output		
Output voltage DC / max. current	12.2V/2.5A	24.2V/1.25A
Tolerance of output voltage:	± 2%	
Output indication	green LED	
Wave of off-load output voltage	30mV	
Wave of output voltage with max load	80mV	
Time delay after connection	max. 5s	
Time delay after over-load	max. 1s	
Efficiency	>82%	
Electronic fuse	electronic protections short-circuit, over load, over voltage (from 120% of rated output)	
Other information		
Working humidity	20 .. 90% RH	
Operating temperature	-20 °C ... +40 °C	
Storage temperature	-25 °C ... +70 °C	
Electrical strength input- output	4kV	
Protection degree	IP40 device/ IP20 in-built in distribution board	
Overvoltage category:	II.	
Pollution degree	2	
Max. cable size (mm ²)	solid wire max. 1x2.5 or 2x1.5/ with sleeve max. 1x1.5	
Dimensions	90 x 52 x 65 mm	
Weight	158 g	
Standards	EN 61204-1, EN 61204-3, EN 61204-7	

PS-30: switching stabilized power supplies, version 3-module

- PS-30-12 - stabilized power supply with fixed output voltage 12V/30W
- PS-30-24 - stabilized power supply with fixed output voltage 24V/30W

Connection

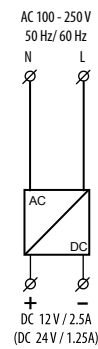

Description

PS-30-12, PS-30-24

Supply terminals

Output voltage indication

Output voltage terminals ⊕

Output voltage terminals ⊖

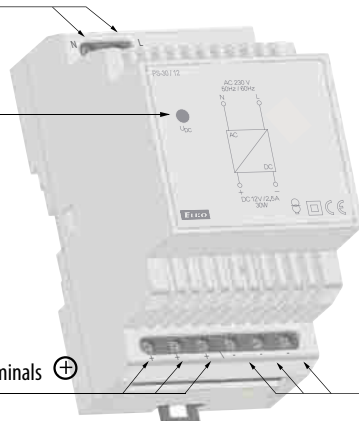

Technical data

Switching Power Supply

Technical data		PS-48-24	PS-72-24	PS-120-24	PS-240-24	PS-480-24
Input						
Supply voltage AC	V AC	100 - 240				
Nominal frequency	Hz	50 - 60 (range: 47 - 63)				
Supply voltage DC	V DC	140 - 340				
Input current at 230VAC	A	0,4	0,97	0,6	1,4	2,4
In-rush current at 230VAC	A	15	20	25	30	50
Input overload protection T-type fuse (internal)	A	2	3,15	5	5	6,3
Power Factor at 230VAC	-	0,5	0,5	0,96	0,92	0,97
Output						
Output adjustable voltage DC	V DC	24 - 28 ($\pm 2\%$)				
Max. continuous output current	A	2	3	5	10	20
Max. continuous output power	W	45	75	120	240	480
Ripple BW 20MHz at max. load	mV	120	120	80	100	150
Hold-up time at rated V AC and max. load	ms	20				
Rise time at rated V AC	ms	200			60	
Parallel connection	-	x				✓
Output overvoltage protection min. % of Vout	%	120 - 135	120 - 135	110 - 140	120 - 150	110 - 140
Output overload protection % of max. load	%	110 - 150				
Power good relay	%	x	x	✓	✓	✓
General						
Efficiency at rated V AC	%	88,5	89,5	92	93	93
Working temperature - free convection	°C	-25 ... +70				
De-rating 2,5% In/°C	°C	> 55				
Storage temperature	°C	-40 ... +85				
Electrical Insulation	kV	3 (IN/OUT) 1,5 (IN/⊕) 0,5 (OUT/⊕)				
Over-temperature protection	-	✓				
Protection degree	IP	20				
Relative Humidity w/o cond.	RH%	90				
Altitude up to	m	2000				
Dimensions	mm	130x35x110	130x35x110	130x40x120	130x62x125	138x86x125

Dimensions

PS-48-24 & PS-72-24

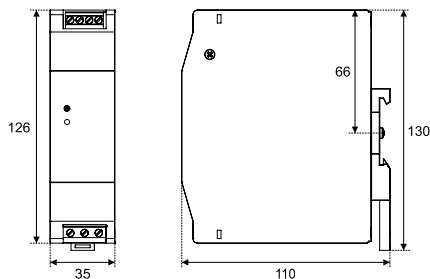

PS-240-24

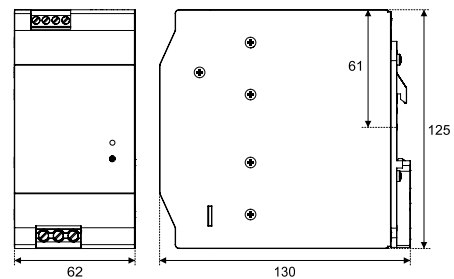

PS-120-24

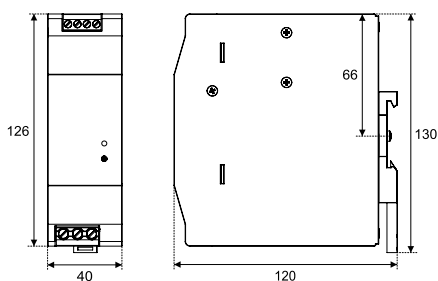

PS-480-24

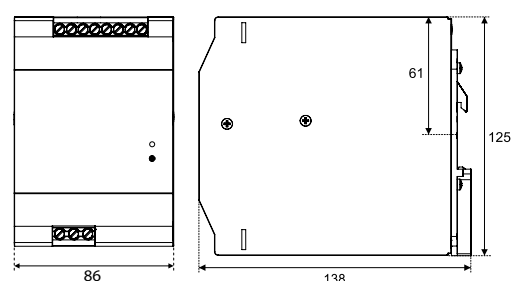

Description

PS-48-24 & PS-72-24

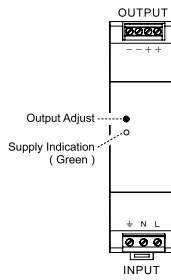

PS-120-24

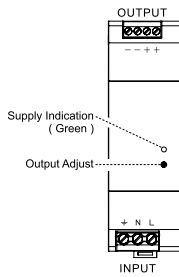

PS-240-24

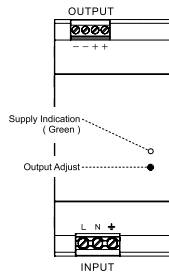

PS-480-24

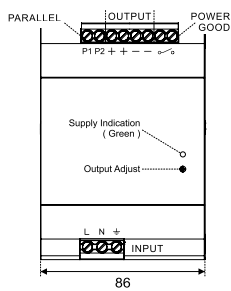

Connection

PS-48-24 & PS-72-24

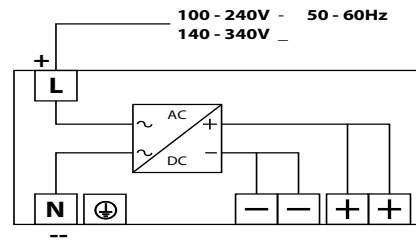

PS-120-24

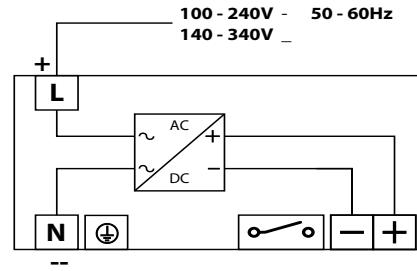

PS-240-24

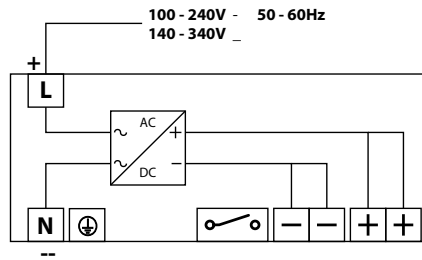

PS-480-24

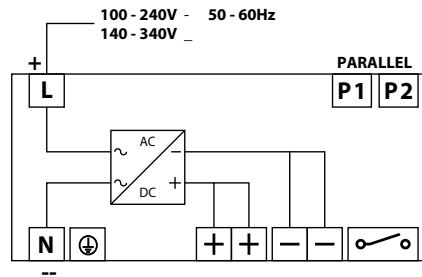

Install rail: TS35/7.5 or TS35/15

POWER GOOD:

Relay closed: power supply (Output) is stable and within the tolerance limits.

Relay opened: power supply (Output) out of tolerance limits. Power cut off – to prevent damages on sensitive loads.

PARALLEL P1 P2:

Parallel connection of up to 10 power supplies. Connect P1s with P1s, P2s with P2s of each power supply wired in parallel (+ and – outputs in parallel). Each power supply unit must have connection to supply (Input)

Electromechanical power relays RERM3

Table 1: Technical data		RERM3
Contact Data		
Number and type of contacts		3 CO
Contact material		AgNi
Rated / max. switching voltage AC		440 V
Min. switching voltage		5V
Rated load (capacity)		16 A / 250 V AC 10 A / 400 V AC
Min. switching current		5 mA
Max. inrush current		40A
Rated current		16A
Max. breaking capacity AC1		4000 VA
Min. breaking capacity		0.3W
Contact resistance		≤ 100 mΩ
Max. operating frequency (cycles/hour)		
• at rated load AC1		1 200
• no load		12 000
Coil data		
Rated voltage		AC: 24V, 240V
Must release voltage		AC: ≥ 0,15 Un
Operating range of supply voltage		see next page
Rated power consumption		2,8 VA (50Hz) / 2,5 VA (60Hz)
Insulation according to EN 60664-1		
Insulation rated voltage		400 V AC
Rated surge voltage		4 000 V 1,2 / 50 μs
Overvoltage category		III
Insulation pollution degree		2
Dielectric strength between coil and contacts (basic insulation)		2500 V AC
Dielectric strength - contact clearance		
- micro disconnection		1500 V AC
- full disconnection with contact gap ≥ 3mm		2500 V AC
Dielectric strength pole-pole (basic insulation)		2500 V AC
Contact - coil distance		
- Clearance	≥ 5 mm 2CO, 2NO	≥ 4 mm 3CO, 3NO
- Creepage	≥ 8 mm 2CO, 2NO	≥ 5 mm 3CO, 3NO
General data		
Operating / release time (typical values)		20 ms / 15 ms
Electrical life		
- Resistive AC1		>10 ⁵ 16 A, 250 V AC / 10 A, 400 V AC
- cos φ		See next page
Mechanical life (cycles)		>10 ⁷
Dimensions		36,1 x 38,6 x 45,5 mm
Ambient temperature		
- storage		- 40...+85°C
- operating		- 40...+55°C
Cover protection category		IP 00
Environmental protection		RTI
Shock resistance (NO/NC)		10 g
Vibration resistance		5g 10...150 Hz
Solder bath temperature		max. 270°C
Soldering time		max. 5s

Table 2: Coil data

Coil code	Rated voltage V AC	Coil resistance at 20 °C Ω	Acceptable resistance	Coil operating range V AC	
				min. (at 20 °C)	max. (at 55 °C)
024AC	24	75	± 15%	19,2	26,4
230AC	230	7080	± 15%	184,0	253,0

Dimensions

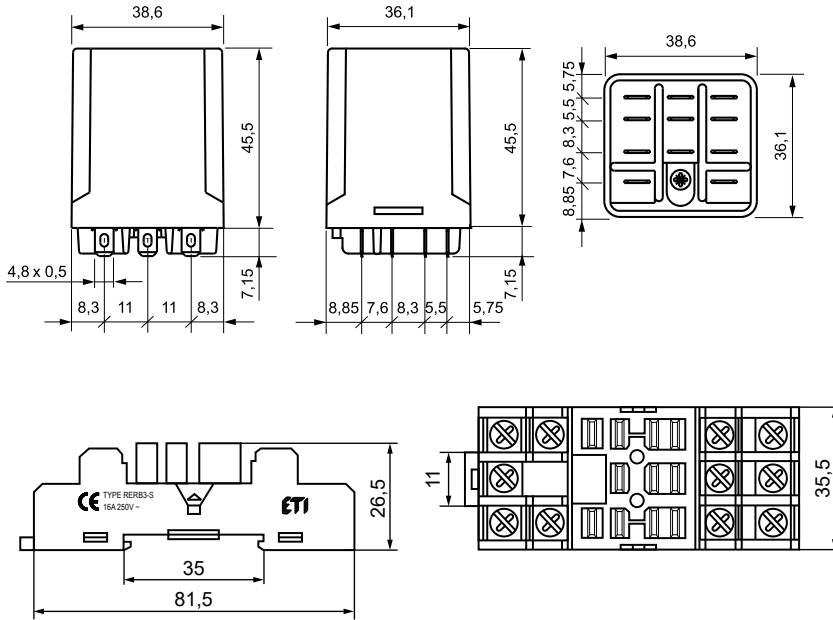

Connection diagram (pin side view)

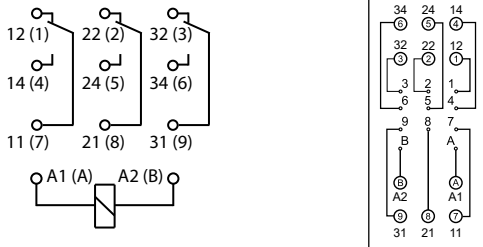

Electrical life at AC resistive load.
Switching frequency: 1 200 cycles/hour

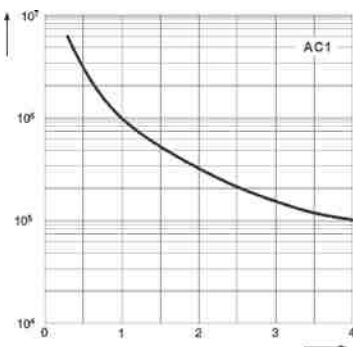

Electrical life reduction factor at AC inductive load

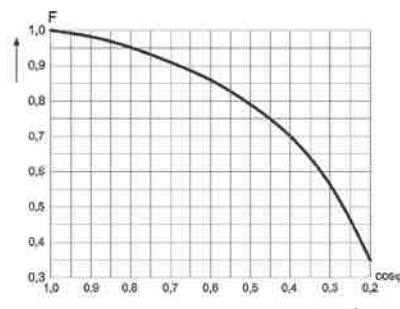

Technical data

Industrial plugin electromagnetic relays

Relays for general application

For plug-in sockets: 35 mm rail mount acc. to EN 60715; panel mounting

Miniature dimensions

Cadmium - free contacts

AC and DC coils

Recognitions, certifications, directives: RoHS, CE

Standards: EN61810-1:2008 (electromechanical relays); EN61984:2002, EN60998-2-1:2001, EN60664-1:2003 (sockets)

Table 1: Technical data

	ERM2	ERM4
Number and type of contacts	2 CO	4 CO
Contact material	AgNi	
Rated / max. switching voltage AC	250 V / 440 V	250 V / 250 V
Min. switching voltage	10 V	10 V AgNi, 10 V AgNi/Au 0,2 µm, 5 V AgNi/Au 5 µm
Rated load (capacity)		
AC1	12 A / 250 V AC	6 A / 250 V AC
AC15	3 A / 120 V 1,5 A / 240 V	1,5 A / 120 V 0,75 A / 240 V (C300)
AC3	370 W (single-phase motor)	125 W (single-phase motor)
DC1	12 A / 24 V DC (see Fig. 3)	6 A / 24 V DC (see Fig. 3)
DC13	0,22 A / 120 V 0,1 A / 250 V	0,22 A / 120 V 0,1 A / 250 V (R300)
Min. switching current	5 mA	
Max. inrush current	24 A	12 A
Rated current	12 A	6 A
Max. breaking capacity AC1	3 000 VA	1 500 VA
Min. breaking capacity	0,3 W	0,3 W AgNi, 0,3 W AgNi/Au 0,2 µm, 0,1 W AgNi/Au 5 µm
Contact resistance	≤ 100 mΩ	
Max. operating frequency (cycles/hour)		
• at rated load AC1	1 200	
• no load	18 000	
Coil data		
Rated voltage 50/60 Hz AC DC	See table 2	
Must release voltage	AC: ≥ 0,2 Un DC: ≥ 0,1 Un	
Operating range of supply voltage	see Table 2	
Rated power consumption AC DC	1,6 VA 0,9 W	
Insulation according to EN 60664-1		
Insulation rated voltage	250 V AC	
Rated surge voltage	4 000 V 1,2 / 50 µs	2 500 V 1,2 / 50 µs
Overtoltage category	III	II
Insulation pollution degree	3	2
Dielectric strength		
• between coil and contacts	2 500 V AC type of insulation: basic	
• contact clearance	1 500 V AC type of clearance: micro-disconnection	
• pole - pole	2 500 V AC type of insulation: basic	
Contact - coil distance		
• clearance	≥ 2,5 mm	≥ 1,6 mm
• creepage	≥ 4 mm	≥ 3,2 mm
General data		
Operating / release time (typical values)	AC: 10 ms / 8 ms DC: 13 ms / 3 ms	
Electrical life		
• resistive AC1	> 10 ⁵ 12 A, 250 V AC	
• cosΦ	see Fig. 2	
Mechanical life (cycles)	> 2 x 10 ⁷	
Dimensions (L x W x H)	27,5 x 21,2 x 35,6 mm	
Weight	35 g	
Ambient temperature		
• storage	-40...+85 °C	
• operating	AC: -40...+55 °C	DC: -40...+70 °C
Cover protection category	IP 40 EN 60529	
Environmental protection	RTI EN 116000-3	
Shock resistance (NO/NC)	10 g / 5 g	
Vibration resistance	5 g 10...150 Hz	

Table 2: Coil data

DC voltage version					
Coil code	Rated voltage V DC	Coil resistance at 20 °C Ω	Acceptable resistance	Coil operating range V DC	
				min. (at 20 °C)	max. (at 20 °C)
012DC	12	160	± 10%	9,6	21,6
024DC	24	640	± 10%	19,2	43,2
048DC	48	2600	± 10%	38,4	86,4
110DC	110	13600	± 10%	88	198
220DC	220	54000	± 10%	176	250

AC voltage version					
Coil code	Rated voltage V DC	Coil resistance at 20 °C Ω	Acceptable resistance	Coil operating range V AC	
				min. (at 20 °C)	max. (at 20 °C)
024AC	24	158	± 10%	19,2	25,3
230AC	230	16100	± 10%	184,0	253

Dimensions

ERM 2

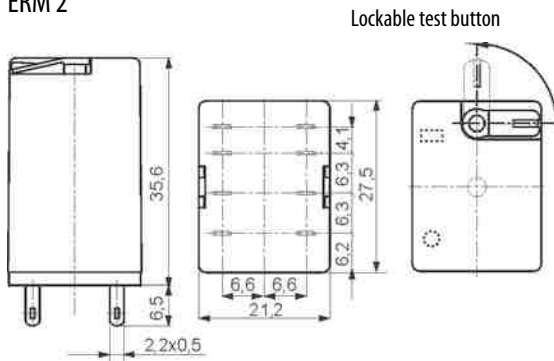

ERM 4

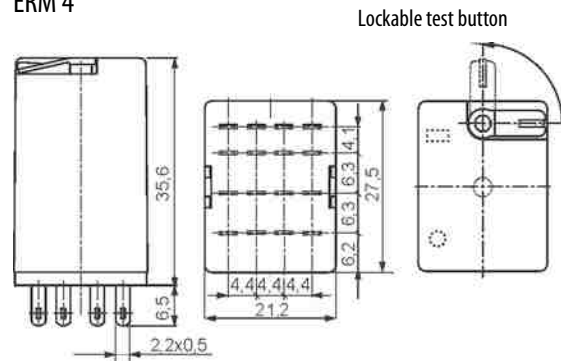

Connection diagram (pin side view)

ERM 2

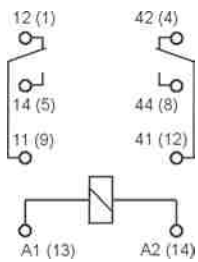

ERM 4

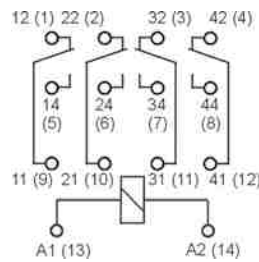

Ordering designation
 ERMX-YYYYYZ

X - Number of contacts:
 4: 4 CO (4 changeover)
 2: 2 CO (2 changeover)

Z - Additional features:
 L - Light indicator (smd LED - red)

Example:
 ERM4-024DCL Electromagnetic relay for plugin sockets with mechanical indication and lockable test button, four changeover contacts, coil voltage 24 V DC with light indicator.

YYYYY - Coil code:
 024AC: 24 V AC 50/60 Hz
 230AC: 230 V AC 50/60 Hz
 024DC: 24 V DC
 012DC: 12 V DC

Meaning of color codes:



Electrical life at AC resistive load. Switching frequency: 1 200 cycles/hour Fig. 1

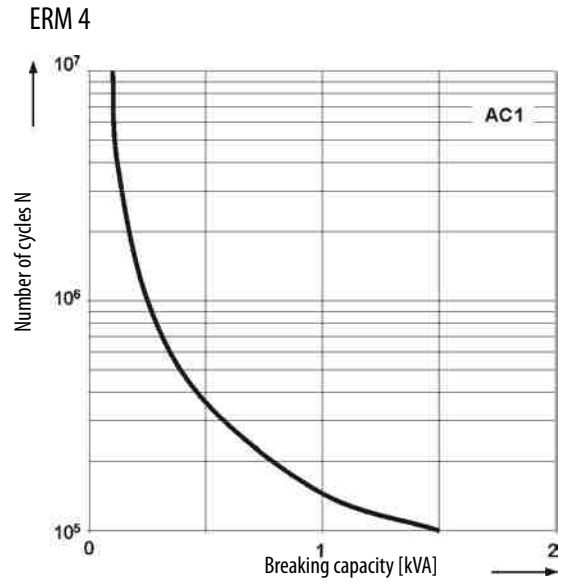
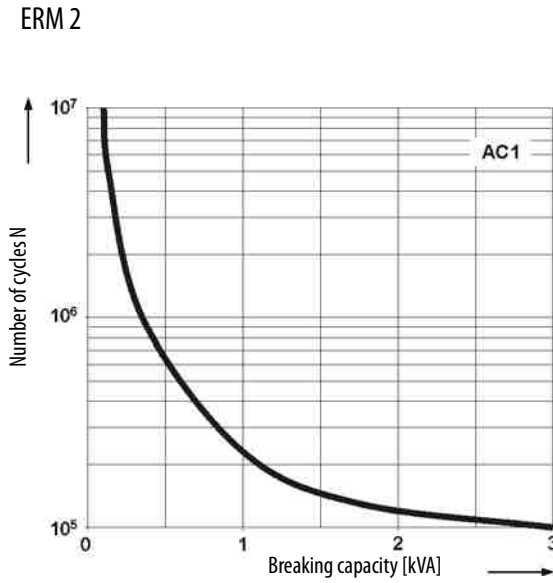

Electrical life reduction factor at AC inductive load Fig. 2

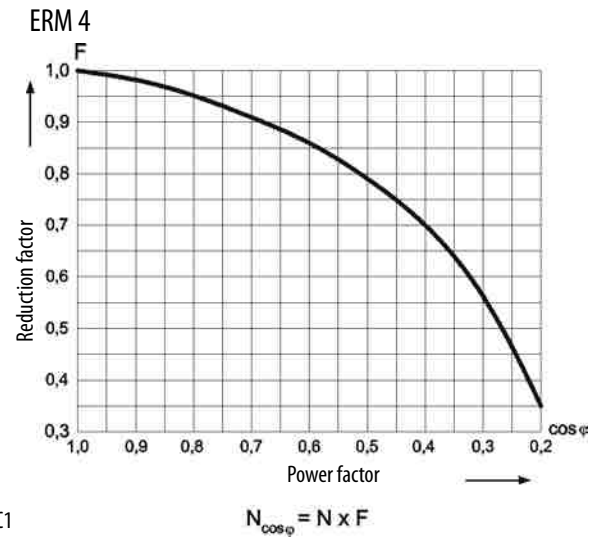
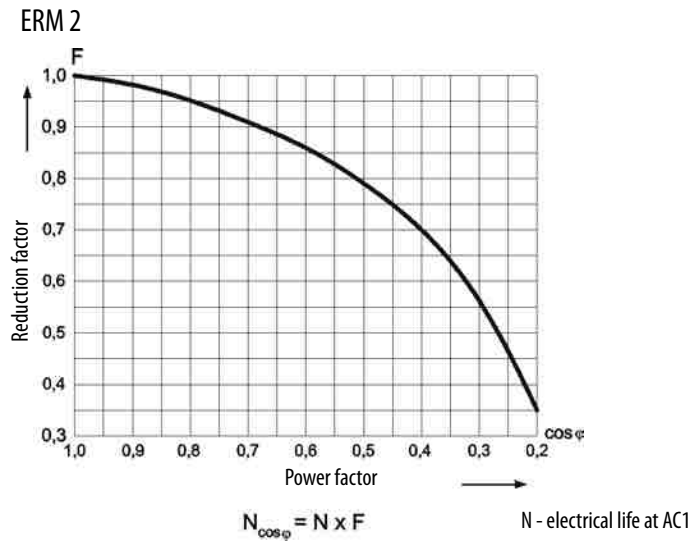

Max. DC resistive load breaking capacity Fig. 3

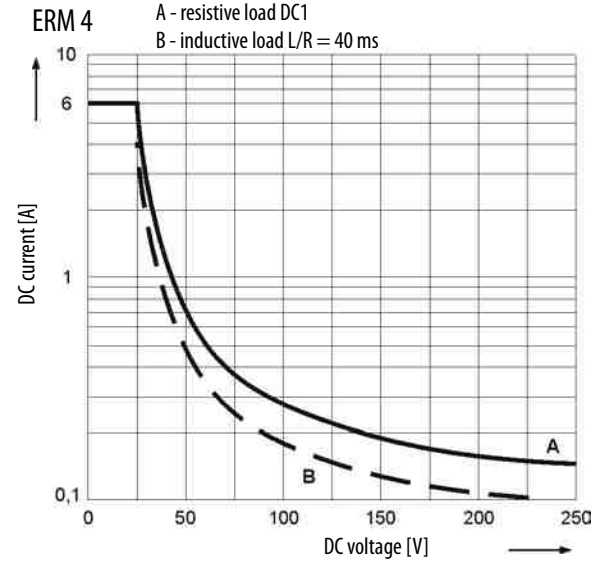
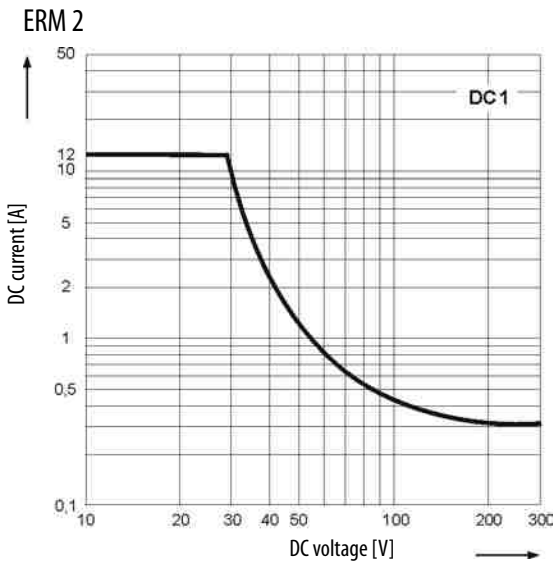

Contact material selection for different load types ERM2 and ERM4

AgNi - for resistive or inductive loads,

Mounting

ERM 2

Relays ERM2 are designed for mounting in plug-in sockets, standard version includes mechanical indicator with lockable front test button.

Relays ERM2 are designed for:

- screw terminals plug-in
- sockets ERB2-T*
- sockets ERB2-M* with clip ER-CLIP
- 35 mm rail mount acc. to EN 60715 or
- panel mounting

protecting modules type ERC are available as accessories /sockets (see below)

*Plug-in sockets ERB2-T and ERB2-M may be linked with interconnection strip type ER-TERMINAL

ERM 4

Relays ERM4 are designed for mounting in plug-in sockets, standard version includes mechanical indicator with lockable front test button.

Relays ERM4 are designed for:

- screw terminals plug-in
- sockets ERB4-T*
- sockets ERB4-M* with clip ER-CLIP
- 35 mm rail mount acc. to EN 60715 or
- panel mounting

protecting modules type ERC are available as accessories /sockets (see below)

*Plug-in sockets ERB4-T and ERB4-M may be linked with interconnection strip type ER-TERMINAL

Plugin Sockets And Accessories

ERB2-T and ERB4-T

Plugin sockets (base) type T

- Screw terminals
- Max. tightening moment for the terminal: 0,7 Nm
- 35 mm rail mount acc. to EN 60715
- or on panel mounting
- 76,3 x 27 x 42,5(80) mm*

*In the bracket the height of socket with retainer / retractor clip is shown.

Two poles

12A, 300 V AC

For ERM2

Connection diagram

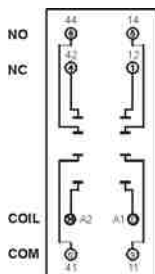

Four poles

6A, 300 V AC

For ERM4

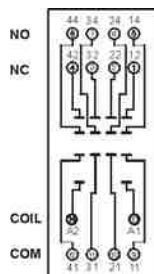

Dimensions

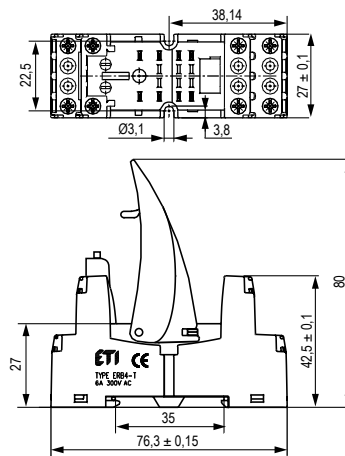

Technical data

ERB2-M and ERB4-M
Plugin sockets (base) type M

- Screw terminals
- Max. tightening moment for the terminal: 0,7 Nm
- 35 mm rail mount acc. to EN 60715
- or on panel mounting
- 75 x 27 x 61(82) mm*

*In the bracket the height of socket with retainer / retractor clip is shown.

Two poles

12A, 300 V AC

For ERM2

Four poles

6A, 300 V AC

For ERM4

Connection diagram

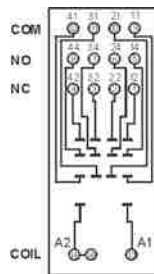
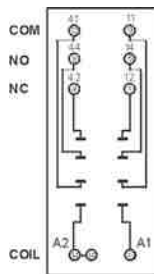

Dimensions

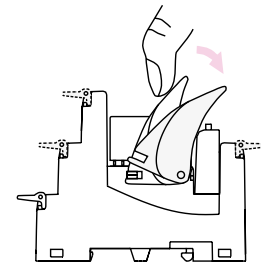
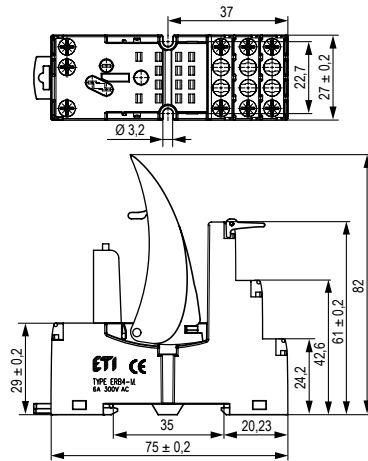

Removing the relay from the socket with a retractor / retractor clip

Protection RC modules type ERC_AC

It protects against EMC disturbance and limits overvoltage.		6/24 V AC	ERC-024AC
		110/240 V AC	ERC-230AC

Protection RC modules type ERC_ACDCL

It limits overvoltage on AC and DC coils. Coil energizing indication.		6...24 V ACDC	ERC-024ACDCL
		24...60 V AC DC	ERC-060ACDCL
		110...230 V ACDC	ERC-230ACDCL



Modules are parallely connected with relay coil

Interconnection strip ER-CLIP

designed for the co-operation with plug-in sockets ERB of miniature industrial relays, which are equipped with screw terminals; sockets and relays are mounted on 35 mm rail mount acc. to EN 60715.

- bridges common input signals (coil terminals A1 or A2)
- maximum permissible current is 10 A / 250 V AC,
- possibility of connection of 6 sockets or relays

Dimensions

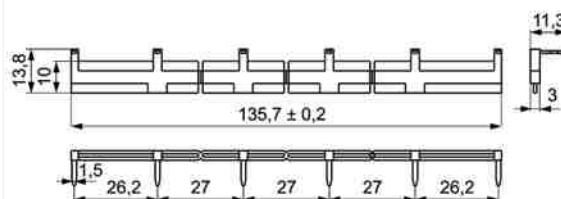

Miniature Electromagnetic Relays

Table 1: Technical data		MER2
Number and type of contacts		2 CO
Contact material		AgNi
Rated / max. switching voltage	AC	250 V / 440 V
Min. switching voltage		5 V AgNi
Rated load (capacity)		
AC1		8 A / 250 V AC
AC15		3 A / 120 V 1,5 A / 240 V (B300)
AC3		550 W (single-phase motor)
DC1		8 A / 24 V DC (see Fig. 3)
DC13		0,22 A / 120 V 0,1 A / 250 V (R300)
Min. switching current		5 mA AgNi
Rated current		8 A
Max. breaking capacity	AC1	2000 VA
Min. breaking capacity		0,3 W AgNi
Contact resistance		≤ 100 mΩ
Max. operating frequency (cycles/hour)		
• at rated load	AC1	600
• no load		72 000
Coil data		
Rated voltage	50/60 Hz AC DC	12 ... 240 V 3 ... 110 V
Must release voltage		AC: ≥ 0,15 U _n DC: ≥ 0,1 U _n
Operating range of supply voltage		See Tables 1, 2 and Fig. 4, 5
Rated power consumption	AC DC	0,75 VA 0,4 ... 0,48 W
Insulation according to EN 60664-1		
Insulation rated voltage		400 V AC
Rated surge voltage		4000 V 1,2 / 50 μs
Overtoltage category		III
Insulation pollution degree		3
Dielectric strength		
• between coil and contacts		5000 V AC type of insulation: reinforced
• pole - pole		2500 V AC type of insulation: basic
Contact - coil distance		
• clearance		≥ 10 mm
• creepage		≥ 10 mm
General data		
Operating / release time (typical values)		7 ms / 3 ms
Electrical life		
• resistive AC1		> 10 ⁵ 8 A, 250 V AC
• cosΦ		see Fig. 2
• DC L/R = 40 ms		> 10 ⁵ 0,15 A, 220 V DC
Mechanical life (cycles)		> 3x10 ⁷
Dimensions (L x W x H)		29 x 12,7 x 15,7 mm
Weight		14 g
Ambient temperature		
• storage		-40 ... +85 °C
• operating		AC: -40 ... +70 °C DC: -40 ... +85 °C
Cover protection category		IP40 / IP67
Environmental protection		RTII / RTIII
Shock resistance (NC)		20 g
Vibration resistance		5 g 10 ... 150 Hz
Solder bath temperature/ soldering time		max. 270 °C / max. 5 s

Technical data

Table 2: Coil data

DC voltage version					
Coil code	Rated voltage V DC	Coil resistance at 20 °C Ω	Acceptable resistance	Coil operating range V DC	
				min. (at 20 °C)	max. (at 20 °C)
005DC	5	60	± 10%	3,5	12,7
012DC	12	360	± 10%	8,4	30,6
024DC	24	1440	± 10%	16,8	61,2
AC 50/60 Hz voltage version					
024AC	24	400	± 10%	19,2	28,8
230AC	230	38 500	± 10%	184,0	276,0

Dimensions

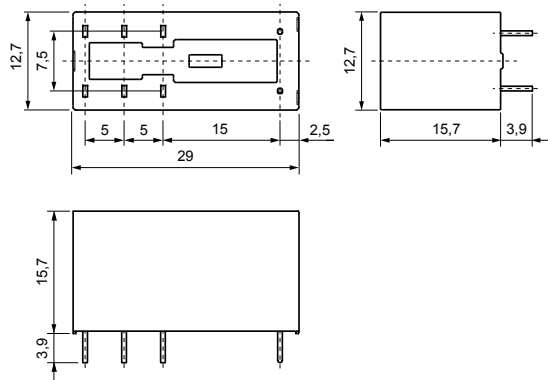

Connection diagram (pin side view)

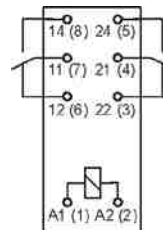

Terminal (pin)	A1(1); A2(2)	22(3); 21(4); 24(5); 12(6); 11(7); 14(8)
[mm]	Ø 0,6	0,5 x 0,9
Drilling hole:		
• for relays Ø 1,3 + 0,1 mm		
• for sockets Ø 1,5 + 0,1 mm		

Electrical life at AC resistive load.
Switching frequency: 600 cycles/hour

Fig. 1

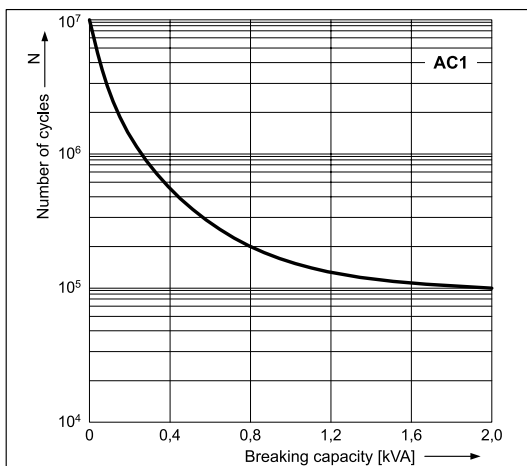

Electrical life reduction factor at AC inductive load

Fig. 2

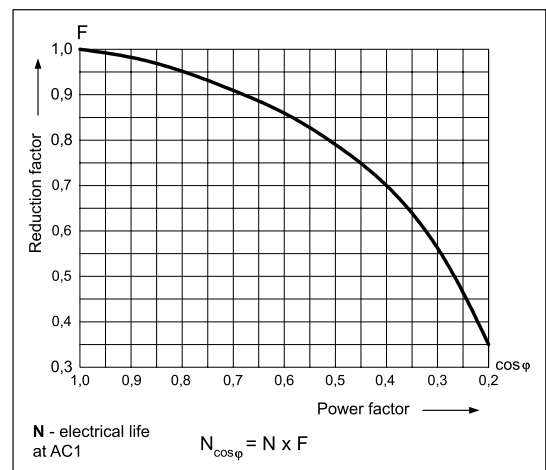

Max. DC resistive load breaking capacity

Fig. 3

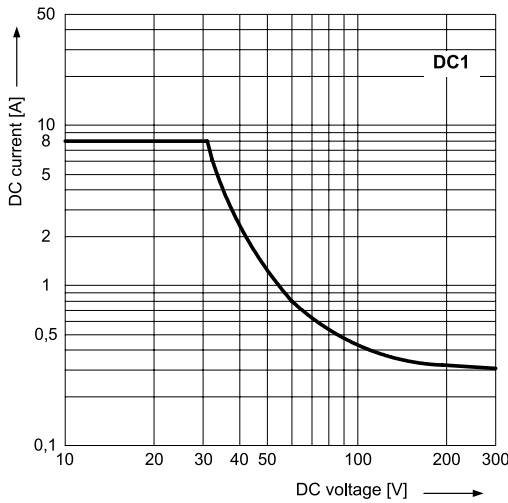

Coil operating range = DC

Fig. 4

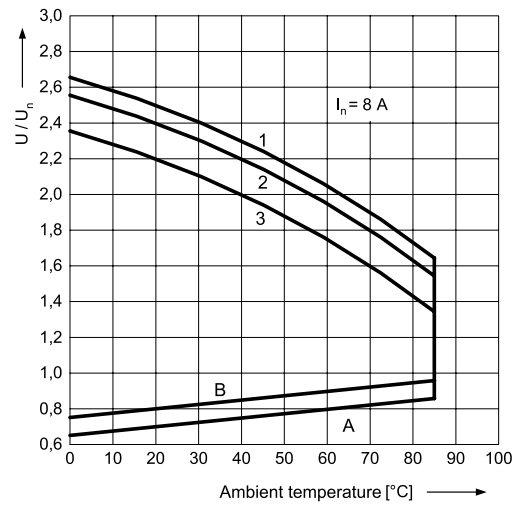

Coil operating range = AC 50 Hz

Fig. 5

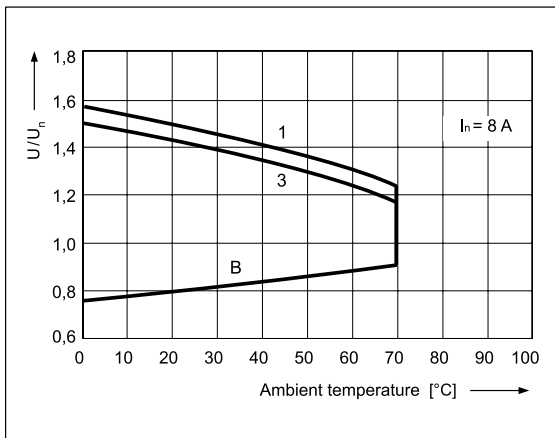

Description of Fig. 4 and 5

A - relations between make voltage and ambient temperature at no load on contacts. Coil temperature and ambient temperature are equal before coil energizing. Make voltage is not higher than the value read on Y axis (multiplication of rated voltage).

B - relations between make voltage and ambient temperature after initial coil heating up with $1,1 U_n$ at continues load of I_n on contacts. Make voltage is not higher than the value read on Y axis (multiplication of rated voltage).

1, 2, 3 - values on Y axis represent allowed overvoltage on coil at certain ambient temperature and contact load:

- 1 - no load
- 2 - 50% of rated load
- 3 - rated load

Pinout (soldier side view)

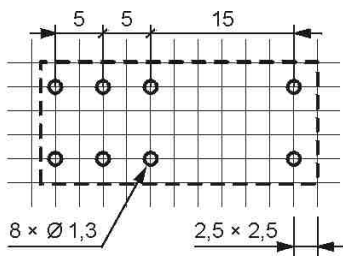

Mounting

Relays MER2 are designed for:

- direct PCB mounting
- screw terminals plug-in sockets MERB-T and MERB-M

Plugin Sockets And Accessories

MERB-T
Plugin sockets (base) type T

- Screw terminals
 - Max. tightening moment for the terminal: 0,7 Nm
 - 35 mm rail mount acc. to EN 60715
 - or on panel mounting
 - 75,3 x 15,5 x 61(67) mm*
- *In the bracket the height of socket with retainer / retractor clip is shown.

MERB-M
Plugin sockets (base) type M

- Screw terminals
 - Max. tightening moment for the terminal: 0,7 Nm
 - 35 mm rail mount acc. to EN 60715
 - or on panel mounting
 - 78,1 x 15,9 x 61(66,5) mm*
- *In the bracket the height of socket with retainer / retractor clip is shown.

Two poles, 5mm pinout

12A, 300 V AC

Dimensions

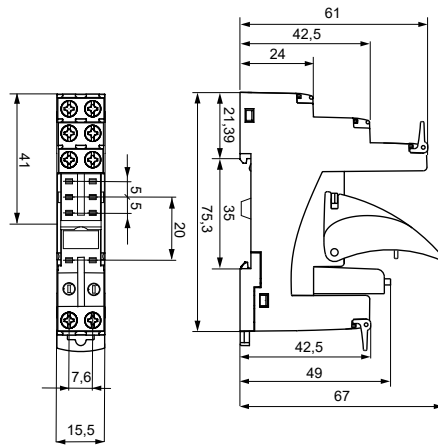

Connection diagram

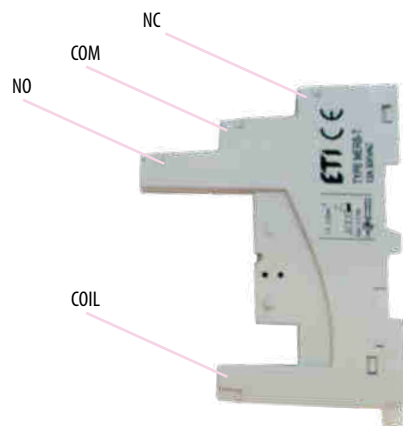
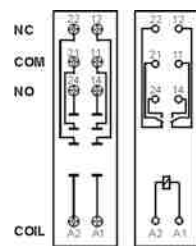

Two poles, 5mm pinout

12A, 300 V AC

Dimensions

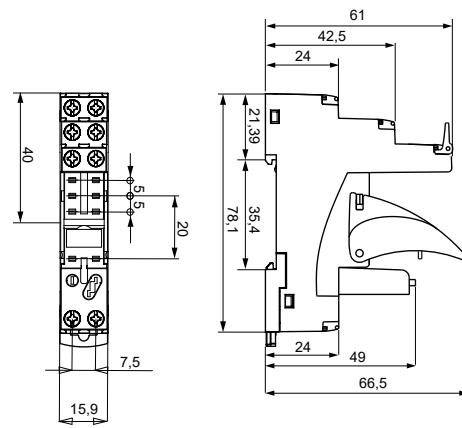

Connection diagram

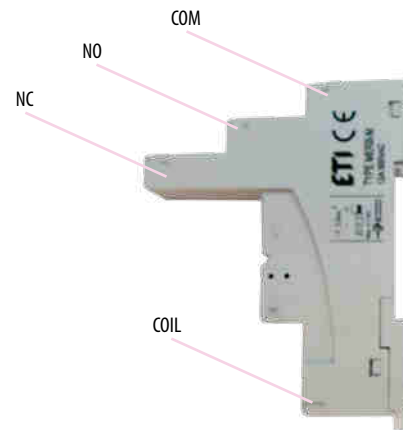
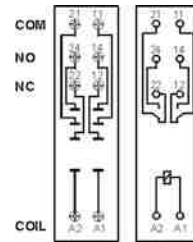

SLIM RELAYS SSR & SER, Electromagnetic and solid

Table 1: Technical data

	SER1; Contact data	SSR1; Output circuit - Triac
Number and type of contacts	1 CO	1 NO
Contact material	AgSnO2	-
Rated / max. switching voltage AC	400 V AC / 250 V DC	400 V AC / 440 V AC
Min. switching voltage	10 V AC / DC	20 V AC
Rated load (capacity)		
AC1	6 A / 250 V AC	1,2 A / 400 V AC
DC1	6 A / 24 V DC; 0,15 A / 250 V DC	-
Min. switching current	100 mA	10 mA
Max. inrush current/Max. non-repeat surge current	10 A (t=20 ms)	30 A (t=20 ms)
Rated current	6 A	1,2 A
Max. breaking capacity AC1	1 500 VA	-
Min. breaking capacity	1 W	-
Contact resistance	≤100 mΩ 100 mA, 24 V	-
Max. operating frequency (cycles/hour)		
• at rated load AC1	360	-
• no load	72 000	-
I ² t for fusing	-	5,1 A ² s (t=1-10 ms)
di/dt	-	50 A/μs
dV/dt	-	40 V/μs
Input circuit		
Rated voltage AC: 50/60 Hz AC/DC	24 V; 230 V	
Must release voltage / Turn-off voltage	AC: ≥ 0,2 Un DC: ≥ 0,1 Un	
Must operate voltage	AC & DC: ≤ 0,8 Un	-
Rated power consumption AC/DC	0,3 ... 1,6 VA / 0,3 ... 1,6 W	0,3 VA / 0,3 W 24 V AC/DC
	-	1,6 VA / 1,6 W 230 V AC/DC
Insulation according to PN-EN 60664-1		
Insulation rated voltage	400 V AC	600 V AC
Rated surge voltage	4 000 V 1,2 / 50 μs	-
Overtoltage category	III	-
Insulation pollution degree	3	2
Dielectric strength		
• input - output	4 000 V AC 50/60 Hz, 1 min. (type of insulation: reinforced)	4 000 V AC 50/60 Hz, 1 min. (type of insulation: reinforced)
• input - output	6 000 V 1,2 / 50 μs	-
• mass - input, output	2 500 V AC 50/60 Hz, 1 min.	-
• contact clearance	1 000 V AC 50/60 Hz, 1 min. (type of clearance: micro-disconnection)	-
Input - output distance		
• clearance	≥ 6 mm	-
• creepage	≥ 8 mm	-
General data		
Operating / release time (typical values)	AC: 7 ms DC: 6 ms / AC: 15 ms DC: 10 ms	10 ms max. (zero turn-on) / 10 ms max.
Electrical life		
• resistive AC1 (cos φ = 0,4)	> 0,6 x 10 ⁵ 6 A, 250 V AC; > 2 x 10 ⁵ 2 A, 250 V AC	-
• resistive DC1	10 ⁵ 6 A, 30 V DC	-
Mechanical life (cycles)	> 2 x 10 ⁷	-
Dimensions (L x W x H)	93,8 x 6,2 x 80 mm	
Weight	40 g	
Ambient temperature		
• storage	-40...+70 °C	-40...+70 °C
• operating	-40...+55 °C (-40...+60 °C 24 V DC)	-40...+55 °C
Protection category	IP 20 PN-EN 60529	
Environmental protection	RTI PN-EN 116000-3	
Shock resistance	10 g	
Vibration resistance	5 g 10...500 Hz	

Technical data

Input data SER1

Interface relay code	Rated input voltage, Un	Power of input circuit	Input - voltage range, V	
			min. (20 °C)	max. (55 °C)
SER1-024ACDC	24 V AC/DC	0,5 VA / 0,5 W	19,2	26,4
SER1-230ACDC	230 V AC/DC	0,8 VA / 0,8 W	184,0	253,0

Input data SSR1

Interface relay code	Rated input voltage Un	Power of input circuit
SSR1-230ACDC	230 V AC/DC	1,6 VA / 1,6 W

Dimensions

SER1-024ACDC / SER1-230ACDC

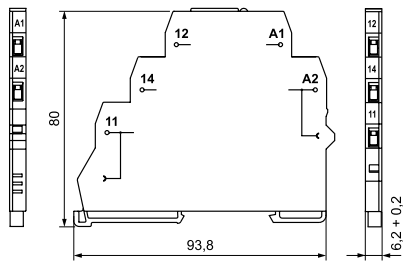

SSR1-024ACDC / SSR1-230ACDC

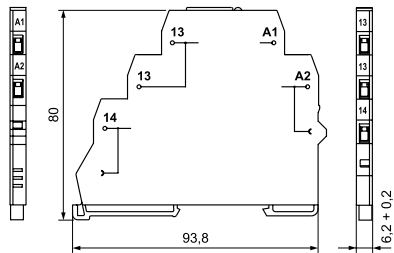

SR-TERMINAL

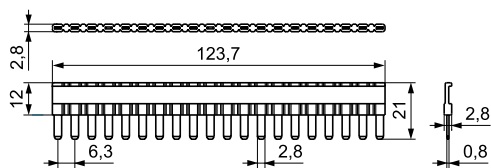

Connection diagram

SER1-024ACDC

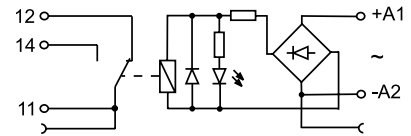

SER1-230ACDC

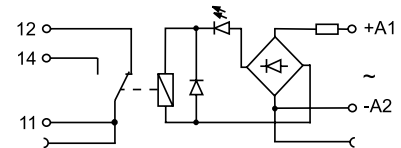

SSR1-024ACDC
SSR1-230ACDC

