

CH 10 - Fuse-links



General characteristics

Rated voltage	700V a.c./d.c. L/R=2ms
Breaking capacity	50kA a.c./8kA d.c.
Standards	IEC 60269-4
Characteristic	gR

CH 10

Size	I_n [A]	Code No. "standard contacts"	Code No. "type SU contacts"	Pre-arcing Joule integral [A ² s] L/R=2ms	Operating Joule integral [A ² s] L/R=2ms	Power dissipation [0,7 x I _n ²] P _d [W]	Power dissipation [I _n ²] P _d [W]	Weight [g]	Packaging [pcs]
10 x 38	2	002625017	002625300	1,2	1,41	0,44	1,10	10/12	10/500 SU:10/380
	4	002625018	002625301	7,6	28	0,55	1,30		
	6	002625019	002625302	14	63	0,73	1,70		
	8	002625020	002625303	30	98	0,70	1,62		
	10	002625021	002625304	20	73	0,98	2,44		
	12	002625022	002625305	48	122	0,82	1,85		
	16	002625023	002625306	97	182	1,06	2,61		
	20	002625024	002625307	164	301	1,27	3,00		
	25	002625025	002625308	246	434	1,61	4,00		



Type SU Contacts



Standard Contacts

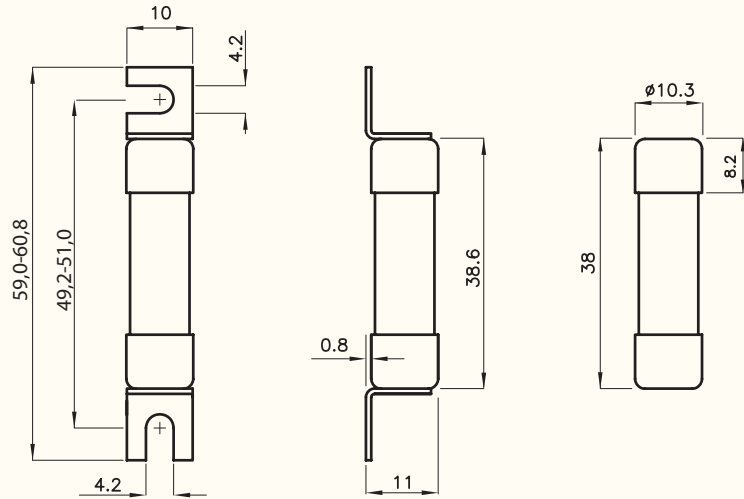

Tamb (°C)	A1
-20	1,196
-10	1,153
0	1,109
10	1,063
20	1,015
30	0,964
40	0,911
50	0,854
60	0,794
70	0,728
80	0,656

CH10x38 PV temperature derating factor

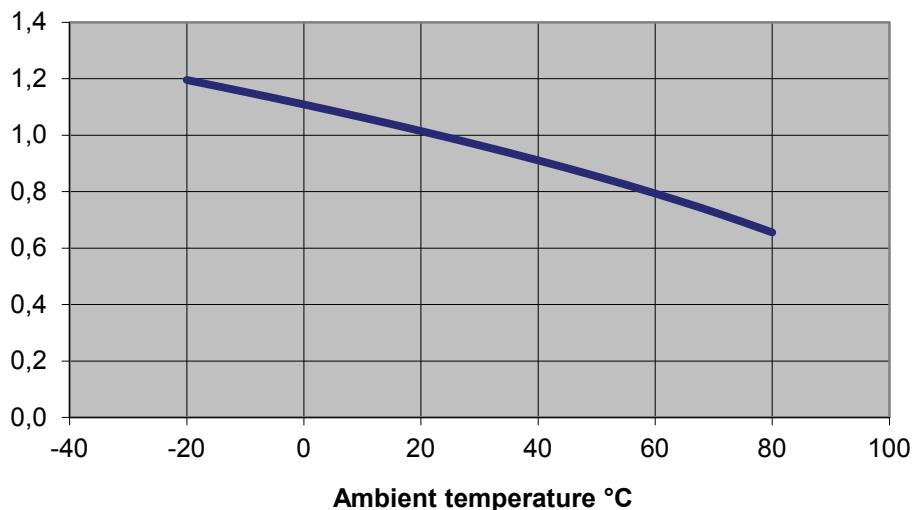

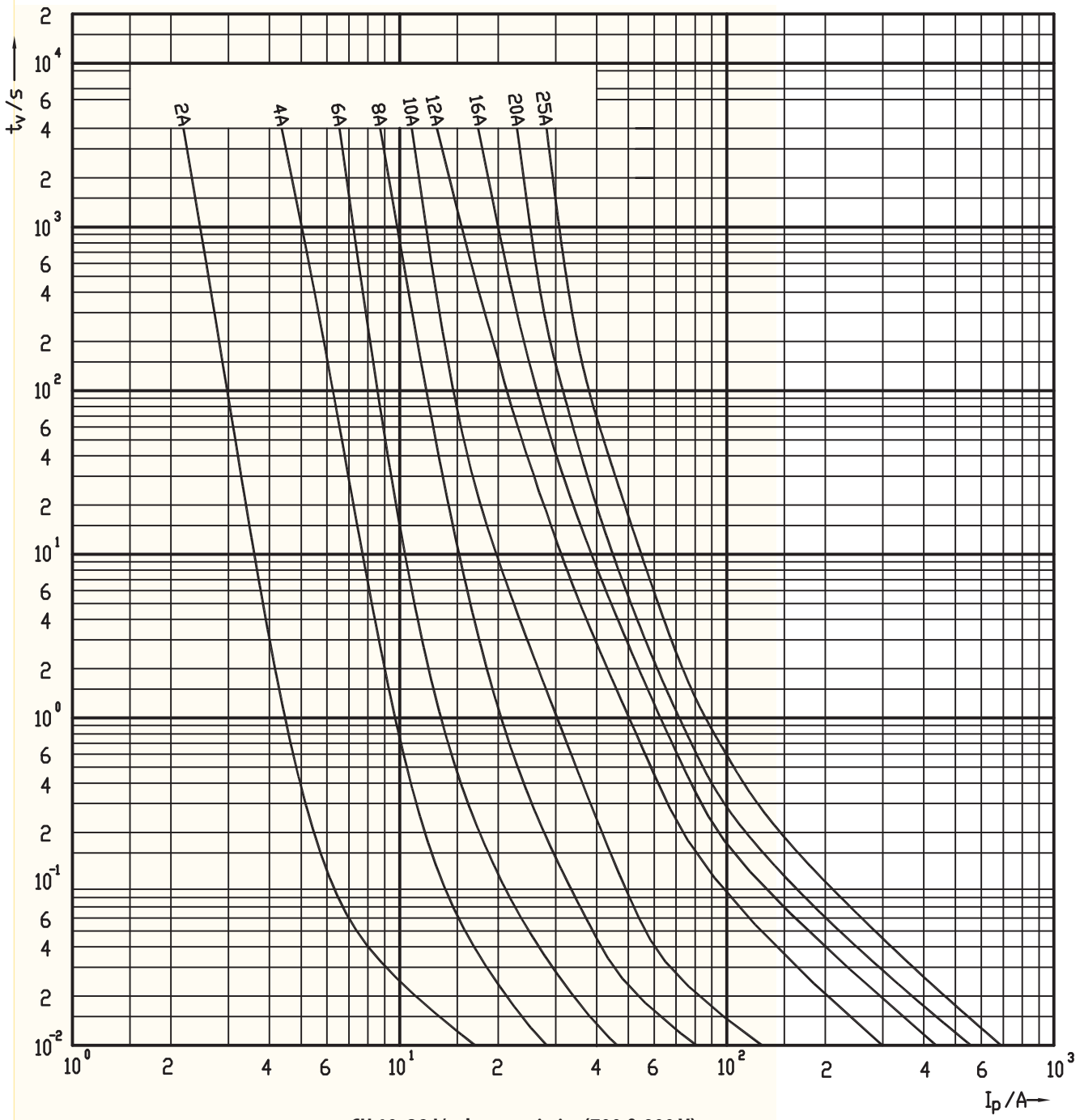

CH 10x38 I/t characteristics (700 & 900 V)

CH 10 - Fuse-links



General characteristics

Rated voltage	900V a.c./d.c. L/R=2ms
Breaking capacity	50kA a.c./8kA d.c.
Standards	IEC 60269-4
Characteristic	gR

CH 10

Size	I_n [A]	Code No. "standard contacts"	Code No. "type SU contacts"	Pre-arcing Joule integral [A ² s] L/R=2ms	Operating Joule integral [A ² s] L/R=2ms	Power dissipation [0,7 x I _n] P _d [W]	Power dissipation [I _n] P _d [W]	Weight [g]	Packaging [pcs]
10 x 38	2	002625027	002625310	1,2	1,89	0,44	1,10	10/12	10/500 SU:10/380
	4	002625028	002625311	7,6	37	0,55	1,30		
	6	002625029	002625312	14	81	0,73	1,70		
	8	002625030	002625313	30	126	0,70	1,62		
	10	002625031	002625314	20	94	0,98	2,44		
	12	002625032	002625315	48	157	0,82	1,85		
	16	002625033	002625316	97	234	1,06	2,61		
	20	002625034	002625317	164	387	1,27	3,00		
	25	002625035	002625318	246	558	1,61	4,00		



Type SU Contacts



Standard Contacts

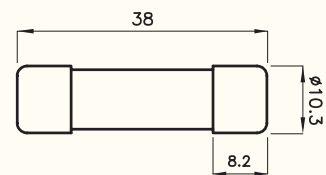
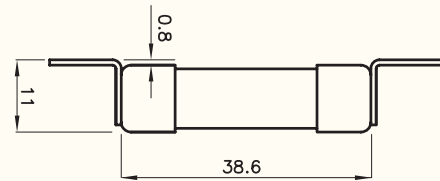
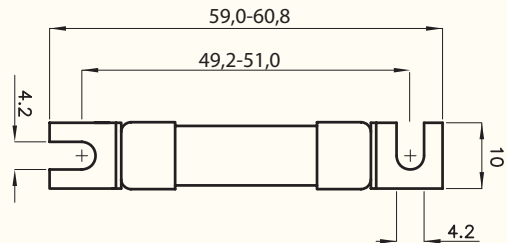

CH 10x85 - Fuse-links

General characteristics

Rated voltage	1200V d.c. L/R=2ms
Breaking capacity	30kA d.c.
Standards	IEC 60269-4
Characteristic	gR



CH 10x85

Size	I_n [A]	Code No. "standard contacts"	Code No. "type SU contacts"	Pre-arcing Joule integral [A ² s] L/R=1ms	Operating Joule integral [A ² s] L/R=1ms	Power dissipation [0,7 x I _n ²] P _d [W]	Power dissipation [I _n ²] P _d [W]	Weight [g]	Packaging [pcs]
10 x 85	2	002625220	002625230	1,6	1,7	1,13	2,74	15/17	10/210 SU:10/160
	4	002625221	002625231	12,5	13	1,19	2,96		
	6	002625222	002625232	21	28	1,33	3,20		
	8	002625223	002625233	22	61	1,60	4,19		
	10	002625224	002625234	53	91	1,63	4,20		
	12	002625225	002625235	41	63	1,31	3,47		
	16	002625226	002625236	141	177	1,57	3,65		
	20	002625227	002625237	212	314	1,68	3,85		
	25	002625228	002625238	273	438	2,17	5,00		

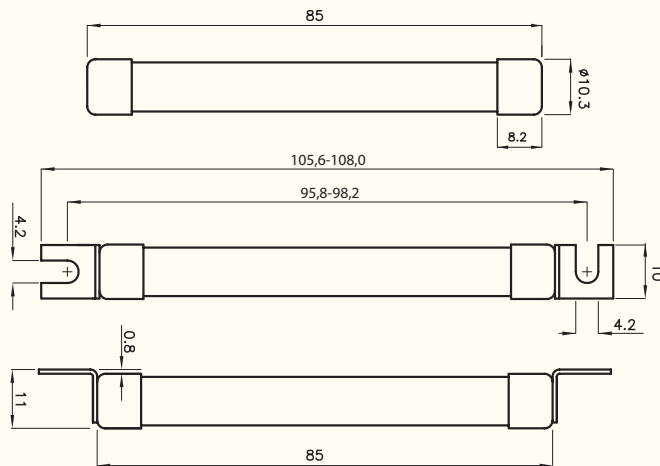

Standard Contacts

Type SU Contacts

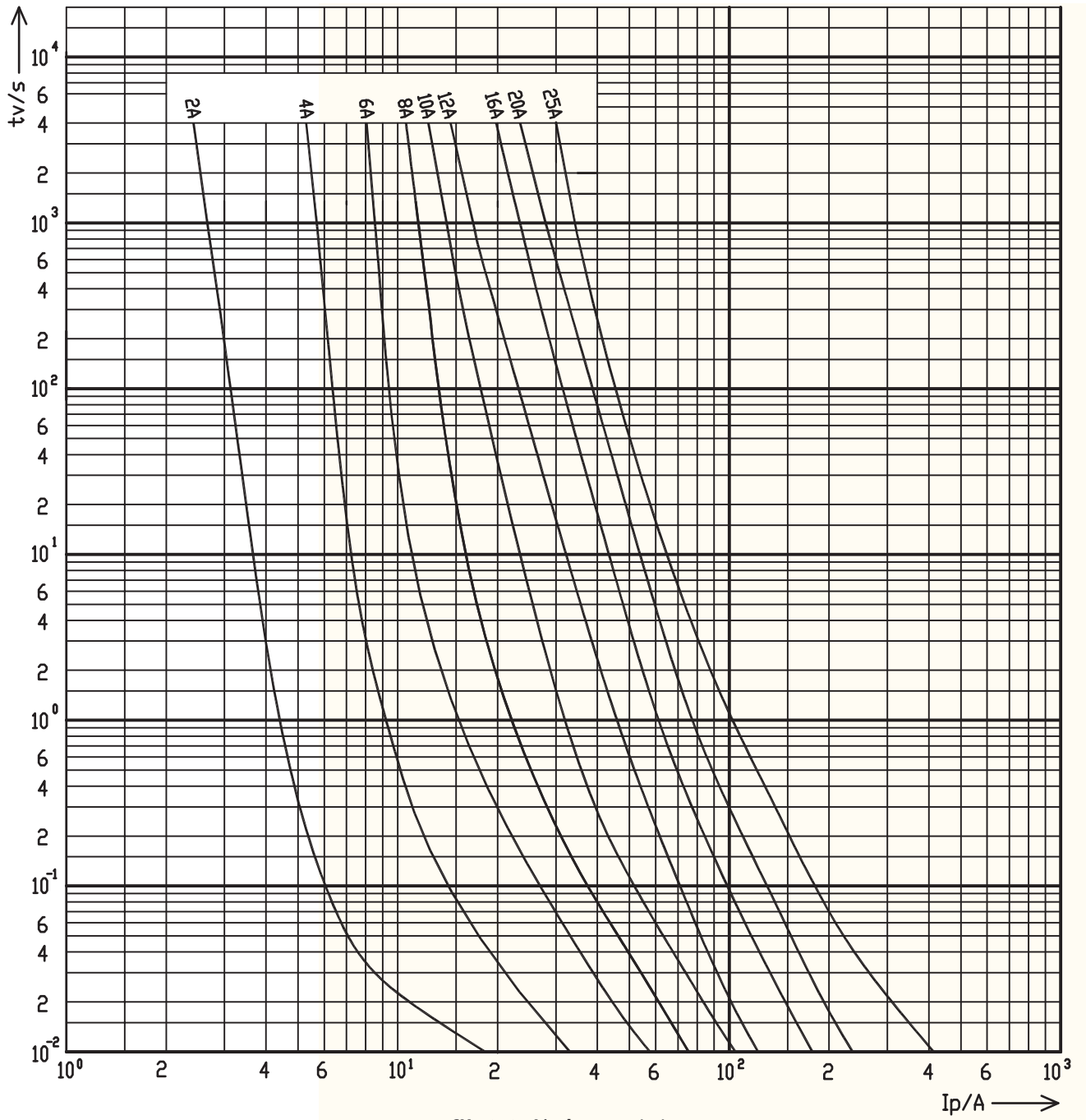

Tamb (°C)	A1
-20	1,179
-10	1,140
0	1,100
10	1,057
20	1,014
30	0,968
40	0,919
50	0,869
60	0,815
70	0,757
80	0,694

