

NV Strip type fuse-switch-disconnector sizes 00, 1, 2, 3

Technical data of NV strip type fuse-switch-disconnectors (in accordance with IEC/EN 60947-3)											
Technical Specifications			SL00/100			SL00/185			SL1		
Electrical Characteristics											
Rated operational voltage	U_e	V	500 AC	690 AC	400 AC	500 AC	690 AC	400 AC	500 AC	690 AC	400 AC
Rated operational current	I_e	A	160	100	160	160	160	160	250	250	250
Rated frequency	-	Hz	40-60	40-60	40-60	40-60	40-60	40-60	40-60	40-60	40-60
Rated insulation voltage	U_i	V	AC 800						AC 1000		
Total power loss at I_{th} (without fuse)	P_v	W	18			23					
Utilization category	-	-	AC22B	AC22B	AC22B	AC23B	AC22B	AC23B	AC22B	AC22B	AC23B
Fuse links											
Size - DIN 43 620, IEC 60269-2	-	-	000/00						1		
Max. rated current (gG)	I_n	A	160	100	160	160	160	160	250	250	250
Max. permissible power loss per fuse link	P_v	W	12						32		
Dimensions											
Mass	-	kg	100 mm = 1,40			185mm=2,4			4,9		
Busbars (distance)	-	mm	100			185			185		
Cable connection											
Screw	-	-	M8			M10			M10		
Torque	M_a	Nm	12-15			30-35			30-35		
V-clip	-	mm ²	10-95			25-300			25-300		
Torque	M_a	Nm	15			32			32		
Protection											
Operational state	-	-	IP30			IP30			IP30		
Cover open	-	-	IP10			IP10			IP10		
Operating conditions											
Ambient temperature	T_u	°C	-25 ... +55						-25 ... +55		
Operating condition	-	-	Continuous operation								
Mounting	-	-	vertical, horizontal								
Altitude	-	m	≤ 2000								
Pollution degree	-	-	3								
Overvoltage category	-	-	III			IV					

Technical data of NV strip type fuse-switch-disconnectors (in accordance with IEC/EN 60947-3)

Technical Specifications			SL1H			SL2		
Electrical Characteristics								
Rated operational voltage	U_e	V	500 AC	690 AC	400 AC	500 AC	690 AC	400 AC
Rated operational current	I_e	A	250			400	400	400
Rated frequency	-	Hz	40-60			40-60	40-60	40-60
Rated insulation voltage	U_i	V	AC 1000					
Total power loss at I_n (without fuse)	P_v	W	29			54		
Utilization category	-	-	AC22B	AC21B	AC23B	AC22B	AC21B	AC23B
Fuse links								
Size - DIN 43 620, IEC 60269-2	-	-	1			2		
Max. rated current (gG)	I_n	A	250			400	400	400
Max. permissible power loss per fuse link	P_v	W	23			45		
Dimensions								
Mass	-	kg				4,9		
Busbars (distance)	-	mm				185		
Cable connection								
Screw	-	-	M10			M12		
Torque	M_a	Nm	30-35			35-40		
V-clip	-	mm ²	25-240 / 25-300			25-300		
Torque	M_a	Nm				32		
Protection								
Operational state	-	-				IP30		
Front cover open	-	-				IP10		
Operating conditions								
Ambient temperature	T_u	°C	-25 ... +55					
Operating condition	-	-	Continuous operation					
Mounting	-	-	vertical, horizontal					
Altitude	-	m	≤ 2000					
Pollution degree	-	-	3					
Overvoltage category	-	-	IV					

Technical data of NV strip type fuse-switch-disconnectors (in accordance with IEC/EN 60947-3)

Technical Specifications			SL2H			SL3		
Electrical Characteristics								
Rated operational voltage	U_e	V	500 AC	690 AC	400 AC	500 AC	690 AC	400 AC
Rated operational current	I_e	A	400			630	630	630
Rated frequency	-	Hz	40-60			40-60	40-60	40-60
Rated insulation voltage	U_i	V	AC 1000					
Total power loss at I_n (without fuse)	P_v	W	73			115		
Utilization category	-	-	AC22B	AC21B	AC23B	AC22B	AC21B	AC23B
Fuse links								
Size - DIN 43 620, IEC 60269-2	-	-	2			3		
Max. rated current (gG)	I_n	A	400			630	630	630
Max. permissible power loss per fuse link	P_v	W	34			48		
Dimensions								
Mass	-	kg	4,9			5,6		
Busbars (distance)	-	mm				185		
Cable connection								
Screw	-	-	M12			M12		
Torque	M_a	Nm	35-40			35-40		
V-clip	-	mm ²	25-240 / 25-300			25-300		
Torque	M_a	Nm				32		
Protection								
Operational state	-	-				IP30		
Front cover open	-	-				IP10		
Operating conditions								
Ambient temperature	T_u	°C	-25 ... +55					
Operating condition	-	-	Continuous operation					
Mounting	-	-	vertical, horizontal					
Altitude	-	m	≤ 2000					
Pollution degree	-	-	3					
Overvoltage category	-	-	IV					

Technical data

Dimensional overview of NV strip type fuse-switch-disconnectors

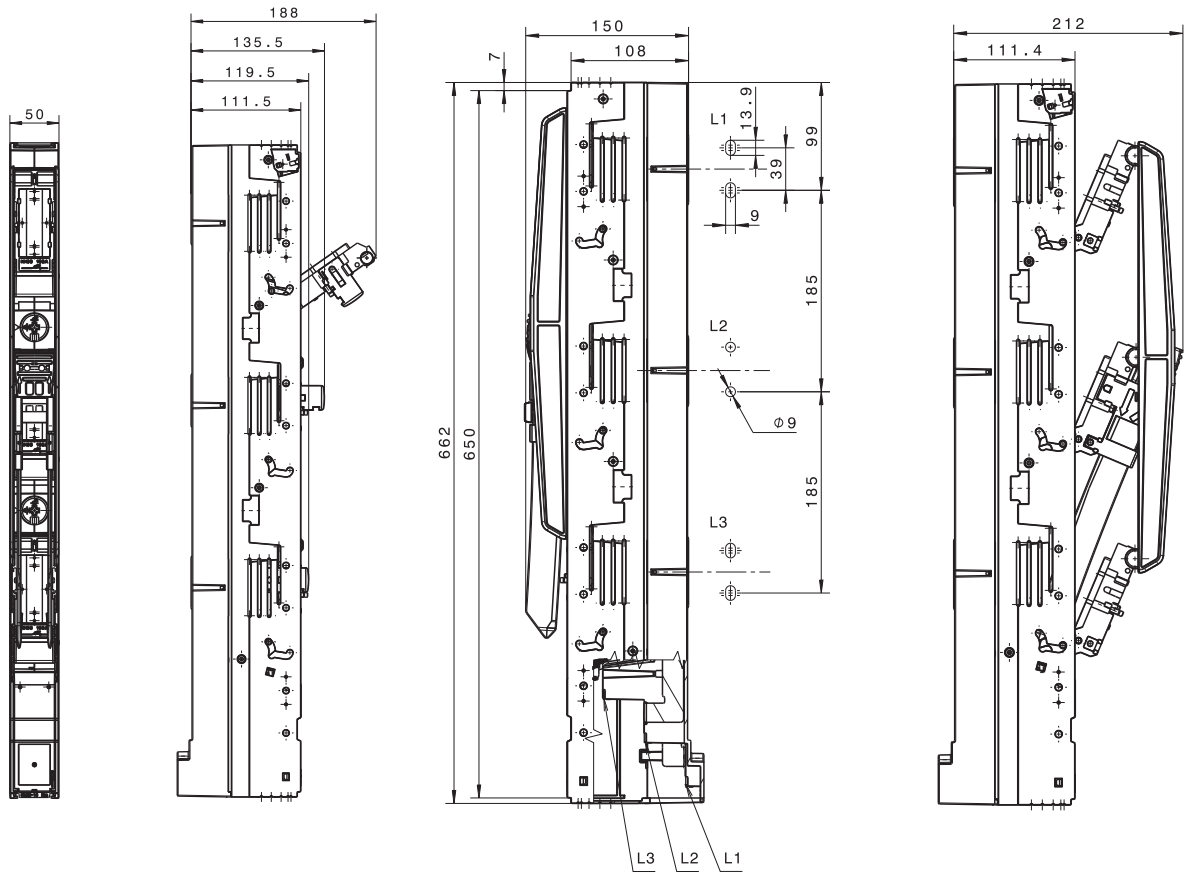
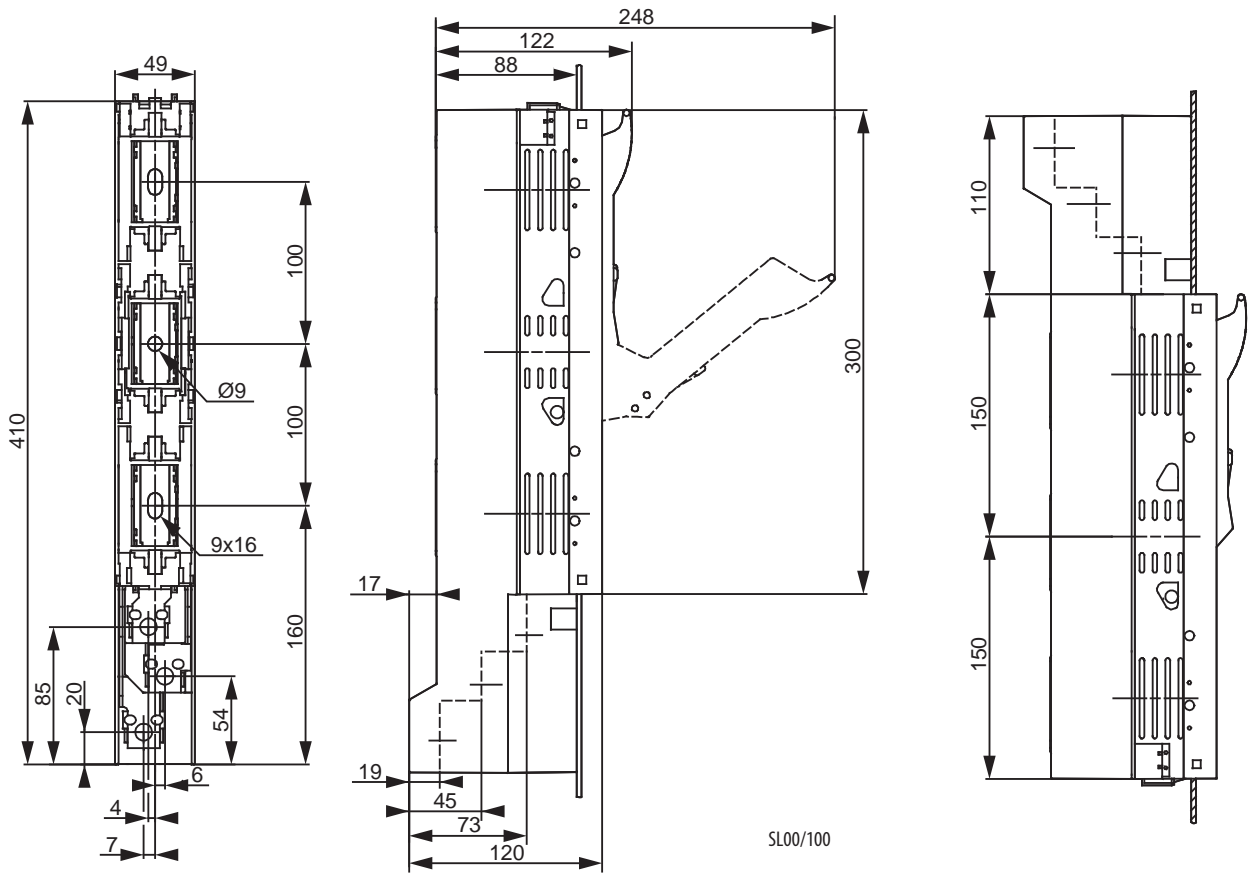

SL00/185

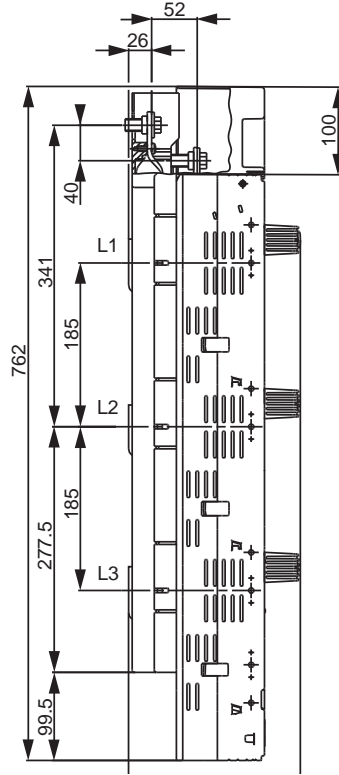
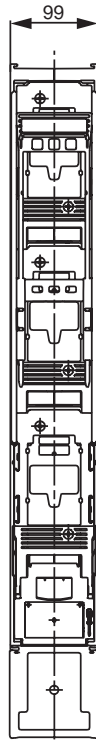
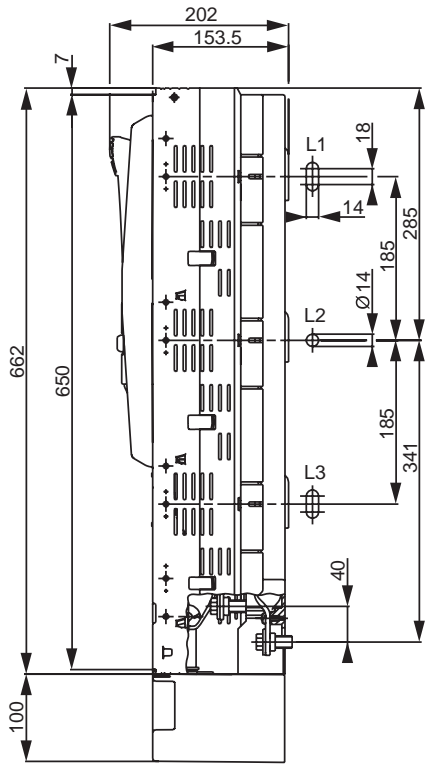

SL1(H), SL2(H), SL3

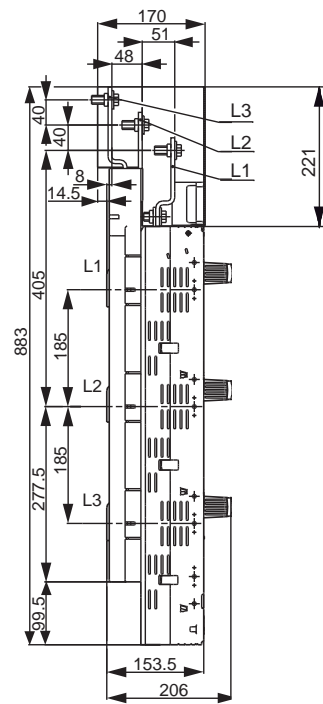
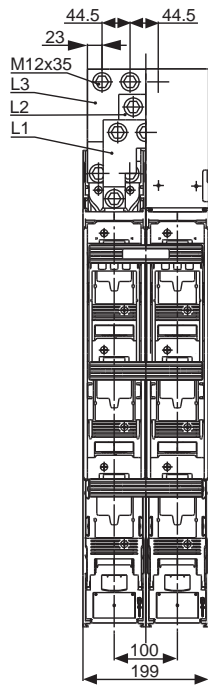
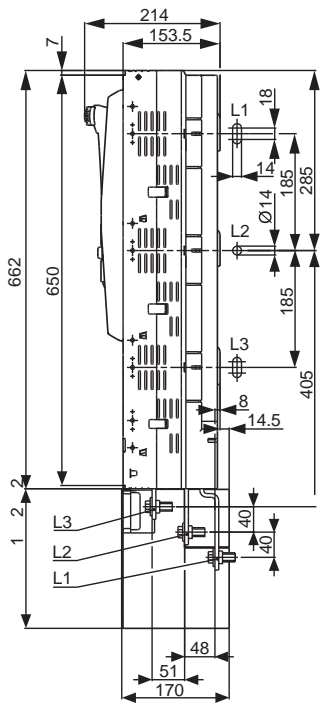

SL3 DOUBLE

Technical data

Dimensional overview of accessories for NV strip type fuse-switch-disconnectors

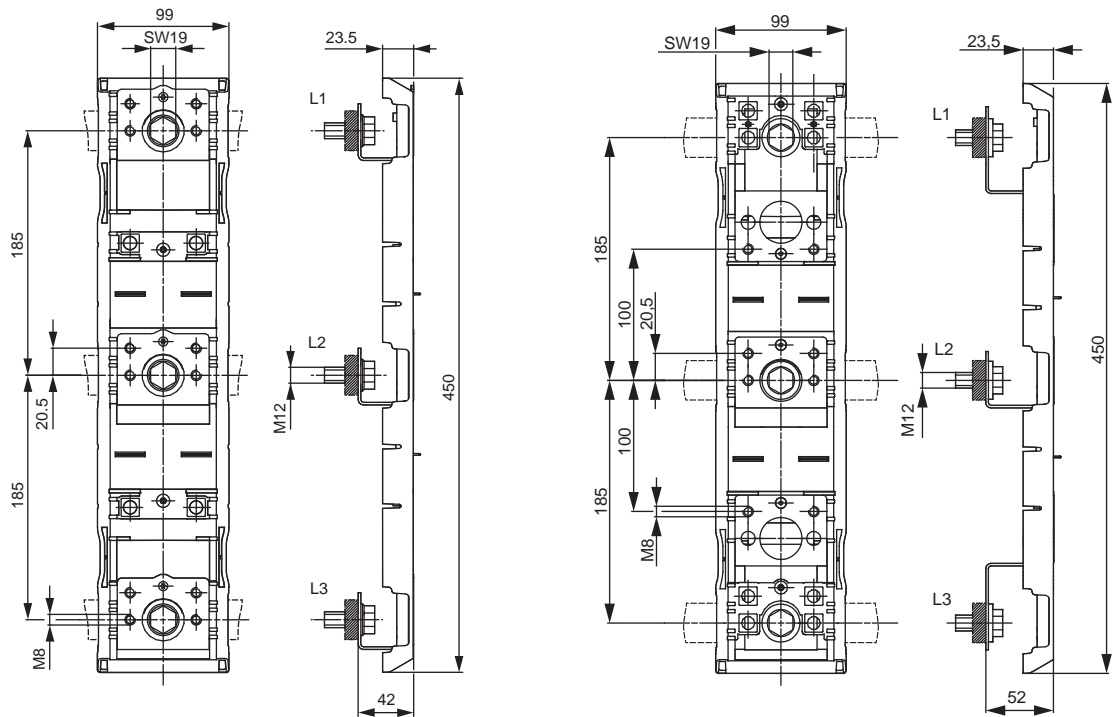

adapter DA 185-185/42

adapter DA 185-100/52

Strip type fuse-switch disconnectors type SL00 EK

Technical data		SL00/100 EK		
Type				
Conventional free air thermal current (I _{th})	A	160		
Rated insulation voltage	V	AC690		
Rated withstand impulse voltage	Kv	6		
Rated frequency	Hz	50 (40-60)		
Rated operational (making and breaking) voltage	V	400V	500V	690 V
Utilization category/Rated operational (making and breaking) current	AC21-B	160A	160A	125A
Utilization category/Rated operational (making and breaking) current	AC22-B	160A	160A	100A
Rated conditional short-circuit current	kA _{eff}	63		
Mechanical durability (operating cycles)		1400		
Electrical durability (operating cycles)		200		
Power dissipation (without fuse-links)	W	19,5		
Degree of protection (cover closed)		IP30		
Degree of protection (cover opened)		IP20		
Pollution degree		3		
Permissible ambient temperature**	°C	-25°C ... +55°C		
Storage temperature	°C	-30°C ... +70°C		
Weight (without fuse-links)	kg	1,2		
Package	pcs	1		

** with ambient temperature between 40-45°C, reduce I_{th} by 5%; with ambient temperature above 45°C, reduce I_{th} by 10%

Dimensions

