

Navodila za uporabo

Operating Instructions

14742f

CE **NH-NV stikalne letve, velikost 00 za 185 mm busbar sistem;**
1-polna in 3-polna



NH strip-type fuse-switch-disconnector size 00 for 185mm
busbar systems 1- and 3-pole switchable

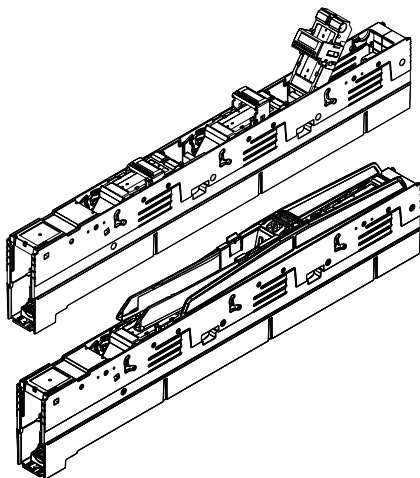

(SLO) Nasvet

Z NV/NH varovalnimi stikali je dovoljeno rokovati le elektrotehnično pooblaščenim osebam po standardu IEC/EN 50110-1.

(EN) Advice

Working with NH fuse handles is only allowed for electrically instructed or skilled persons according to IEC/EN 50110-1.



(SLO) Nasvet

NV/NH varovalke pod bremenom se lahko vstavijo ali izvlečejo le ob uporabi ročaja z rokavico in zaščitnim vizirjem za zaščito obraza (po DIN VDE 0105-100, odstavek 7.4.1).

(EN) Advice

Current-carrying fuse-links are only allowed to be inserted or extracted by using a NH fuse-handle with sleeve and wearing an additional face shield (s. also DIN VDE 0105-100, clause 7.4.1).

1) Odstranitev zgornjega dela stikalne letve
Removing of upper section of disconnecter



Odstrani zgornji del le, če nimate talilnih vložkov v stikalni letvi! *Remove upper section only without fuse-links!*



2) Odklop
Switch-off



Zaprtje/Odprtje
 Hitro!
 On/Off:
 Move lever quickly!

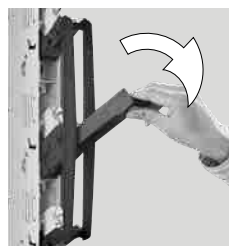
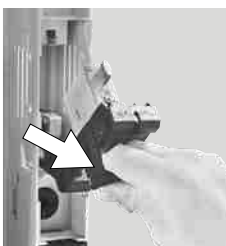

3) 1-polna verzija
1-pole version

4) 3-polna verzija
3-pole version

5) Vstavev talilnega vložka
Insert of fuse-links

6) Odstranitev talilnega vložka
Remove of fuse-link

7) Pozicija odstranitve talilnega vložka 3-polna verzija
Fuse-remove position 3-pole version

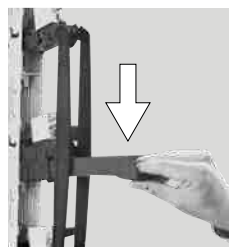
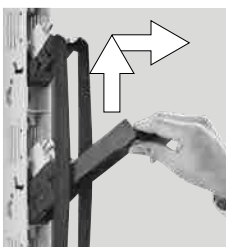
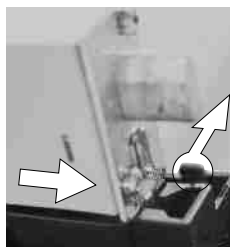

8) Park pozicija 3-polna stikalna
Park position 3-pole switchable

9) Zaklep ločilnika
Locking

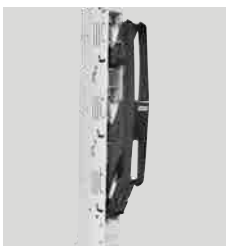
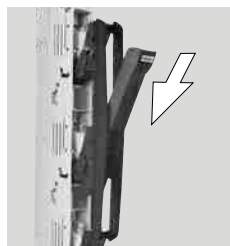
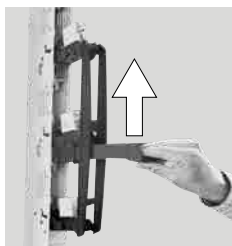

10) Zložljiv ročaj, obrnitev 1-pola Retractable handle 1-pole switching

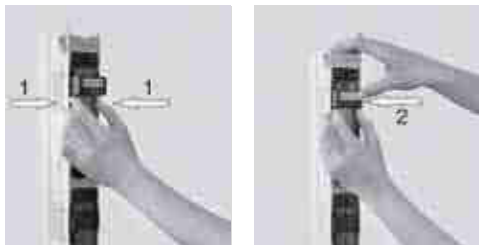

11) Zbiralni sistem Busbar terminal



Debelina zbiralk 5-10 mm, 6 Nm
Busbar thickness 5-10mm 6Nm

12) Priklp zgoraj Connection top

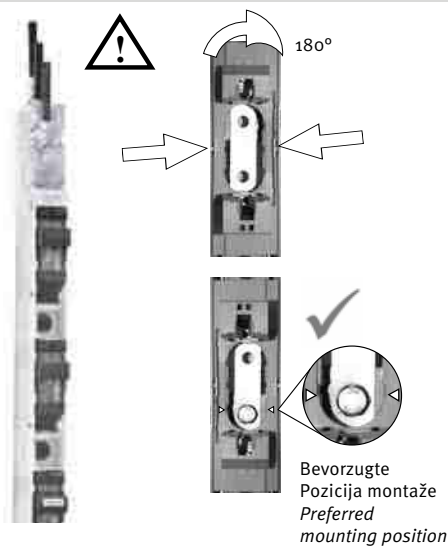

* Priklp aluminijevih vodnikov:

Mehansko odstrani izolacijo na koncu vodnika tik pred priključitvijo, ter namaži z mazivom za boljšo prevodnost.

* Connection of aluminum conductors:

Remove mechanically the oxide coating at the conductor ends immediately before connection and treat with acid-and alkali-free grease.

13) Priklp spodaj Connection bottom

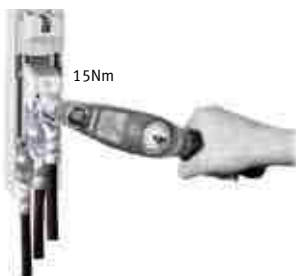
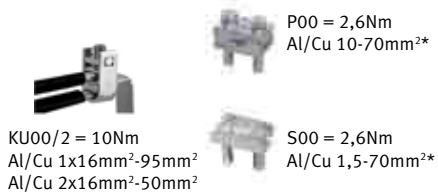
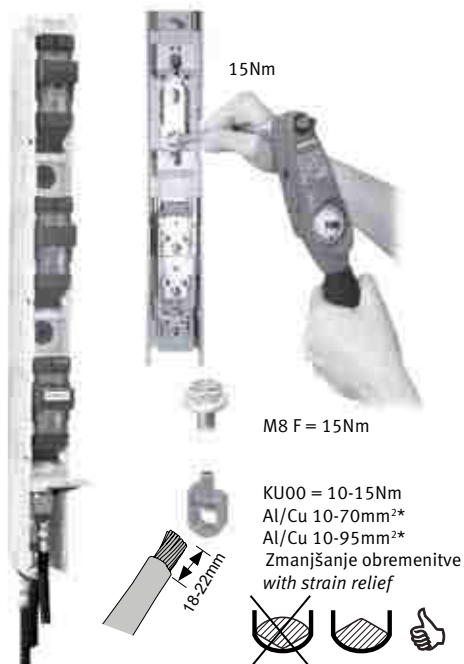

14) Pozicija mikro stikala
switch position indicator



15) Park pozicija 1-pol
Park position 1-pole



16) Montaža z busbar-zbiralčnim adapterjem
Mounting on busbar adapter

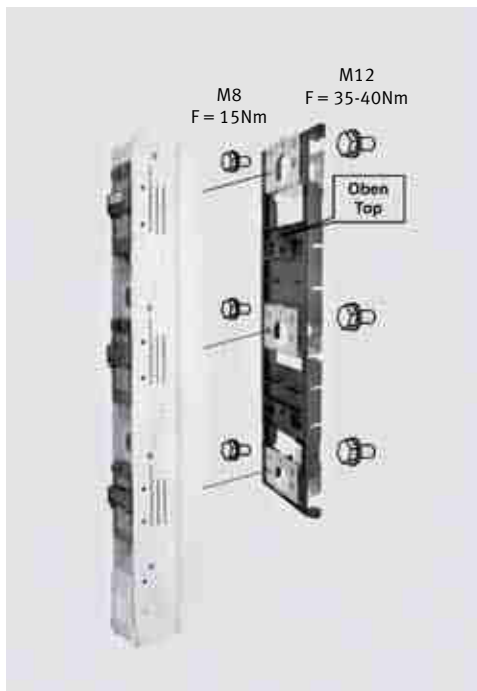

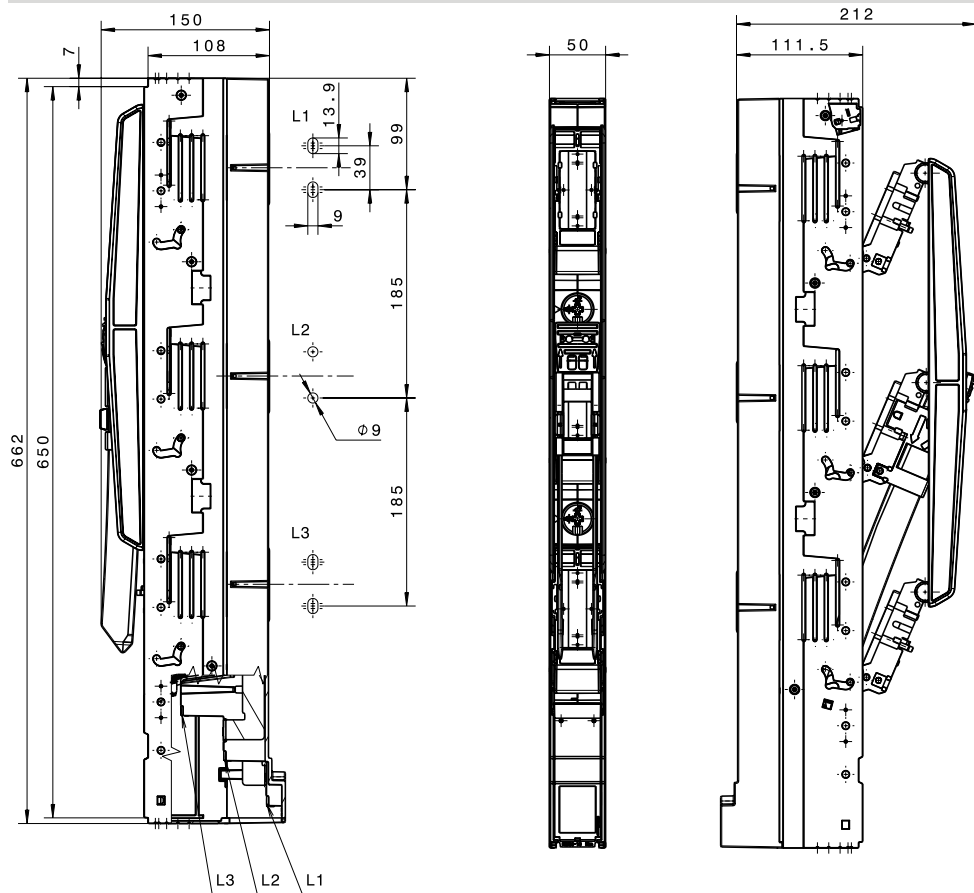
17) Dimenzije
Dimensions

NL

Montage instructie

**Mespatroonlastscheiderstrook NH-00
voor 185mm railsysteem
één- en driepolig schakelbaar**

	Waarschuwing!
	Gevaarlijke elektrische spanning! Dit kan leiden tot elektrische schokken en verbrandingen. Voor het begin van de werkzaamheden de installatie spanningsloos schakelen.



Alleen mespatronen gebruiken met verzilverde messen resp. verzilverde scheidingsmessen!

- 1) Demontage bovendeel mespatroonlastscheiderstrook
Bovendeel enkel te verwijderen zonder geplaatste mespatronen (scheidingsmessen)
- 2) Uitschakelen
In- en uitschakelen: snel schakelen
- 3) Individueel eenpolig schakelbare uitvoering
- 4) Driepolig schakelbare uitvoering
- 5) Plaatsen mespatroon in schakelkap
- 6) Verwijderen mespatroon uit schakelkap
- 7) Verwijderen mespatroon uit schakelkap driepolig schakelbare uitvoering
- 8) Parkeermogelijkheid driepolig schakelbare uitvoering
- 9) Hangslotvergendeling
- 10) Handgreep schakelkap eenpolig schakelbare uitvoering uitklapbaar
- 11) Ophaakklem type SK
Dikte railsysteem 5-10mm
6Nm
- 12) Aansluiting bovenaan
- 13) Aansluiting onderaan
F = 15Nm
KU00 = 10Nm
Al/Cu 10-70mm²
Al/Cu 10-95mm²
met trekontlasting
P00 = 2,6Nm
Al/Cu 10-70mm²
S00 = 2,6Nm
Cu 1,5-70mm²
- 14) Schakelstand aanduiding
- 15) Parkeermogelijkheid eenpolig schakelbare uitvoering
- 16) Montage op stroomrail adapter Bovenkant
- 17) Afmetingen
- 18) Afmetingen

F

Notice d'installation

**Réglette porte-fusible sectionnable Taille 00
à entraxe 185mm,
à 1- ou 3 pôles commutés**

	Avertissement!
	Tension électrique dangereuse! Ceci peut mener aux chocs et aux combustions électriques. Avant d'effectuer des travaux veuillez à mettre l'installation hors tension.



Utiliser uniquement des fusibles à couteaux ou barrettes de neutre argentés!

- 1) Démontage du capot sectionnable Enlèvement du capot sectionnable seulement sans fusibles montés
- 2) Déclencher
Enclencher et déclencher: tirer d'un coup sec
- 3) Individuellement sectionnable unipolaire
- 4) Trois pôles commutés
- 5) Mise en place du fusible dans la coiffe porte-fusible
- 6) Enlèvement du fusible de la coiffe porte-fusible
- 7) Enlèvement du fusible de la coiffe porte-fusible à trois pôles commutés
- 8) Position de mise en attente de la coiffe porte-fusible à trois pôles commutés (Parqué)
- 9) Dispositif à cadenas
- 10) Poignée escamotable coiffe porte-fusible sectionnable unipolaire
- 11) Etrier de serrage SK
Epaisseur barres de cuivre 5-10mm
6Nm
- 12) Raccordement par le haut
- 13) Raccordement par le bas
F = 15Nm
KU00 = 10Nm
Al/Cu 10-70mm²
Al/Cu 10-95mm²
avec décharge de traction
P00 = 2,6Nm
Al/Cu 10-70mm²
S00 = 2,6Nm
Cu 1,5-70mm²
- 14) Contact auxiliaire de précoupure et de position
- 15) Position de mise en attente de la coiffe porte-fusible sectionnable unipolaire (Parqué)
- 16) Montage sur adaptateur jeux de barres Top
- 17) Dimensions
- 18) Dimensions

E**SE****Manual de instrucciones**

Bases Portafusibles
NH tripolares verticales T.00
para embarrados de 185mm

	Atención!
	Riesgo de descargas eléctricas y quemaduras. Desconectar antes de cualquier manipulación.

Installations anvisning

**Säkringslastbrytare storlek 00, avsedda för samlings-
 skensystem med c/c 185mm. 1- och 3 polig manövrering.**

	Varning
	Livsfarlig spänning kan orsaka elchock och brännskador. Koppla ifrån spänningen före arbete på denna utrustning.



**Usar solo cartuchos fusible o cuchillas de
 seccionamiento con los contactos plateados!**



**Använd endast säkringar och kopplingsknivar
 med silverpläterade kontaktytor!**

- 1) Desmontar la parte superior de seccionamiento.

Retirar la parte superior de seccionamiento
 sin los cartuchos fusibles.

- 2) Desconexión

On/Off: Mover la manecilla rapidamente.

- 3) 1-polo (versión unipolar).
 4) 3-polos (version tripolar).
 5) Insertar los cartuchos fusibles.
 6) Retirada del cartucho fusible.
 7) Retirada del cartucho fusible en versión 3 polos.
 8) Posición de parking en el desconectador de 3 polos.
 9) Bloqueo por candado.
 10) Retracción maneta de 1 polo
 11) Embarrado de connexion.

Busbar thickness 5-10mm 6Nm
 Espesor barras 5-10mm 6Nm.

- 12) Conexión superior.
 13) connexion inferior.
 14) Interruptor indicador de posición.
 15) Posición de parking manecilla 1 polo
 16) Montaje del adaptador de embarrados.
 17) Dimensiones
 18) Dimensiones

Sujeto a modificaciones técnicas

- 1) Ta bort den övre delen på säkringslastbrytaren.
 2) Frånslag.
 3) 1-polig version.
 4) 3-polig version.
 5) Montage av säkring.
 6) Demontage av säkring.
 7) Position för demontering av säkring, 3-polig version.
 8) Parkeringsposition, 3-polig version.
 9) Låsning av apparat.
 10) Infällbart handtag, 1-polig version.
 11) Krok för upphängning på samlings-skena. Tjocklek
 5-10mm.
 12) Anslutning uppifrån.
 13) Anslutning nedifrån
 KU00 = 10-15Nm
 Al/Cu 10-70mm²*
 Al/Cu 10-95mm²*
 Med dragavlastning
 P00 = 2,6Nm
 Al/Cu 10-70mm²*
 S00 = 2,6Nm
 Al/Cu 1,5-70mm²*
 14) Microbrytare för lägesindikering.
 15) Parkeringsläge, 1-polig version.
 16) Montering på adapter.
 17) Mått.
 18) Mått.

*** Anslutning av aluminiumledare:**

Avlägsna oxidbeläggningen på ledarändarna
 omedelbart före anslutning och behandla med syra-och
 alkali-fritt fett.

18) Dimenzije
Dimensions

