

Fuse base PLNV

Description

PLNV fuse bases are used for knife-blade fuse links. PLNV fuse bases are available in sizes 00, 1, 2 and 3. Multipole fuse bases can be made by linking several single-pole bases with dividing partitions. Our offer also includes sockets for connecting the neutral wire and grounding. The main purpose of PLNV fuse bases is installation of NH fuses and circuit protection of equipment from the harmful effects of short circuit and overload. In case of need, instead of NH fuse links NH separators can be installed. PLNV fuse base family is made of plastic.

Fields of use and features

NH fuse bases are intended for use in cases where disconnecting under load is not necessary, just a protection from the harmful effects of short circuit and overload. They are suitable for use in outdoor electrical junction boxes, and public lighting,

security cable branches and branches to protect the distribution of measurement cabinets.

The program PLNV includes fuse bases with sizes from 00 to 3 and is intended for mounting on mounting plate or 35mm mounting rails (size 00 only). Standard offer includes 1-pole and 3-pole version. A wide range of different cable connections, allowing great flexibility in use, is also available. Fuse bases size 00 are also available in additional versions with protective covers (to cover the fuse for achieving a degree of protection IP 20), for the larger sizes are only available covers to protect the connectors. Fuse bases type PLNV meet the requirements of the following standards:

IEC 60947,

IEC 60269,

In fuse bases size 00, NH knife-blade fuse links both size 00 and 000 (00C) can be used, while the other sizes correspond only to one size of NH fuse-link (size 1, 2, 3).

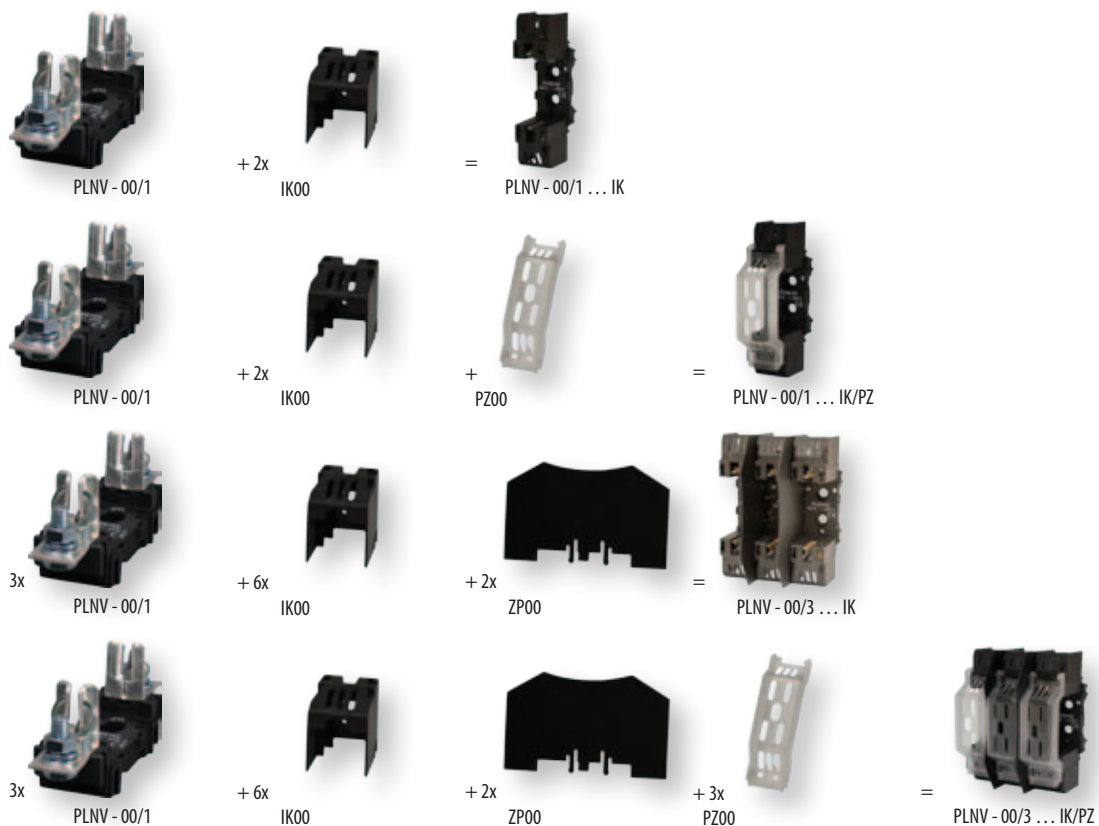

* protective cover for fuse PZ00 is mounted on protective cap IK00

Technical data:

Rated voltage U_n	690 V AC
Rated current I_n	160 A - sizes 00C, 00, 0 250 A - size 1 400 A - size 2 630 A - size 3
Degree of pollution	3 -> IEC 60947, DIN EN 60947, DIN VDE 0110
Standards	IEC 60269, DIN EN 60269, DIN VDE 0636, HRN EN 60269

Fuse Base PLNV

Type	A	B	C	D	E	F	G	H	I	J
2PLNV - 1/1	140	175	200	25	-	-	76	82	-	M10
2PLNV - 2/1	154	200	230	30	-	-	83	87	-	M10
2PLNV - 3/1	154	210	250	30	-	-	91	95	-	M12
2PLNV - 1/3	140	175	200	25	65	187	76	82	103	M10
2PLNV - 2/3	154	200	230	30	65	187	83	87	112	M10
2PLNV - 3/3	154	210	250	30	80	217	91	95	126	M12

Dimensions

PLNV - 00/1

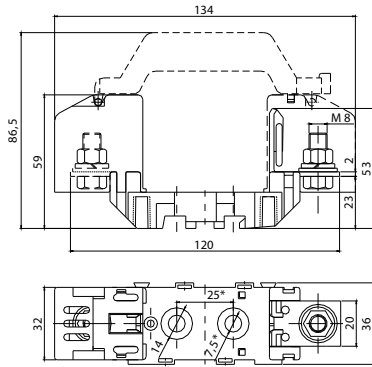

PLNV - 00/3

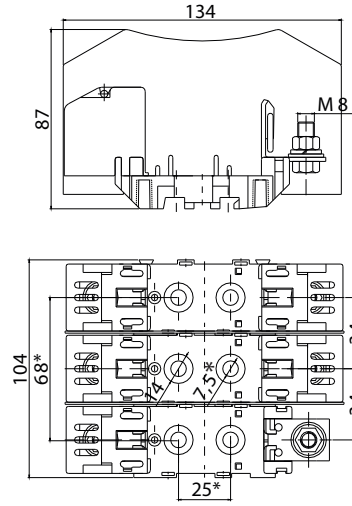

2PLNV - 1,2,3/1

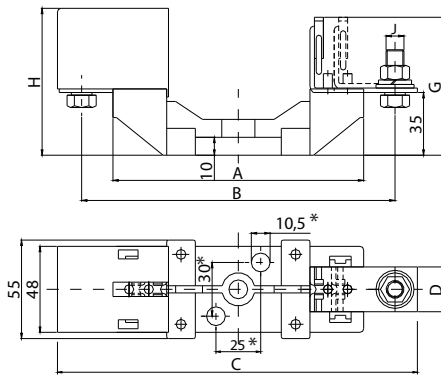

2PLNV - 1,2,3/3

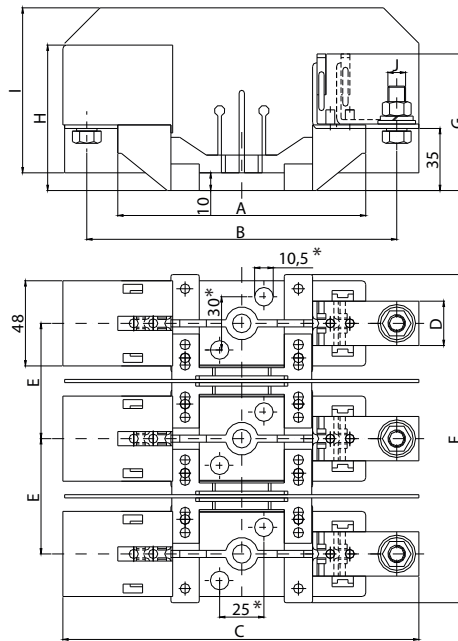



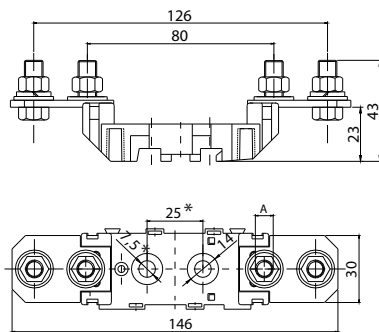















PLNVV - 00C, 00



	A
PLNVV - 000	M8
PLNVV - 00	M10

Type of connections PLNV and PLNS

Type of connection for fuse bases PLNV and PLNS							
Connection	Size	One side of fuse base			Other side of fuse base		
		Description	Type	Drawing	Description	Type	Drawing
A	00	screw	M8		screw	M8	
	1		M10			M10	
	2		M10			M10	
	3		M12			M12	
B	00	clip terminal	OS00		clip terminal	OS00	
	1		OS12			OS12	
	2		OS12			OS12	
C	00	clip terminal	OS00		screw	M8	
	1		OS12			M10	
	2		OS12			M10	
D	00	screw	M8		prism clamp	P00	
	1		M10			P1	
	2		M10			P2	
	3		M12			P3	
E	00	screw	M8		prism clamp	P002*	
	1		M10			P12	
	2		M10			P22	
	3		M12			P32	
F	00	prism clamp	P00		prism clamp	P00	
	1		P1			P1	
	2		P2			P2	
	3		P3			P3	
G	00	prism clamp	P00		prism clamp	P002*	
	1		P1			P12	
	2		P2			P22	
	3		P3			P32	
H	00	prism clamp	P002*		prism clamp	P002*	
	1		P12			P12	
	2		P22			P22	
	3		P32			P32	
K	1	»V« shaped clamp			»V« shaped clamp		
	2						

* IK00 protective cover is only as high as the terminals $2 \times (10-25 \text{ mm}^2 = \text{height of approx. } 25 \text{ mm})$

** interchangeability of the terminals is only possible between type OS... and P... within the same base size. Replacing the terminal with screw M... with the terminal OS... or with terminal P... is not possible.

*** »V« shaped clamp is not interchangeable.

Connections:

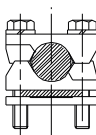

 OS00 6 - 50 mm² - Cu
 OS12 ... 25 - 150 mm² - Cu

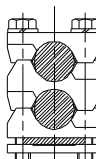
 P00 ... 10 - 70 mm² - Cu / Al
 P1 70 - 150 mm² - Cu / Al
 P2 ... 120 - 240 mm² - Cu / Al
 P3 ... 120 - 300 mm² - Cu / Al

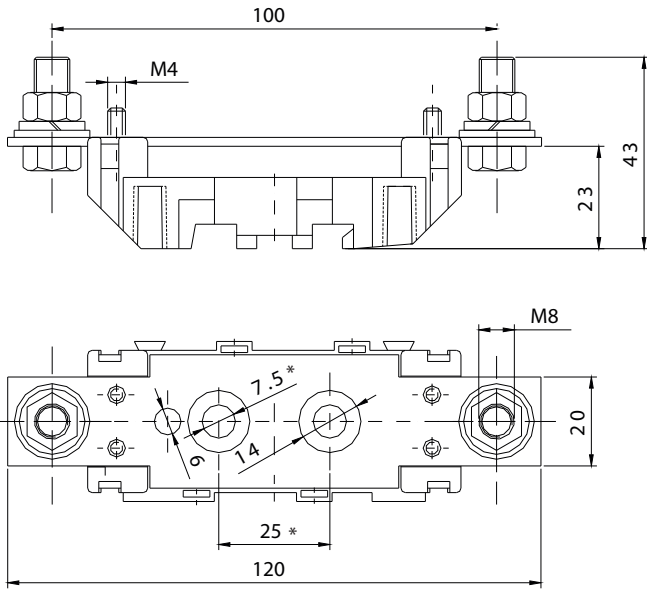

 P002 ... 2 x (10 - 50 mm²) - Cu / Al
 P12 2 x (70 - 95 mm²) - Cu / Al
 P22 ... 2 x (120 - 150 mm²) - Cu / Al
 P32 ... 2 x (120 - 240 mm²) - Cu / Al

Neutral terminal base PLNS

PLNS - 00 N

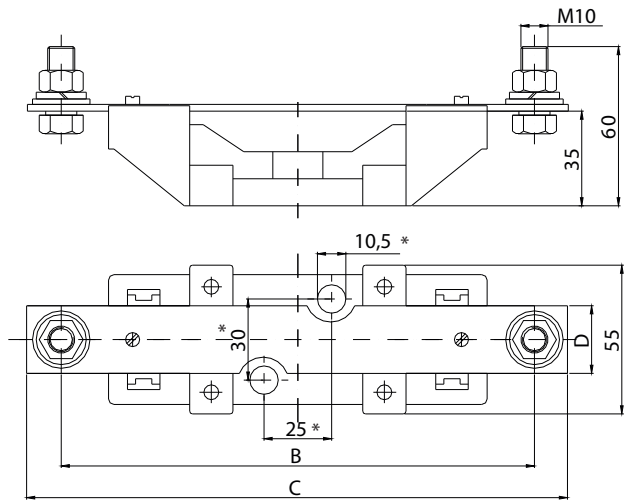

2PLNS - 1,2 N



	2PLNS - 1N	2PLNS - 2N
B	175,6	200
C	200	230
D	25	30

OS 00, OS 12

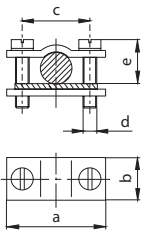

P00, P1, P2, P3

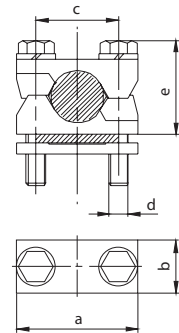

P002, P12, P22, P32

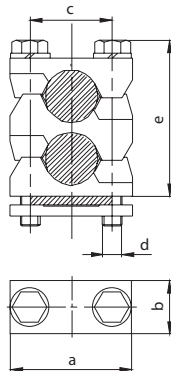

«V» shaped clamp

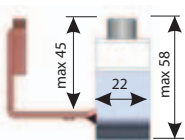

Technical data

Type	a	b	c	d	e _{max}
OS00	24	15	15	M5	15
OS12	36	16	25	M6	25
P00	24	15	15	M5	25
P002	24	15	15	M5	35
P1	37	20	25	M6	30
P12	37	20	25	M6	42
P2	42	22	28	M8	40
P22	42	22	28	M8	55
P3	50	25	30	M8	44
P32	50	25	30	M8	66

Examples:

