

MLBS S / Sd

Motorised Changeover Switch

Instruction Manual

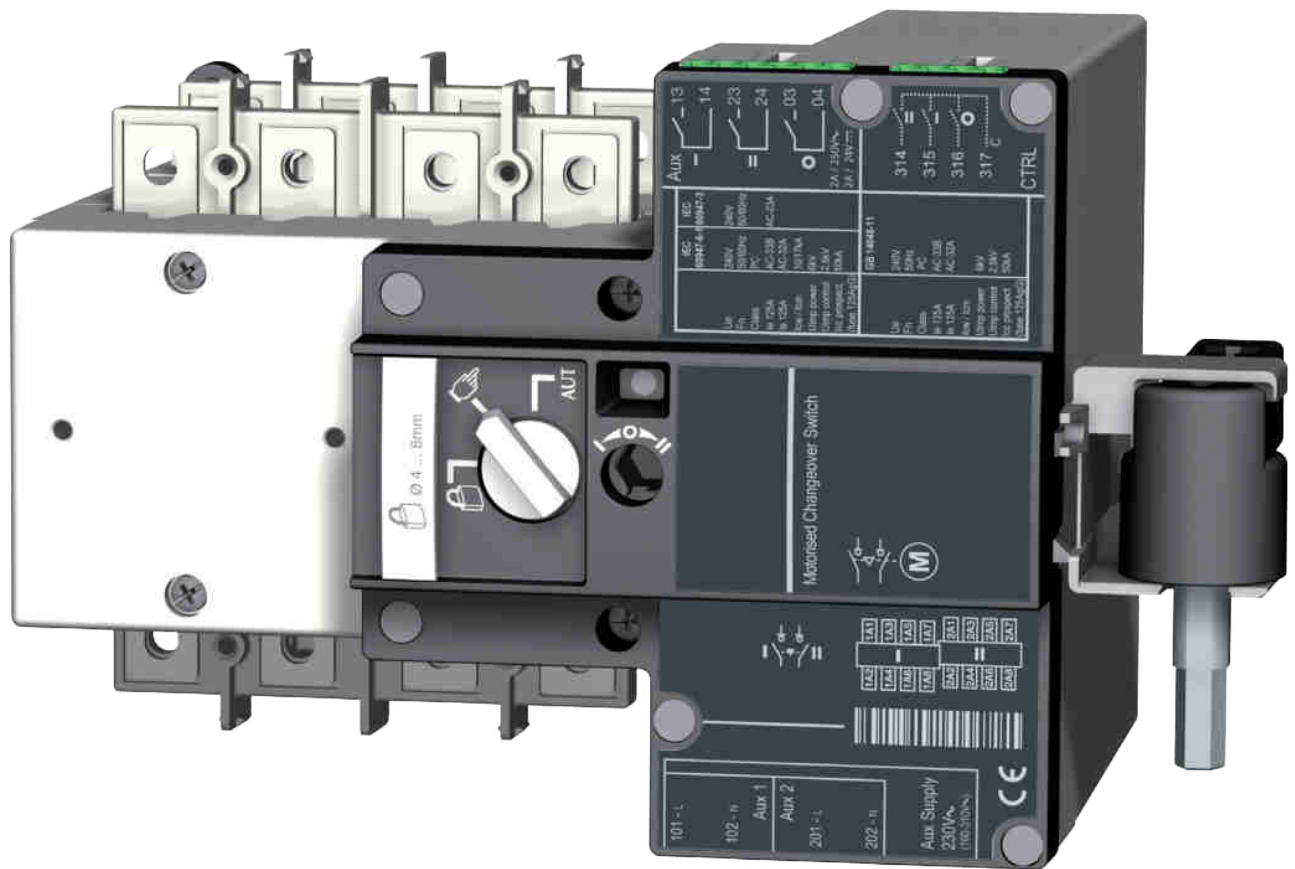



EN



543593A



INDEX

1. GENERAL SAFETY INSTRUCTIONS.....	4
2. INTRODUCTION.....	5
3. THE MLBS FAMILY PRODUCT RANGE.....	6
3.1. THE MLBS BACK TO BACK RANGE KEY FEATURES.....	6
4. QUICK START.....	8
5. GENERAL OVERVIEW.....	10
5.1. MLBS : RTSE « PRODUCT INTRODUCTION ».....	10
5.2. MLBS : RTSE « PRODUCT IDENTIFICATION ».....	11
5.3. MLBS : RTSE « ENVIRONMENTAL DETAILS ».....	12
5.3.1. IP RATING 	12
5.3.2. OPERATING CONDITIONS.....	12
5.3.2.1. TEMPERATURE / CURRENT RATING 	12
5.3.2.2. TEMPERATURE / CONTROL VOLTAGE LIMITS.....	12
5.3.2.3. HYGROMETRY 	12
5.3.2.4. ALTITUDE 	12
5.3.3. STORAGE CONDITION.....	13
5.3.3.1. TEMPERATURE.....	13
5.3.3.2. STORAGE DURATION PERIOD.....	13
5.3.3.3. STORAGE POSITION.....	13
5.3.4. VOLUME AND SHIPPING WEIGHTS :.....	13
5.3.5. CE MARKING.....	13
5.3.6. LEAD FREE PROCESS.....	13
5.3.7. WEEE.....	14
5.3.8. EMC STANDARD.....	14
6. INSTALLATION.....	15
6.1. MLBS : RTSE « PRODUCT DIMENSIONS ».....	15
6.2. ATYS : RTSE « MOUNTING ORIENTATION ».....	15
6.3. ATYS : RTSE « ASSEMBLY OF CUSTOMER MOUNTED ACCESSORIES ».....	16
6.3.1. BRIDGING BAR INSTALLATION.....	16
6.3.2. TERMINAL SHROUDS.....	17
6.3.2.1. OUTGOING TERMINAL SHROUDS (WHEN USING BRIDGING BARS).....	17
6.3.2.2. INCOMING TERMINAL SHROUDS.....	18
6.3.2.3. SEALING FACILITY FOR ADDED SECURITY.....	18
6.3.3. DIRECT HANDLE AND STORAGE CLIP.....	19

7. CONNECTIONS	20
7.1. POWER CIRCUITS	20
7.1.1. CABLE CONNECTIONS	20
7.1.2. POWER CONNECTION TERMINALS	20
7.1.3. POWER CONNECTION SECTIONAL AREA	20
7.2. CONTROL CIRCUITS	21
7.2.1. TYPICAL MLBS WIRING DIAGRAMS	21
7.2.1.1. MLBS : 230VAC	21
7.2.1.2. MLBS : 12VDC	21
7.2.1.3. EXTERNAL POWER SUPPLY (400VAC)	22
7.2.2. MLBS RTSE + ATS CONTROLLERS TYPE ATYS C30 AND ATYS C40	22
7.2.3. MLBS INPUT AND OUTPUT CONTACTS	23
7.2.4. TERMINAL DENOMINATION, DESCRIPTION AND CHARACTERISTICS	23
8. ATYS OPERATING MODES	24
8.1. AUTO MODE : ELECTRICAL OPERATION	25
8.1.1. POWER SUPPLY	25
8.1.2. COMMAND INPUTS - DESCRIPTION	25
8.1.3. COMMAND INPUTS - TECHNICAL DATA	26
8.1.4. COMMAND INPUTS - CONTROL LOGIC	26
8.1.5. DRY CONTACT OUTPUTS – AUXILIARY	26
8.2. EMERGENCY MANUAL OPERATION	27
8.3. PADLOCKING	27
9. MLBS CHARACTERISTICS	28
10. TROUBLE SHOOTING GUIDE	29
11. SPARES AND ACCESSORIES	30
11.1. ACCESSORIES	30
12. MLBS ORDERING INFORMATION	30
12.1. MLBS CATALOGUE REFERENCE NUMBERS	30

1. GENERAL SAFETY INSTRUCTIONS

- This manual provides instructions on safety, connections and operation of the **MLBS** motorised changeover switches manufactured by SOCOMEC.
- Whether the **MLBS** are sold as a loose product, as a spare, as an enclosed solution or as any other configuration, these devices must always be installed and commissioned by qualified and experienced personnel, in line with the manufacturers recommendations, following good engineering practices and after having read and understood the details in the latest release of the relative product instruction manual.
- Maintenance on the product and any other associated equipment including but not limited to servicing operations must be performed by adequately trained and qualified personnel.
- Each product is shipped with a label or other form of marking including rating and other important specific product information. One must also refer to and respect markings on the product prior to installation and commissioning for values and limits specific to that product.
- Using the product outside the intended scope, outside ETI recommendations or outside the specified ratings and limits can cause personal injury and/or damage to equipment.
- This instruction manual must be made accessible so as to be easily available to anyone who may need to read it in relation with the **MLBS**.
- The **MLBS** meet the European Directives governing this type of product and includes CE marking on each product.
- No covers on the **MLBS** should be opened (with or without voltage) as there may still be dangerous voltages inside the product such as those from external circuits.
- **Do not handle any control or power cables connected to the **MLBS** when voltage may be present on the product directly through the mains or indirectly through external circuits.**
- Voltages associated with this product may cause injury, electric shock, burns or death. Prior to carry out any maintenance or other work on live parts or other parts in the vicinity of exposed live parts, ensure that the switch including all control and associated circuits are de-energized.

 DANGER	 WARNING	 CAUTION
RISK : Electric shock, burns, death	RISK : Possible personal injury	RISK : Equipment damage

- As a minimum the **MLBS** comply with the following international standards:
 - IEC 60947-6-1
 - GB 14048-11
 - EN 60947-6-1
 - BS EN 60947-6-1
 - NBN EN 60947-6-1
 - IEC 60947-3
 - IS 13947-3
 - EN 60947-3
 - NBN EN 60947-3
 - BS EN 60947-3

The information provided in this instruction manual is subject to change without notice, remains for general information only and is non-contractual.

2. INTRODUCTION

MLBS family of “remotely operated transfer switching equipment” (RTSE) are designed for use in power systems for the safe transfer of a load supply between a normal and an alternate source. The changeover is done in open transition and with minimum supply interruption during transfer ensuring full compliance with IEC 60947-6-1, GB 14048-11 and other international TSE standards as listed.

The MLBS are full load break (switch type) derived transfer switching equipment where the main components are proven technology devices also fulfilling requirements in IEC 60947-3 standards.

As Class PC RTSE, the MLBS products are capable of “making and withstanding short circuit currents” assigned to IEC 60947-3 utilization categories of up to AC23B, GB 14048-11, IEC 60947-6-1 and equivalent standards with utilization categories of up to AC32B.

MLBS motorised source changeover switches ensure:

- Power Control and Safety between a normal and an alternate source.
- A complete product delivered as a fully assembled and tested solution.
- Intuitive HMI for emergency / local operation.
- Integrated and robust switch disconnection.
- Clear switch position indication.
- An inherent failsafe mechanical interlock.
- Stable positions (I – 0 – II) non affected by vibration and shocks.
- Constant pressure on the contacts non affected by network voltage.
- Energy Efficient with virtually no consumption whilst on the normal, alternate or off positions.
- Quick, easy and safe “on-load” dual emergency manual operation.
(Manual operation is functional with and without the motorization in place).
- Extremely rugged, error free and built in padlocking facility.
- Straight forward installation with effective ergonomics.
- Minimal downtime with the possibility to perform easy maintenance.
- Simple and secure motorization controls interface.
- Integrated and independent switch position auxiliary contacts.
- Ample accessories to suite specific requirements.
- Compatibility with virtually any make of ATS, AMF, Genset controller.
(Typically an ATyS C30 / C40 ATS Controller or similar and driven through volt free contacts)
- Power supply continuity for most applications . . .

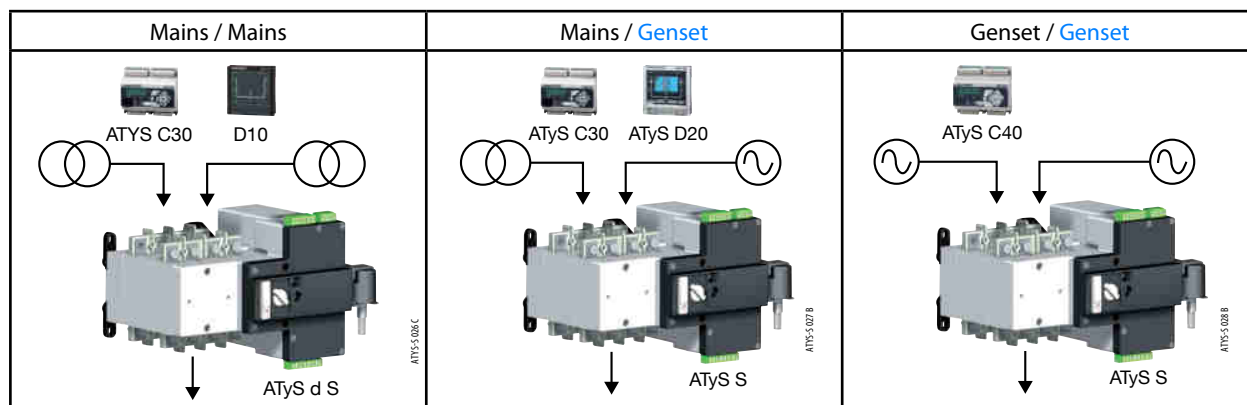

3. THE MLBS FAMILY PRODUCT RANGE

The MLBS family has been engineered together with the SOCOMEC centre of excellence in France who boasts its very own in-house 100MVA instantaneous power test lab accredited by COFRAC and working in partnership with: KEMA, CEPEC, UL, CSA, ASTA, Lloyd's Register of Shipping, Bureau Veritas, BBJ-SEP, EZU, GOST-R, . . . and others.

SOCOME C has been manufacturing power control and safety products since 1922. The first generation SOCOMEC "motorised changeover switches" were introduced in 1990 and today the MLBS brand has become trusted by major players in the power industry worldwide.

The MLBS Family includes a complete range of remotely operated transfer switch equipment (RTSE) as well as automatic fully integrated products and solutions (ATSE). Selecting the right MLBS will depend on the application as well as the nature of installation in which the MLBS will be installed.

This instruction manual includes details and instructions specific to the "MLBS" RTSE only. For all other MLBS Family of products please refer to the specific instruction manual related to that product.

An overview of the complete MLBS range is presented below:
 (The MLBS are the transfer switch equipment detailed in this instruction manual).

Just the right MLBS for your application...

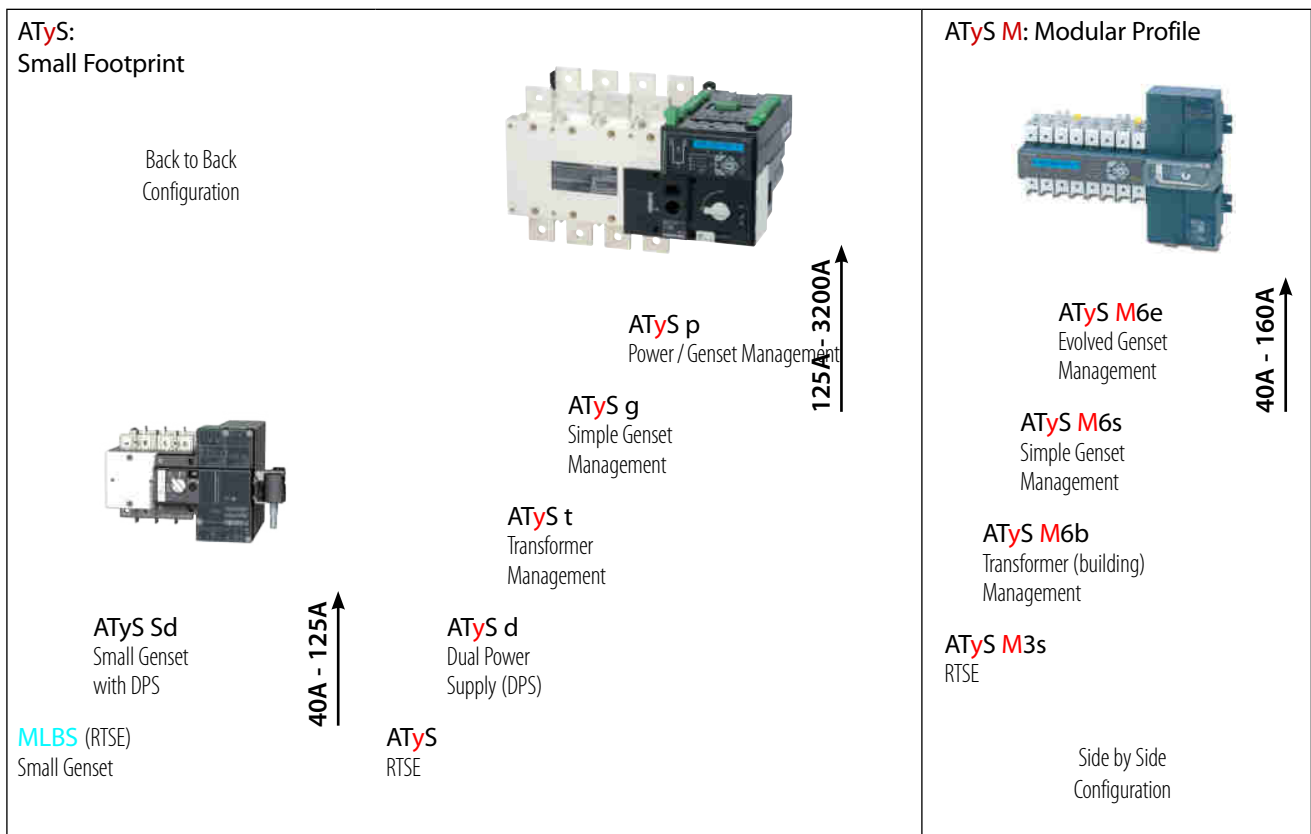

3.1. The MLBS back to back Range Key Features

Selecting the right MLBS will depend on the application, the functionality required as well as the nature of the installation in which the MLBS will be installed. Below is an outline product selection chart listing the key features of each product (back to back configuration) to help to quickly understand and select the right MLBS for your needs.

	MLBS	ATyS Sd	ATyS	ATyS d	ATyS t	ATyS g	ATyS p
Motorised Changeover with control driven by dry contacts	•	•	•	•	•	•	•
Manual Emergency Operation with external handle	•	•	•	•	•	•	•
Wide band AC control voltage supply	•	•	•	•	•	•	•
Wide band DC control voltage supply	•						
Watchdog relay to ensure product availability			•	•	•	•	•
Ratings from 40 – 125A as indicated or 125A – 3200A for •	40 – 125A	40 – 125A	•	•	•	•	•
Override controls and force switch to zero (off) position			•	•	•	•	•
Integrated position auxiliary contacts (I - O - II)	•	•	•	•	•	•	•
Source availability LED display				•	•	•	•
Remote Display module RJ45 connection for ATyS D10				•	•	•	ATyS D20
Integrated Dual Power Supply		•		•	•	•	•
Network - Network Applications	•	•	•	•	•		•
Network - Genset Applications	•	•	•	•		•	•
Genset - Genset Applications	•	•	•	•			
Pre-defined fixed I/O			• 5/1	• 5/1	• 9/2	• 11/3	• 5/2
Programmable I/O							• 6/1
Additional programmable I/O modules (Optional up to 4 modules)							• 8/8
Remotely operated Transfer Switching Equipment (RTSE Class PC)	•	•	•	•			
Automatic Transfer Switching Equipment (ATSE Class PC)					•	•	•
Remote + Manual Control	•	•	•	•			
Auto + Remote + Manual Control					•	•	
Auto + Remote + Local + Manual Control							•
Auto-configuration of voltage and frequency levels					•	•	•
Switch Position LED display					•	•	•
Security Sealing Cover					•	•	
Configuration through potentiometers and dip switches					•	•	
Test on load functionality						•	•
Test off load functionality						•	•
Programmable configuration with keypad and LCD display							•
Metering & Measurement: kW; kVar; kVA + kWh; kVarh; kVAh							•
Communication RS485 + Ethernet + Ethernet gateway (Optional)							•
Websserver Access through optional Ethernet module (Optional)							•
Easy Configuration software (Through Ethernet/Modbus)							•
Remote Terminal Unit RJ45 connection for ATyS D20							•
Data Logger for Event Recording with RTC (Through Ethernet/Modbus)							•
Programmable Engine Exerciser functionality (Through Ethernet/Modbus)							•
Multi level password access							•
Load Shedding function							•
Capacity Management functionality							•
Peak shaving functionality							•
4 - 20mA communication module (Optional)							•
KWh Pulsed output module (Optional)							•
Counters KWh, permutation . . .							•
LCD display for programming, metering, timers and counters							•
Possibility to add optional functionality							•

4. QUICK START



QUICK START EN

ATyS S / Sd

Motorised Source Changeover Switch

Preliminary operations

Check the following upon delivery and after removal of the packaging:

- Packaging and contents are in good condition.
- The product reference corresponds to the order.
- Contents should include:
 - Qty 1 x ATyS S / Sd product
 - Qty 1 x handle and storage clip
 - Quick Start instruction sheet
 - Qty 1 set of 3 terminal connectors
 - Qty 1 set of 16 screws, nuts and washers for connecting the power section.

Warning

⚠ Risk of electrocution, burns or injury to persons and / or damage to equipment.

This Quick Start is intended for personnel trained in the installation and commissioning of this product. For further details refer to the product instruction manual available on the SOCOMEC website.

- This product should always be installed and commissioned by qualified and approved personnel.
- Maintenance and service operations should be performed by trained and authorised personnel.
- Do not handle any control or power cables connected to the product when voltage may be, or may become present on the product, directly through the mains or indirectly through external circuits.
- Always use an appropriate voltage detection device to confirm the absence of voltage.
- Ensure that no metal objects are allowed to fall in the cabinet (risk of electrical arcing).

Failure to observe good engineering practises as well as to follow these safety instructions may expose the user and others to serious injury or death.

⚠ Risk of damage the device

- In case the product is dropped or damaged in any way it is recommended to replace the complete product.

Accessories

- Bridging bars 4P 125A.
- Control voltage transformer 400V -> 230V.
- Terminal Shrouds Supply side / Load side.
- Secure Connector Bracket.
- Voltage taps.
- DIN-rail 4 modules.
- ATS Controller type ATyS C30 + D10/D20.
- ATS Controller type ATyS C40.

For further details refer to the product instruction manual under chapter "Spares and Accessories"

www.socomec.com

To download brochures, catalogues and technical manuals:



Printing informations: 1 color Black. White paper 90g/m².
Printing size: 420x297. Final size 210x148. This page visible first.



Non contractual document.
Subject to change without notice.

Installation and Commissioning

STEP 1 Cabinet / Back Plate Installation

STEP 2 Connecting the POWER Section

STEP 3 COMMAND / CONTROL terminal connections

STEP 4 Power Supply terminal connections

STEP 5 Emergency Handle mounting

STEP 6 Check

STEP 7A Control by an external order (AUTO)

STEP 7B Emergency Manual Operation

STEP 7C Padlocking

STEP 7B Manual Operation

STEP 6 Check

Whilst in manual mode, check the wiring and if ok power up the product.

STEP 7A Automatic Operation

Ensure that the emergency handle is not inserted in the product, and turn the mode selector to the AUT position.

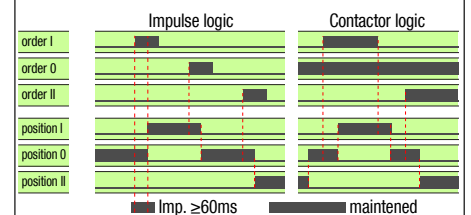

Close the contact corresponding to the desired position.
Order Priority: I and II are equal priority over 0. Should I and II be closed simultaneously the product will not change position.

STEP 7C Padlocking mode (in position 0)



STEP 1 Installation

Attention: Ensure that the product is installed on a flat rigid surface.
Orientation:

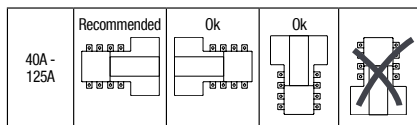

Detailed fixing point: 0° - 45° - 90°

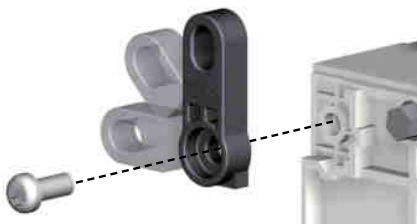

All dimensions in mm.

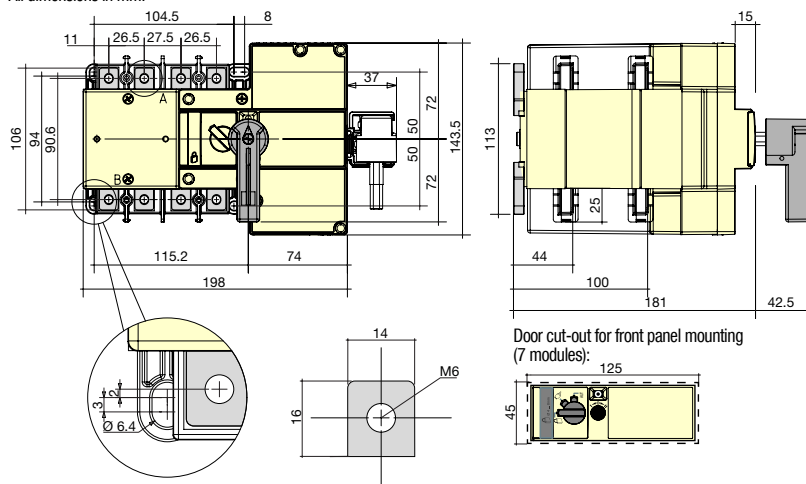

Door cut-out for front panel mounting (7 modules):

STEP 2 Power Terminal Connections

To be connected using terminal lugs, rigid or flexible busbars.

	40 A	63 A	80 A	100 A	125 A
Minimum cable section Cu (mm ²) at lth	10	16	25	35	50
Maximum cable section Cu (mm ²)	70	70	70	70	70
Type of screw	M6	M6	M6	M6	M6
Recommended tightening torque (N.m)	4.5	4.5	4.5	4.5	4.5
Maximum tightening torque (N.m)	5.4	5.4	5.4	5.4	5.4

All values are indicative.

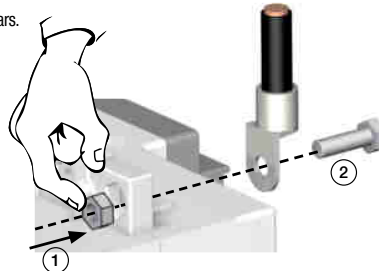

STEP 3 CONTROL / COMMAND Terminals

Ensure that the product is in manual mode and connect the product controls using the supplied connectors and suitable cable of section 1.5 - 2.5 mm².

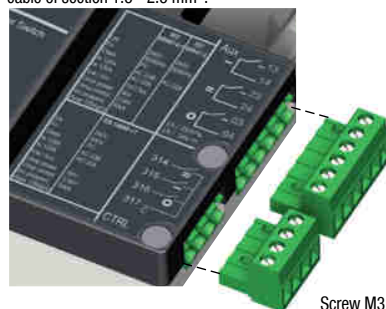

Screw M3
Tightening torque: min.: 0.5 Nm - max.: 0.6 Nm

STEP 5 Handle Storage Assembly

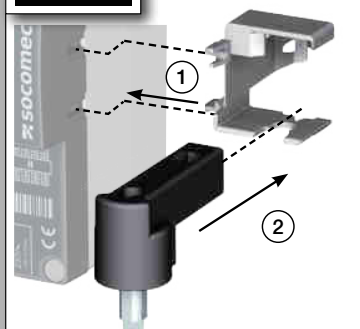

STEP 4 Power Supply Terminals

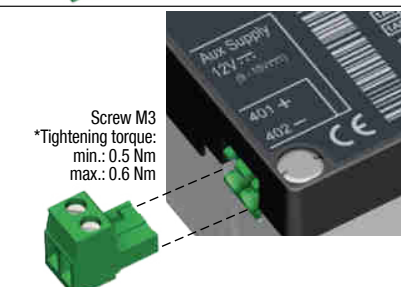
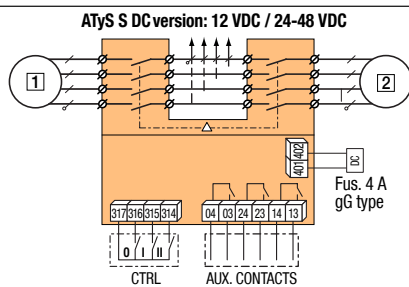
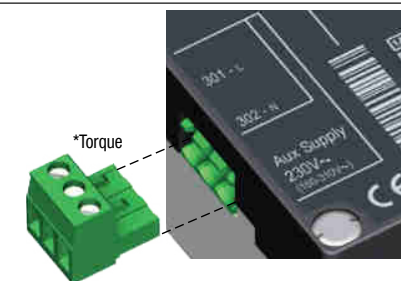
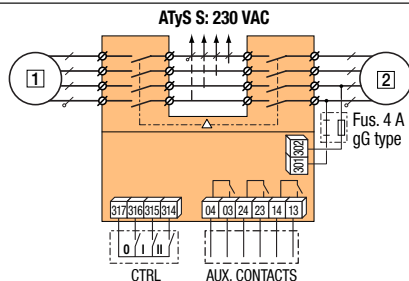
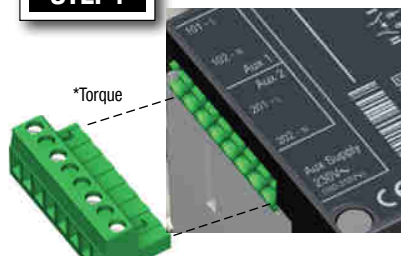
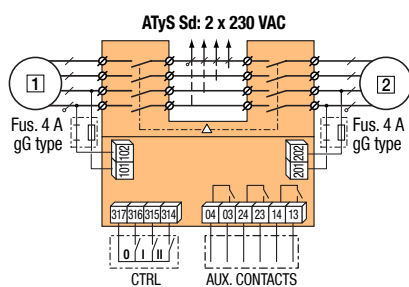

5. GENERAL OVERVIEW

5.1. MLBS : RTSE « Product introduction »

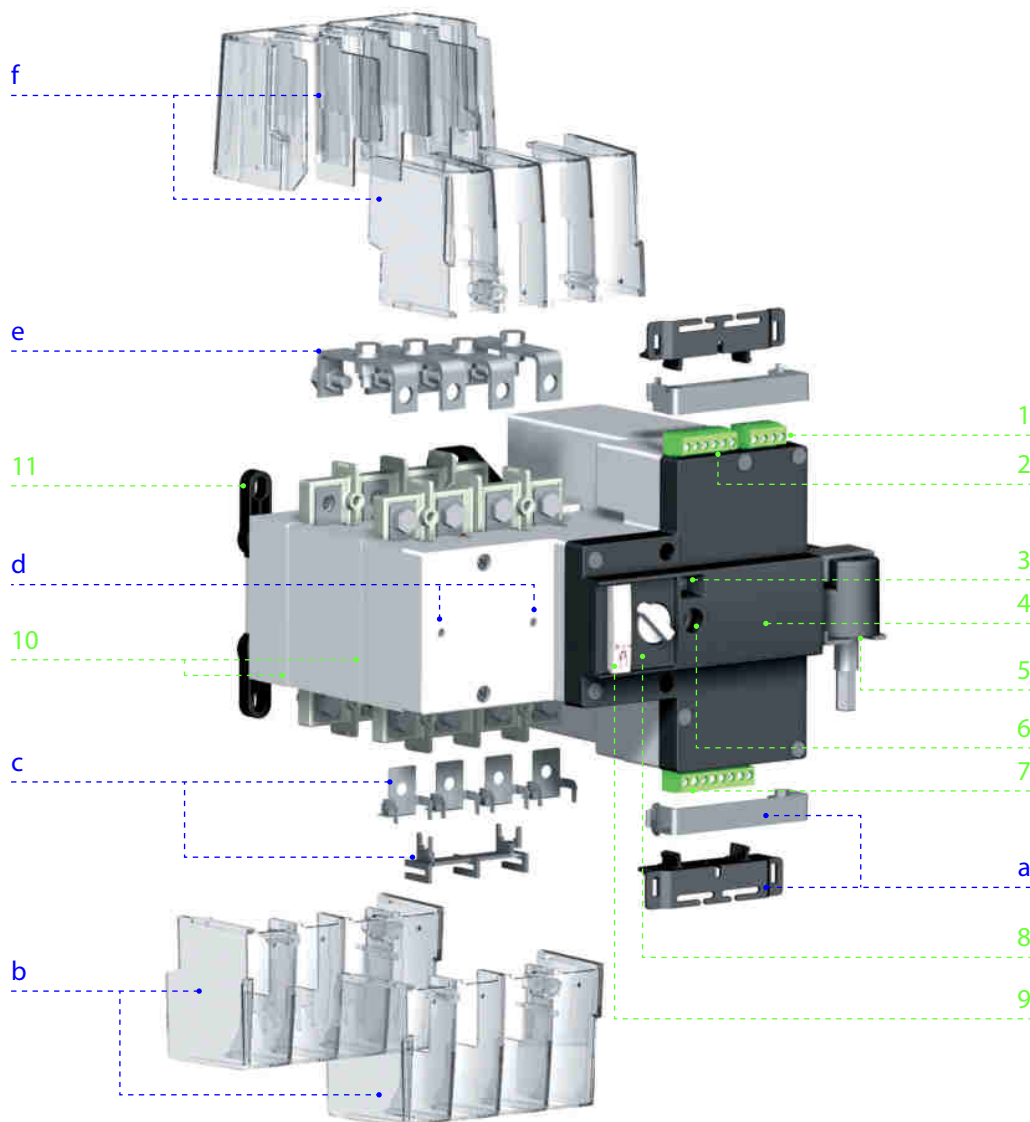

Included as standard:

1. Position Output Aux. Contacts x 3
(Position indication I-O-II outputs: 6 pin connector)
2. Control / Command Input contacts x 3
(Position orders I-O-II : 4 pin connector)
3. Switch position indication window I – 0 – II
I (On) – 0 (Off) – II (On)
4. Motorisation module housing and control unit.
5. Emergency manual operation handle and storage clip.
6. Emergency manual operation shaft location
(Accessible only in manual mode)
7. Auxiliary power supply :
MLBS : 230Vac, 12Vdc, 24/48Vdc
8. Auto / Manual / Padlocking mode selector switch
9. Facility for padlocking in "0" position. (3 x 4-8mm)
10. Power Section : 4P changeover switch assembly
Includes an inherent mechanical interlock.
Back Switch II, Front Switch I).
11. Back-plate mounting MLBS fixing lugs x 4

Available as an accessory:

- a. Easy secure connector bracket
- b. Supply side terminal shrouds
- c. Voltage tapping kit
- d. Mounting holes for the MLBS din rail accessory. (Accepts up to 4 modules)
- e. Reversible top/bottom bridging bars
- f. Load side terminal shrouds

5.2. MLBS : RTSE « Product identification »

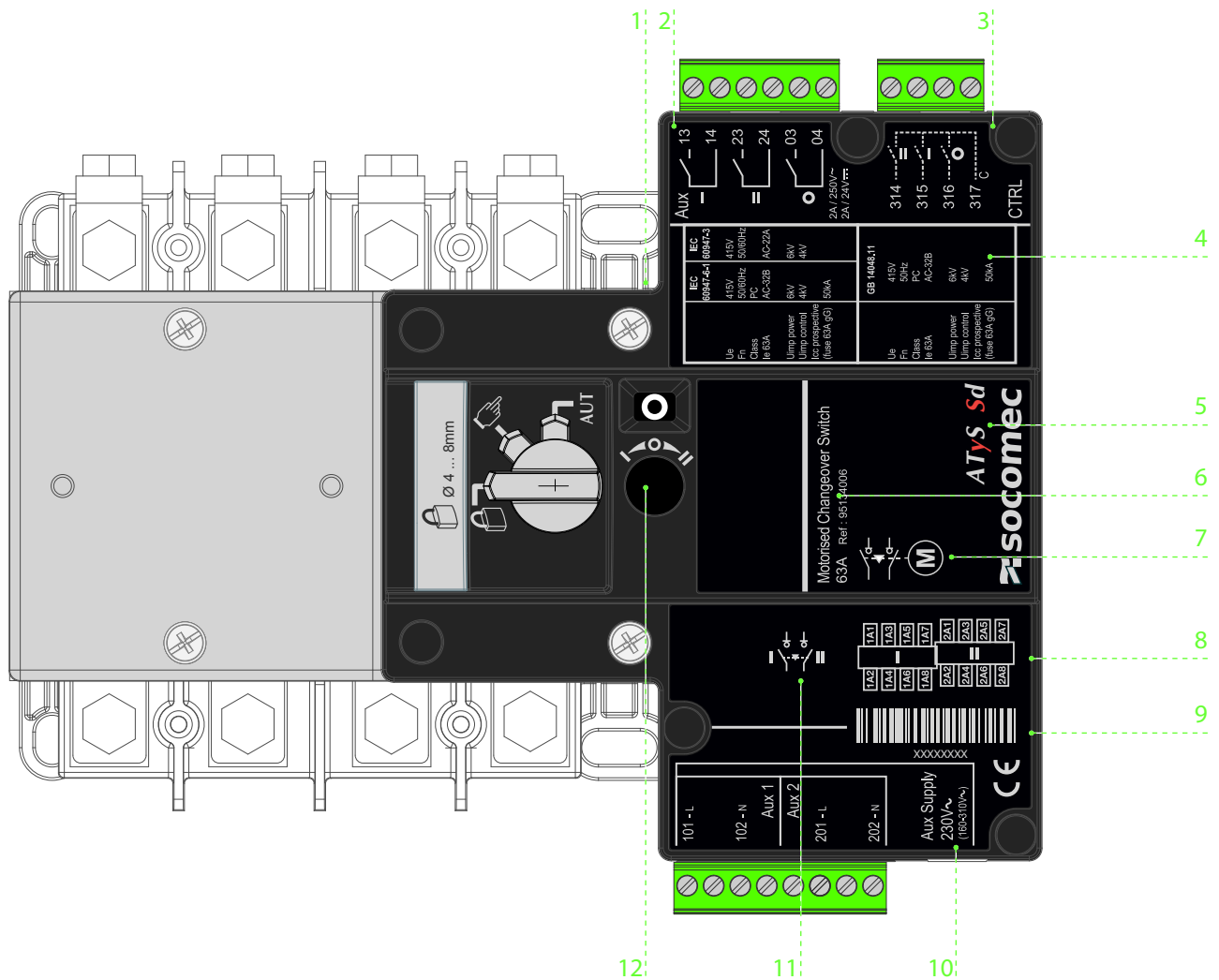

1. Switch 1 (Front) and Switch 2 (back) identification labels (Top & Bottom)
2. Output contacts identification label.
3. Input contacts identification label.
4. Main changeover switch identification label including:
Electrical characteristics & Applicable standards
5. MLBS Product Type
6. MLBS current rating and product reference number
7. Product Type pictogram (RTSE – Motorised Changeover Switch)
8. Power Terminals incoming and outgoing wiring details.
9. Complete MLBS product serial number, barcode and CE marking.
10. Auxiliary power supply contacts and identification label
11. Switch position and mechanical interlock pictogram
12. Direction of rotation for emergency manual operation

5.3. MLBS : RTSE « Environmental details»

As a minimum, the MLBS products meet the following environmental requirements:

5.3.1. IP Rating



- IP2X against direct contact for the motorization control unit.
- IP2X against direct contact for the power section with the connections in place and when including suitable, correctly installed incoming and outgoing terminal shields.
- IP 0 for the bare power section without terminal shields in place.

5.3.2. Operating Conditions

5.3.2.1. Temperature / Current Rating



- From -20 to +40°C without derating
- From -20 to +70°C when applying a Kt derating correction factor

Kt: Correction Factor	Temperature
0.9	40 °C to 50 °C
0.8	50 °C to 60 °C
0.7	60 °C to 70 °C

* Simplified derating method: $I_{thu} \leq I_{th} \times K_f$

* A more precise calculation may be done for specific applications. Should this be required please contact us.

5.3.2.2. Temperature / Control Voltage Limits

Temperature	Voltage (AC)	DC 12V	DC 24/48V
Ambient	154 - 310 V	8.4 - 15.6V	16.8V – 62.4V
-20 °C	165 - 310 V	9V - 15.6V	17.5V – 62.4V
-10 °C	165 - 310 V	9V - 15.6V	17.5V – 62.4V
55 °C	154 - 290V	8.4V - 15V	16.8V – 60V
70 °C	154 - 285V	8.4V - 15V	16.8V – 60V

5.3.2.3. Hygrometry



- 80% humidity without condensation at 55°C
- 95% humidity with condensation at 40°C

5.3.2.4. Altitude



- Up to 2000m in altitude without derating
- For higher altitude the Ka correction factors below apply

Ka: Correction Factor	2000 m < A ≤ 3000 m	3000 m < A ≤ 4000 m
Ue	0.95	0.8
Ie	0.85	0.85

5.3.3. Storage Conditions

5.3.3.1. Temperature

- From -40 to +70°C

5.3.3.2. Storage duration period

- Maximum storage up to a period of 12 months
- (Recommendation: To be stored in dry, non corrosive and non saline atmospheric conditions)

5.3.3.3. Storage position

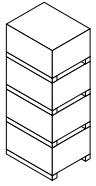

A maximum of 4 boxes may be stocked vertically

5.3.4. Volume and shipping weights :

Rating	MLBS 12Vdc	MLBS 230Vac
63 A	004661650	004661653
100 A	004661651	004661654
125 A	004661652	004661655
Net Weight	3.1 kg	3.15 kg
Gross Weight	3.7 kg	3.85 kg

5.3.5. CE Marking

The MLBS comply with the European directive for :

- The Electromagnetic compatibility no. 2004/108/CE dated 15th of December 2004.
- Low voltage directive no. 2006/95/CE dated 12th of December 2006.

5.3.6. Lead Free Process

- The MLBS comply with the European directive for RoHS.



5.3.7. WEEE

The MLBS are built in accordance with 2002/96/CE directive:

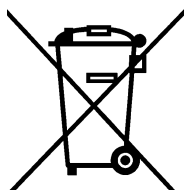

5.3.8. EMC standard

The MLBS are designed and built in accordance with IEC 60947-1 standards

Class B products :

Products intended to be installed in an industrial, commercial or residential environment.

Electrical Fast Transient/Burst (EFT /Burst Test)	12DC Variant - 2kV, Criteria: B 24/48DC Variant - 2kV Criteria: B 240Vac Variant - 2kV Criteria: B applicable to command connector from earth, 1kV
Surge Test	12DC Variant - 2kV, Criteria: B 24/48DC Variant - 2kV Criteria: B 240Vac Variant - 2kV Criteria: B
Impulse Test	4.8 kV 1.2/50us - 0.5 J - IEC 60947-1 criteria A
Electrostatic Discharge (ESD)	DC Variant-4/8 kV, Criteria: B 240Vac Variant - 4/8kV Criteria: B Contact Discharge 4kV, Air Discharge : 8kV
Radiated RF Electromagnetic fields test	Frequency Range : 80-1000MHz 12DC Variant - 10V/m, Criteria: A 24/48DC Variant - 10V/m Criteria: A 240Vac Variant - 10V/m Criteria: A
Conducted disturbances induced by RF Fields	Frequency Range : 0.15-80MHz 12DC Variant - 10V, Criteria: A 24/48DC Variant - 10V Criteria: A 240Vac Variant - 10V Criteria: A
Conducted Emission Test	150 kHz to 30 MHz, Class B
Radiated Emission Test	30 MHz to 1000 MHz, Class B

6. INSTALLATION

6.1. MLBS : RTSE « Product dimensions »

Dimensions 40A to 125A

All dimensions in mm.

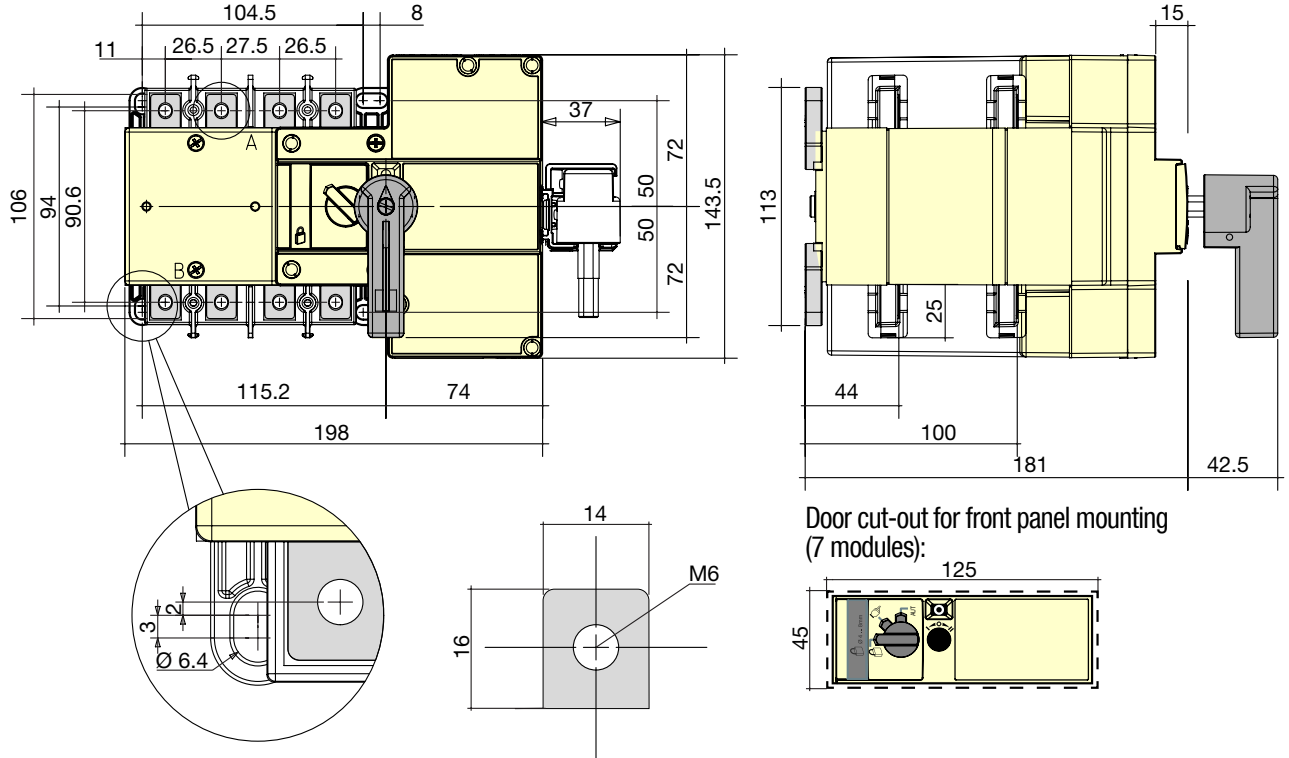

Door cut-out for front panel mounting (7 modules):

 CAUTION	To consider the space required for mounting (storage) of the manual operation handle as well as the wiring.
--	---

6.2. MLBS : RTSE « Mounting Orientation »

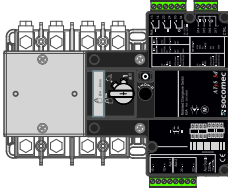
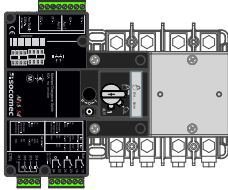
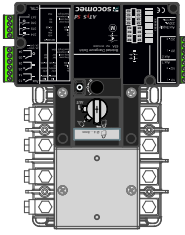
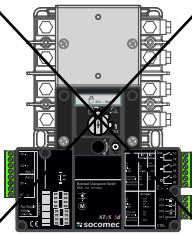
			
40A to 125A	Recommended	OK	OK
			Not OK

 CAUTION	Always install the product on a flat and rigid surface.
--	---

6.3. MLBS : RTSE «Assembly of Customer Mounted Accessories»



DANGER

Never handle any customer mounted accessories while there may be the risk of voltage being or becoming present.

6.3.1. Bridging bar installation

All Ratings : 40A to 125A

Bridging bars are delivered complete (4P copper bars rated at 125A lth) together with associated bolts nuts and washers. For ease of installation onto the MLBS terminals, fixing of bridging bars is recommended to be carried out prior to fixing the unit onto a backplate.

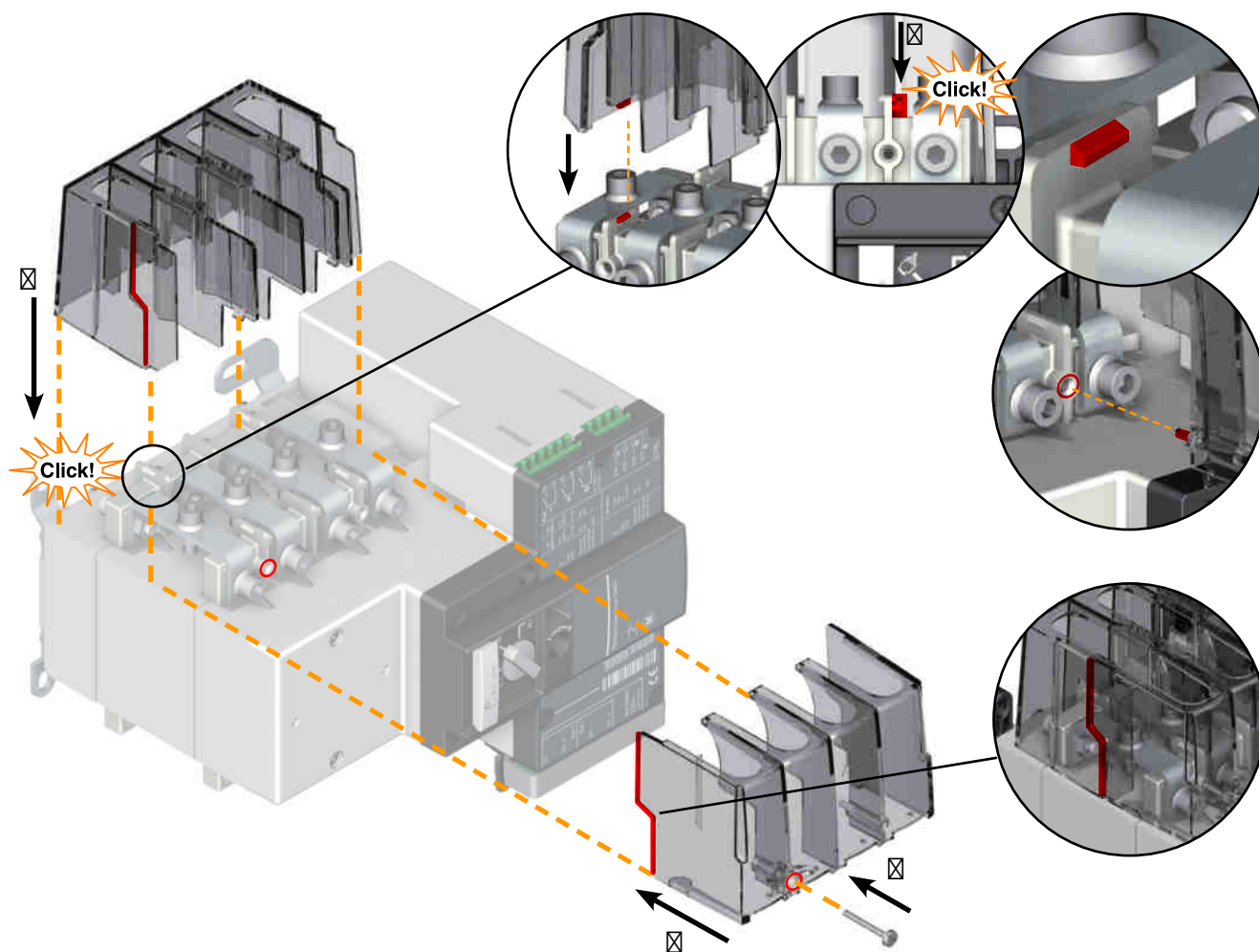

Removing the Outgoing Terminal Shrouds:

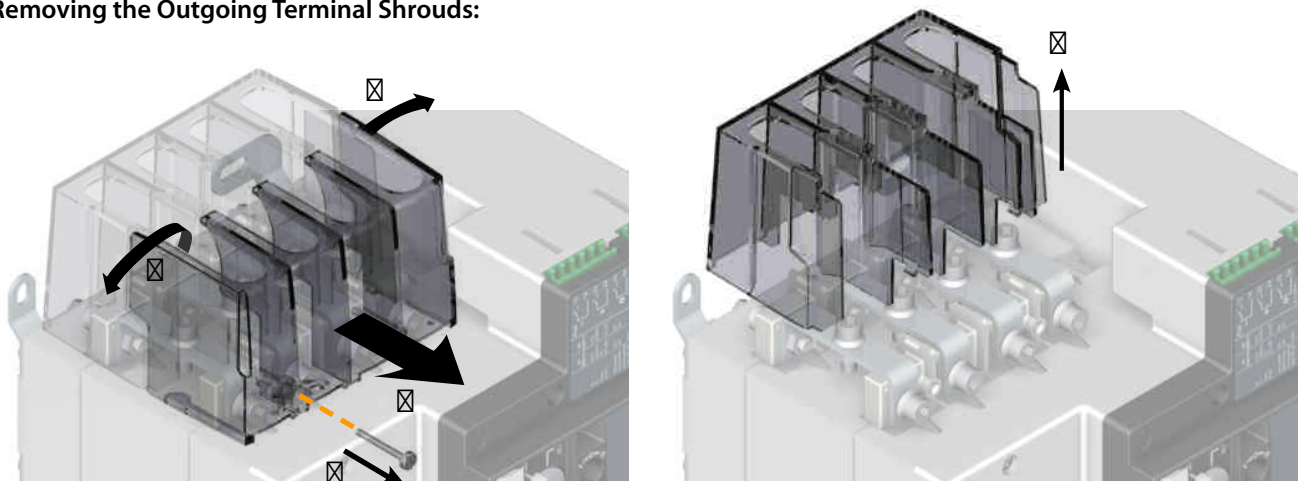

It is recommended to first install the bar closest to the motorization module followed by the adjacent bar until all 4 poles are installed. Pay attention to the tightening torque recommendations below.

Note:

Switch II screws and washers should be mounted from the rear towards the front using the nuts fixed to the bridging bars for retaining. These replace 4 retaining nuts initially delivered loose with the switch therefore those 4 off extra nuts should be discarded. Switch I screws and washers should be mounted from the front towards the rear using the loose nuts provided fit into the back of the switch terminals.

Bridging bars may be fit as Top or Bottom in the same manner as described above.

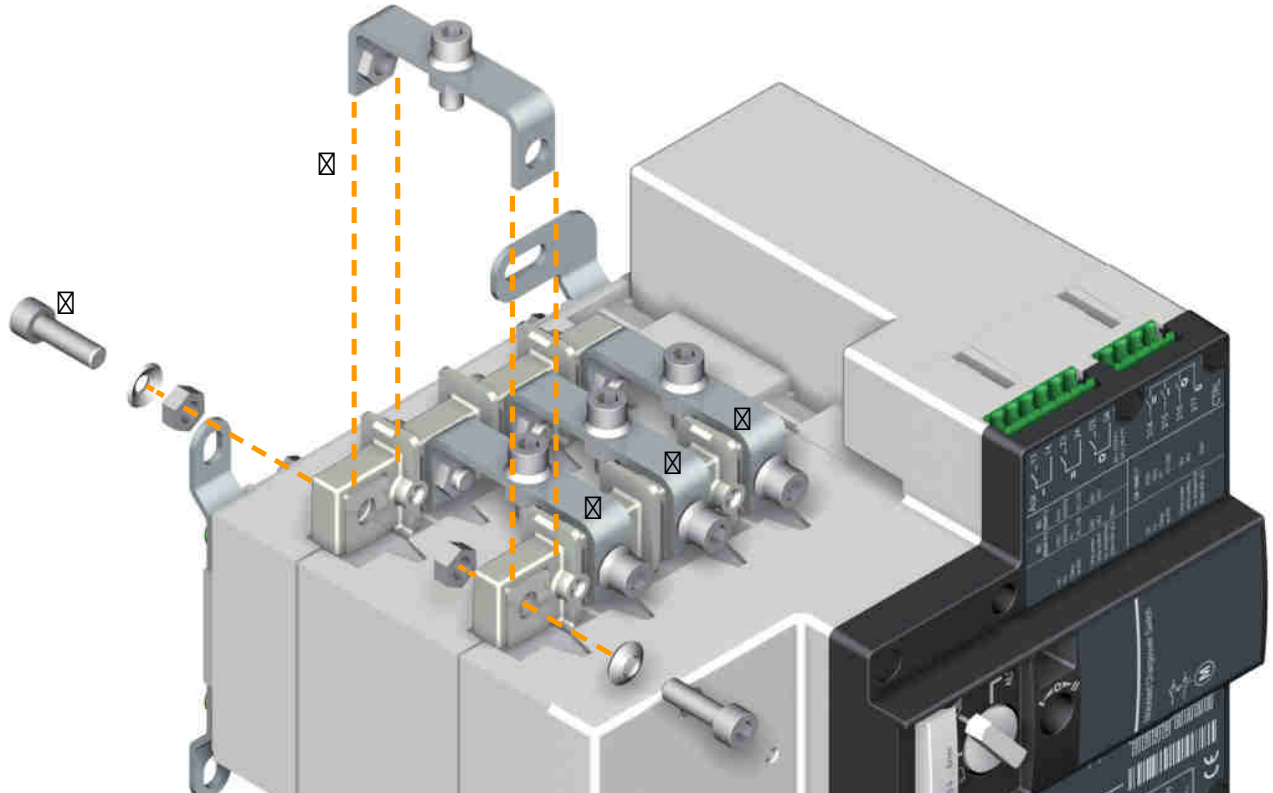

	40A to 125A
Recommended tightening torque (N.m)	4.5
Maximum tightening torque (N.m.)	5.4
Type of screw	M6

All values are indicative

6.3.2. Terminal Shrouds

Top and Bottom Terminal Shrouds are available for 40A to 125A products having the power connections wired with suitable cable lugs of up to 50 mm². The terminal shrouds have a design that includes a facility for sealing without the need of any specific accessory other than the seal itself.

6.3.2.1. Outgoing Terminal Shrouds (When using bridging bars)

The Outgoing terminal shrouds are designed specifically to accept the 4P bridging bar assembly and enclose all around the terminals and outgoing live parts. One kit includes 2 parts each being specific for switch 1 and switch 2. For ease of use please take note of the fitting instructions below.

Installing the Outgoing Terminal Shrouds:

6.3.2.2. Incoming Terminal Shrouds

The Incoming terminal shrouds may be fit to any side of the product (Incoming or Outgoing terminals) that are not fit with bridging bars.

One kit ordered includes 2 identical parts, front mounted, one for each switch.

Included with a terminal shroud kit are sealing screws to limit the access to terminals.

The shrouds fit to front switch are designed in a way to allow for thermographic measurements without the need to remove the shroud.

Installing the Incoming Terminal Shrouds

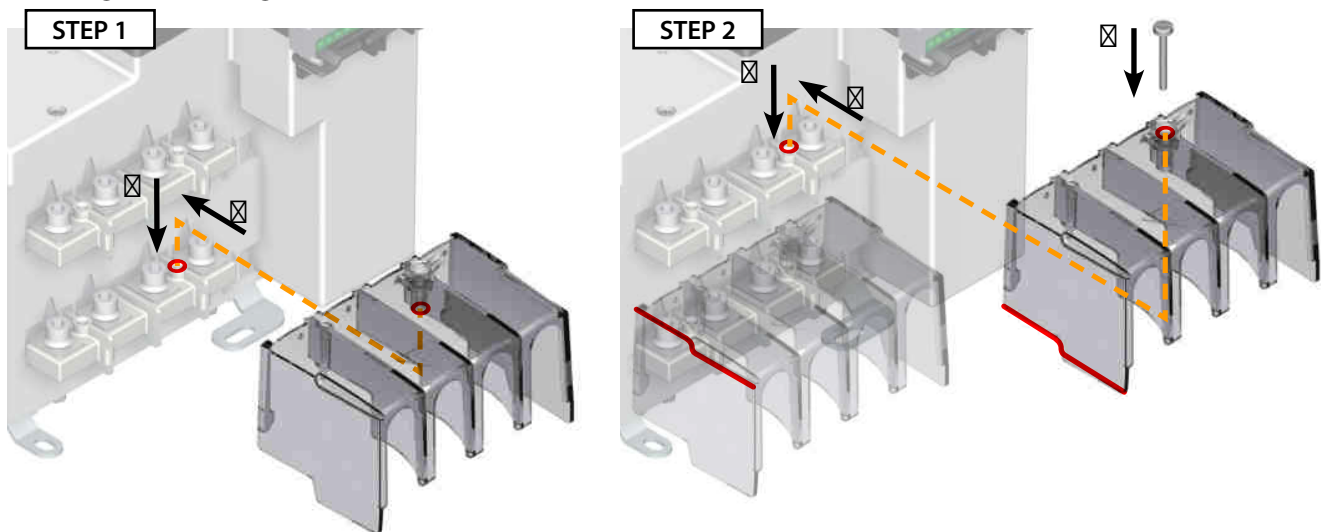

Removing the Incoming Terminal Shrouds

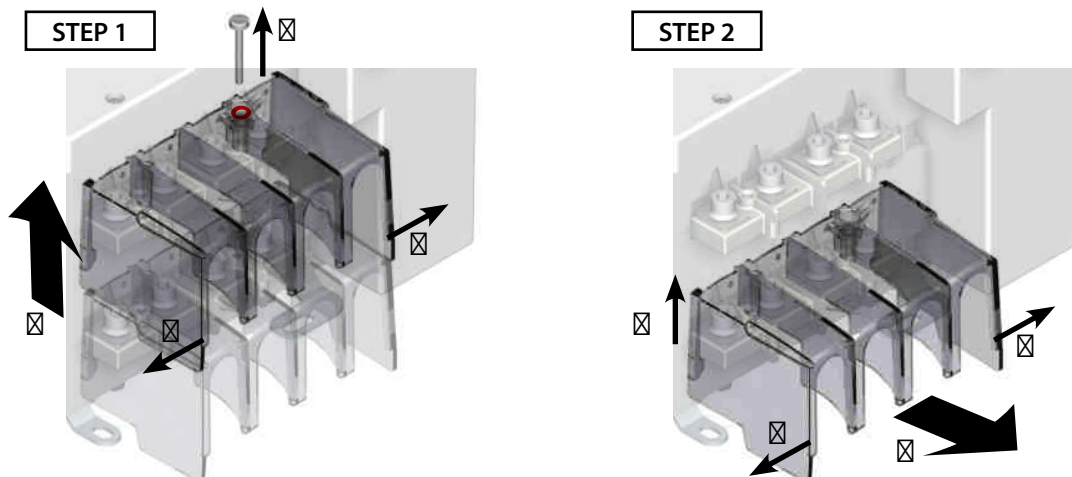

6.3.2.3. Sealing Facility for added security

The terminal shrouds include a sealing facility fully integrated in the design.

For ease of entry pay attention to the arrow that indicates the direction.

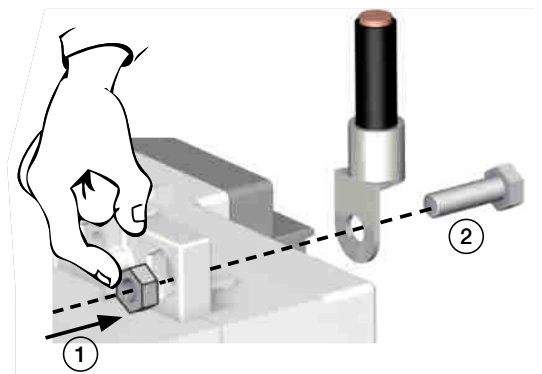
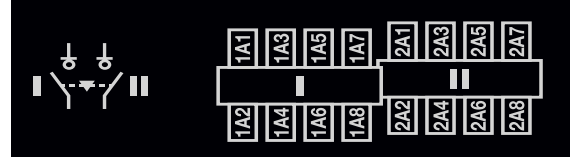
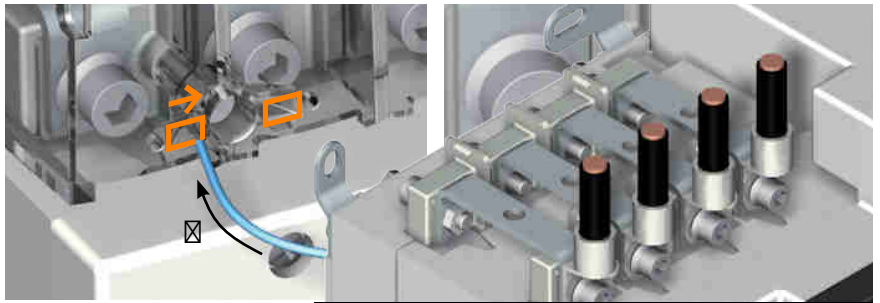
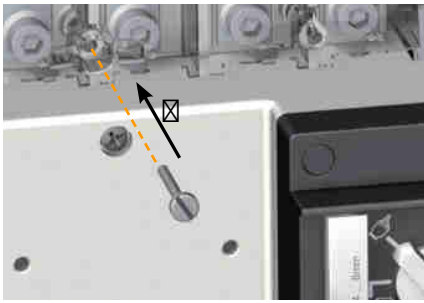

6.3.3. Direct handle and storage clip

The MLBS include a handle and storage clip for emergency manual operation. The handle comes with a standard 8mm hexagon extension shaft that fits into the front of the MLBS for safe and easy manual operation. Despite that the shaft includes a keyway the MLBS will also accept a standard 8mm allen key.

For added safety, the handle may only be inserted into the shaft location in the front of the MLBS when the mode selector switch is in manual mode position.

In the unlikely event of a motorization module failure the module may be removed as described below (4 screws). Emergency manual operation remains fully operational with the motorization module removed. To do this the hexagon shaft must be removed from the handle by removing the central retaining screw on the handle. This will convert the male hexagon shaft into a 10mm female direct handle compatible with the bare switch mechanism.

The emergency direct handle storage clip has been designed to fit virtually anywhere:

- Din rail mounting

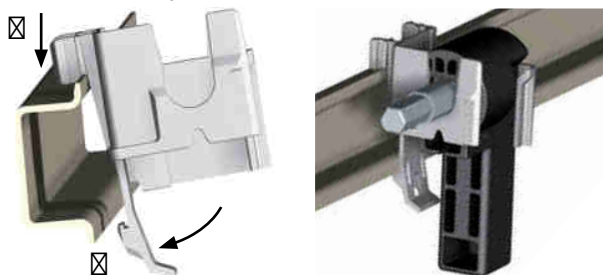

- Clipped directly into the side of the MLBS

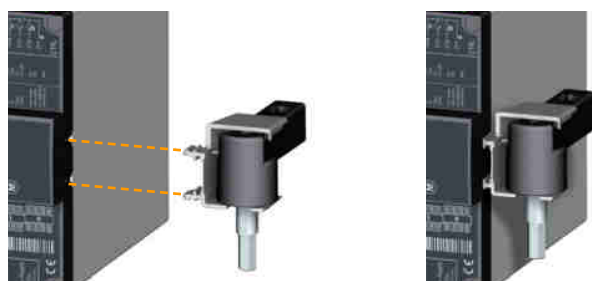

- Clipped into the top or bottom secure connector bracket accessory.

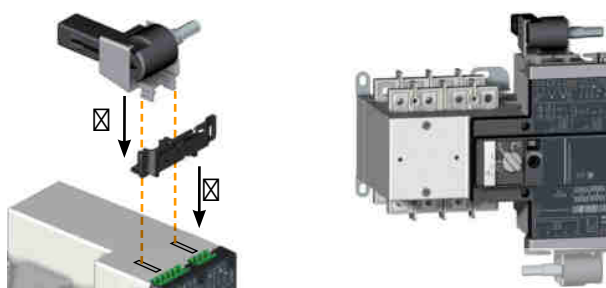

The same emergency handle may be used with and without the motorization in place.

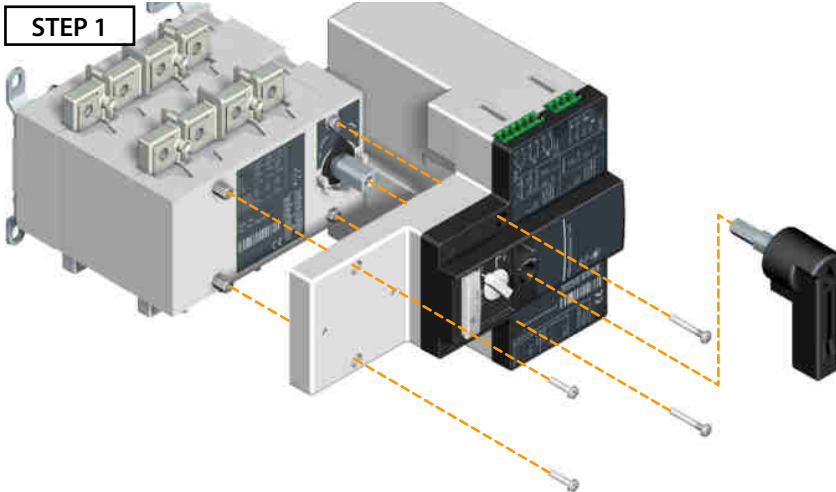

STEP 2

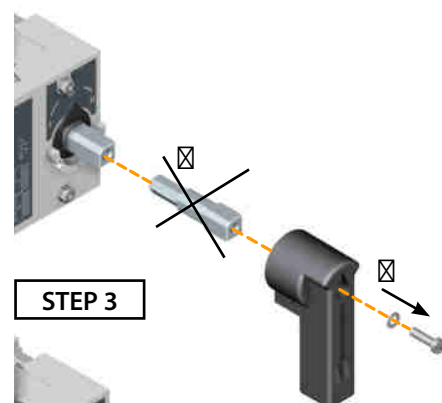

STEP 3

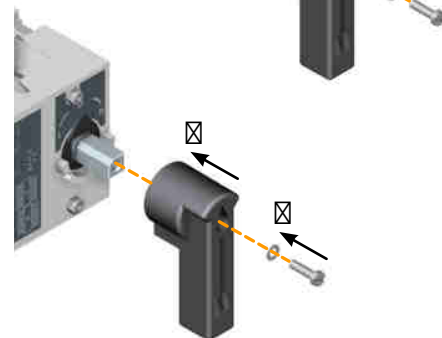

7. CONNECTIONS

7.1. Power Circuits

7.1.1. Cable Connections

	40A to 125A
Recommended tightening torque (N.m)	4.5
Maximum tightening torque (N.m.)	5.4
Type of screw	M6

All values are indicative

7.1.2. Power Connection Terminals

40A to 125A



Alternative connection facility for ease of outgoing cable.

The incoming; outgoing & bridging connections may be used as top or bottom depending on customer requirements.

7.1.3. Power Connection Sectional Area

	40A	63A	80A	100A	125A
Minimum cable section Cu (mm ²) at lth	10	16	25	35	50
Maximum cable section Cu (mm ²) at lth	70	70	70	70	70

All values are indicative

Note for all rating data:

Take into account the connection cable lengths when defining the cable section.

The voltage tapping kit and terminal shrouds are designed to be used with lugs for cables of up to 50 mm² and 70 mm specific lugs.

7.2. Control Circuits

7.2.1. Typical MLBS wiring diagrams

	<p>Verify that the Auxiliary power supply feeding terminals the Auxiliary supply voltage are within the limits. Refer to derating in the operating conditions section for specific ambient temperatures.</p> <p>The maximum control cable length for terminals 314 – 317 is to be limited up to 100m/800Ω. In case of longer distances or a higher resistance include control relays.</p>
--	---

	<p>Do not handle any control or power cables connected to the MLBS when voltage may be, or may become present.</p>
--	--

7.2.1.1. MLBS : 230Vac

Example: Control wiring for a 415Vac application using an MLBS having a 3 phase and neutral power source and a 230Vac control power supply;

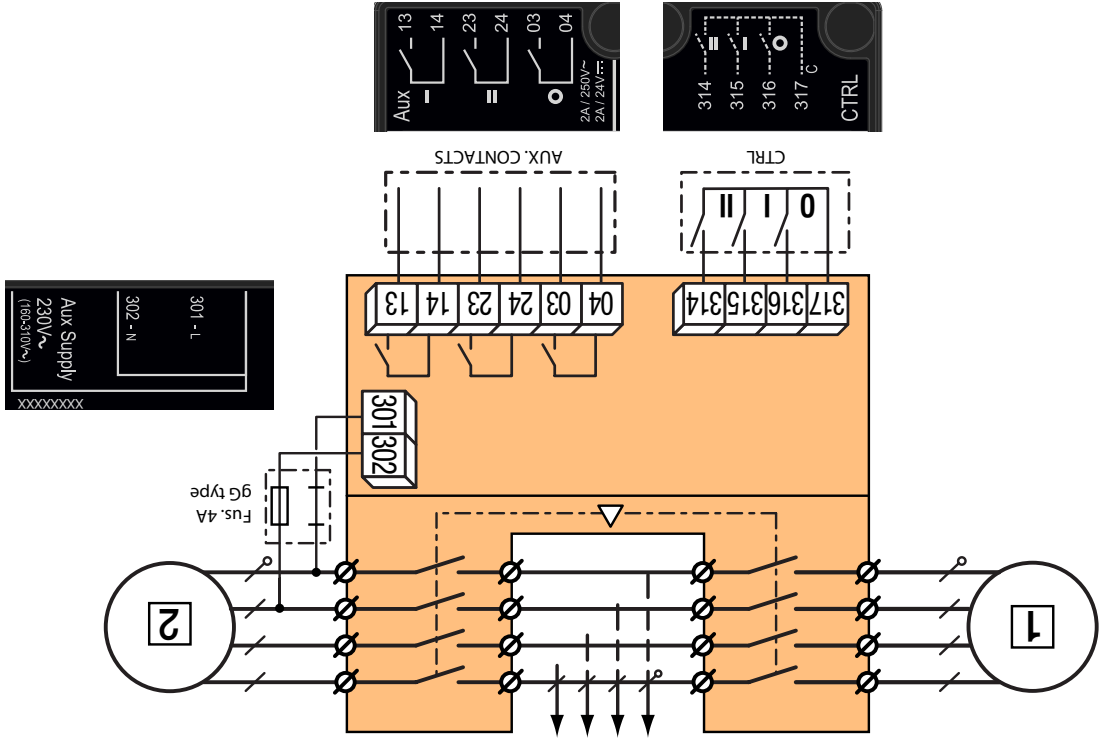

7.2.1.2. MLBS : 12Vdc

Example: Control wiring for a 415Vac application using an MLBS having a 3 phase and neutral power source and a 12Vdc control power supply.

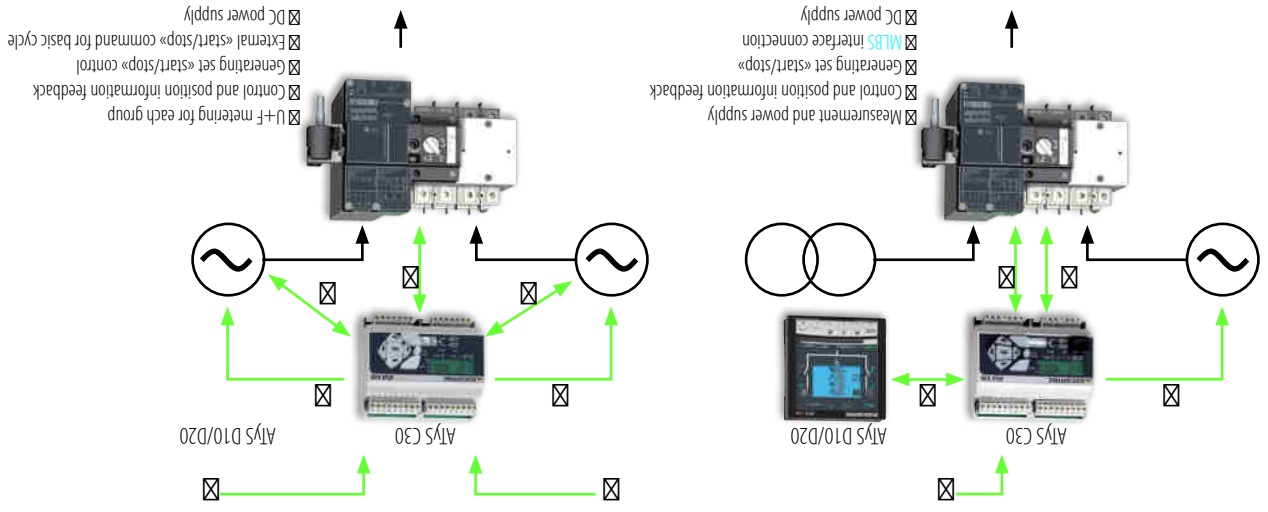

Refer to the relevant ATYS controller instruction manual for ATYS C30 and ATYS C40 details

7.2.2. MLBS RTSE + ATS Controllers type ATYS C30 and ATYS C40

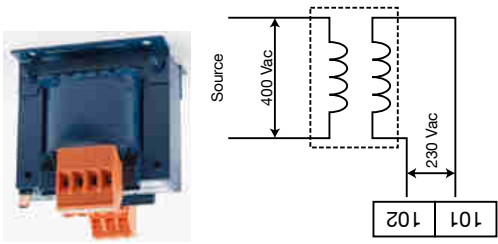

Power Transformer intended for 400 Vac, Phase to Phase voltage applications that do not provide the availability of a neutral conductor. Transformer data: 400Vac – 230Vac; 50VA. (Drawing for MLBS 230Vac)

7.2.1.3. External Power Supply (400Vac)

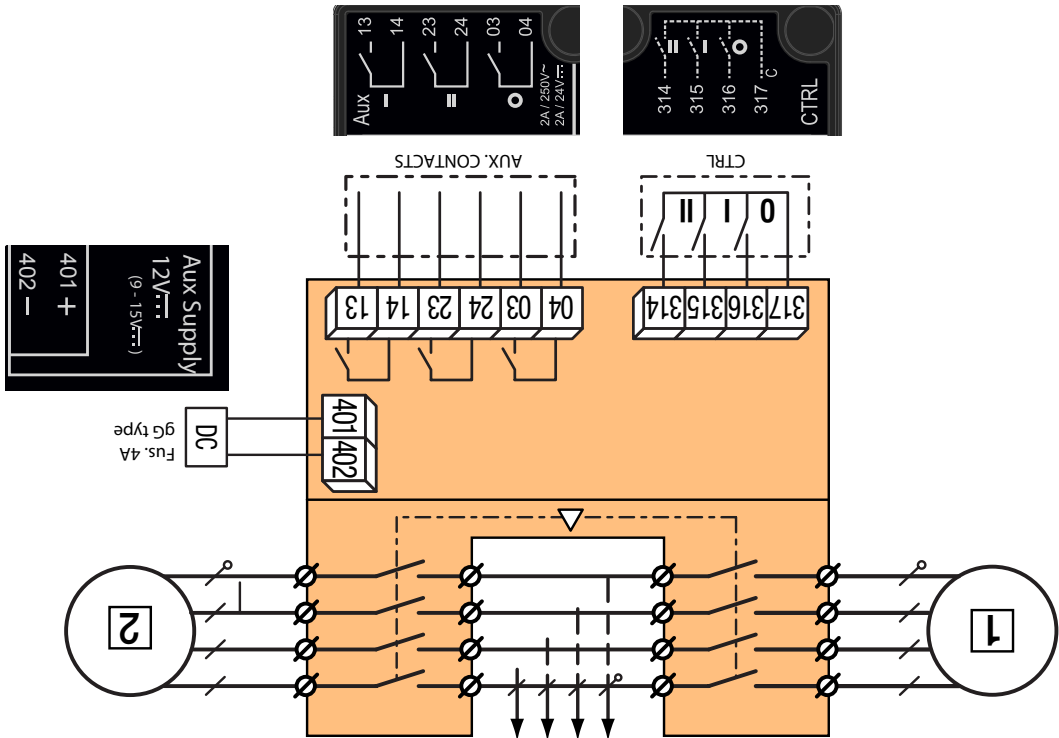

7.2.3. MLBS Input and Output Contacts

Independant Aux Contacts

- **Pos I:** Aux Contact 13/14
- **Pos II:** Aux Contact 23/24
- **Pos O:** Aux Contact 03/04

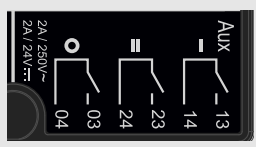

Position Commands (non standard)

- **Sw to Pos II I/P:** 314
- **Sw to Pos I I/P:** 315
- **Sw to Pos O I/P:** 316
- **Common:** 317



Power Connections S1, S2, Load

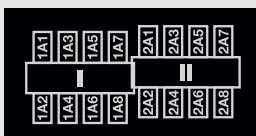
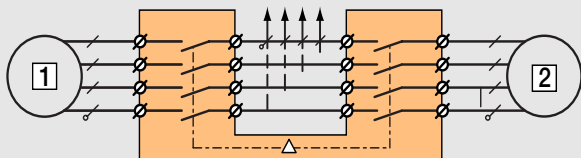



Power Supply Options

MLBS AC Supply



MLBS DC Supply



ENGLISH



7.2.4. Terminal denomination, description and characteristics.

Denomination	Terminal	Description	Characteristics	Recommended Cable Section	
Power Supply Input	101	Power Supply : L (ATyS Sd : 230V)	230Vac +/- 30% (160-310Vac) 50/60Hz	1,5 mm ²	
	102	Power Supply : N (ATyS Sd : 230V)			
	201	Power Supply : L (ATyS Sd : 230V)			
	202	Power Supply : N (ATyS Sd : 230V)			
	301	Power Supply : L (MLBS : 230V)			
	302	Power Supply : N (MLBS : 230V)			
	401	Power Supply : Positive + (MLBS : 12/24/48Vdc) *12Vdc -25%/+30%, Others +/- 30%			*12Vdc (9-15Vdc) 24/48Vdc (17-62Vdc)
	402	Power Supply : Negative - (MLBS : 12/24/48Vdc)			
Control Inputs	314	Position II order if closed with 317	ATTN: Do not connect to any Power Supply Non isolated	1,5 mm ²	
	315	Position I order if closed with 317			
	316	Position O order if closed with 317			
	317	Common control terminal for 314 - 316 (Specific Voltage Supply)			
Signalisation Outputs	03	Dry Contact : Aux Contact Position O Normally Open Contact	Dry Contacts 2A AC1 / 250V 2A / 24Vdc	1,5 mm ²	
	04				
	23	Dry Contact : Aux Contact Position I Normally Open Contact			
	24				
	13	Dry Contact : Aux Contact Position II Normally Open Contact			
	14				

8. MLBS OPERATING MODES

The MLBS includes 3 safe and distinct operating modes through a selector switch located on the front of the product. The modes of operation are as follows :

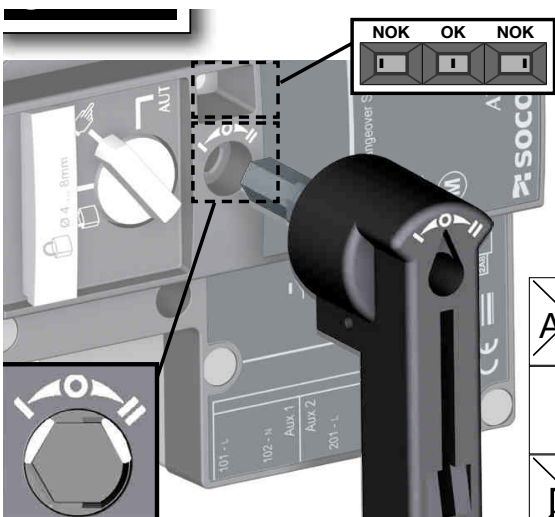
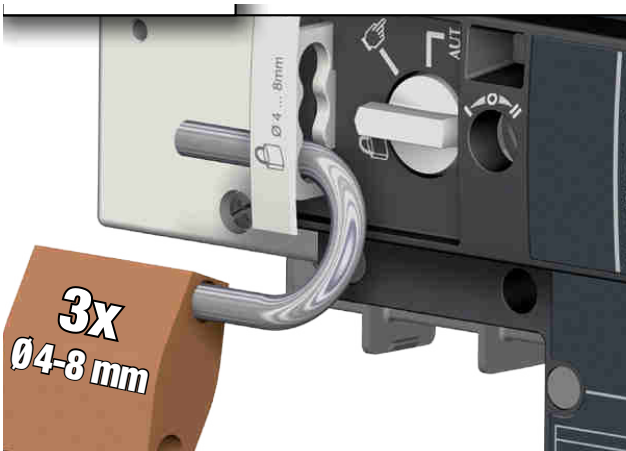
- **Auto Mode:** "Remotely operated transfer switching"
- **Manual Mode:** "Local emergency manual operation"
- **Locked Mode:** "Secure locked padlocking facility"

<p>AUT MODE</p>		<p>AUT</p>	<p>AUTO MODE:</p> <ul style="list-style-type: none"> • Activates control inputs. • Inhibits the padlocking facility • Inhibits the insertion of the manual operation handle when in AUT Mode <p>AUTO Mode position is inhibited when padlocked or when the handle for manual operation is inserted into the MLBS.</p>
<p>MODE</p>		<p>AUT</p>	<p>MANUAL MODE:</p> <ul style="list-style-type: none"> • Inhibits the control inputs. • Allows to insert the handle for emergency manual operation. <p>Note: Pay attention to the keyway when inserting the emergency handle into the product.</p> <p>Attention: When operating manually ensure that the position indicator is centred in the window when in the desired position.</p>
<p>MODE</p>		<p>AUT</p>	<p>LOCKED MODE: (Padlocked)</p> <ul style="list-style-type: none"> • Inhibits the control inputs. • Inhibits insertion of the emergency handle. • Accepts up to 3 padlocks with a dia. of 4-8mm. • Allows padlocking when the MLBS is in 0 Position. <p> </p>

8.1. Auto Mode : Electrical Operation

8.1.1. Power Supply

The **MLBS** 230Vac version is to be powered between terminals 301 and 302 with a supply within the limits of:

- 230Vac +/- 30% (160 – 310Vac)
- 50/60Hz +/- 10%



The **MLBS** 12Vdc version is to be powered between terminals 401 and 402 with a supply within the limits of:

- 12Vdc – 25% / + 30% (9 – 15Vdc)

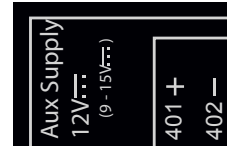

Current Input: AC control versions

- <20mA (Standby mode)
- 0.2A – 0.4A (Switching mode)
- 0.7A – 1.25A for 100ms (Inrush)

Current Input: 24/48 Vdc control versions

- <20mA (Standby mode)
- 1.5A (Switching mode)
- 7 – 9A for 100ms (Inrush)

Current Input: 12 Vdc control versions

- <20mA (Standby mode)
- 1.3A – 1.8A (Switching mode)
- 5 – 6.5A for 100ms (Inrush)

Terminal connector: (Control wiring)

- Minimum 1.5mm²
- Maximum 2.5mm²

8.1.2. Command Inputs - Description

The **MLBS** includes for 3 off command inputs through a 4 pin connector. No additional power supply should be used on these contacts as the inputs **MUST** be used with the common supply off terminal 317. These contacts are non isolated.

The **MLBS** power supply must be available to activate inputs 314 to 317. Pulse duration for activation : ≤ 60ms.



- Pin 314:- Position II order if closed with 317.
This contact is active with the **MLBS** in AUT mode.
Impulse duration to activate and switch to position II is a minimum of 30 to 60ms.
- Pin 315:- Position I order if closed with 317.
This contact is active with the **MLBS** in AUT mode.
Impulse duration to activate and switch to position I is a minimum of 30 to 60ms.
- Pin 316:- Position 0 order if closed with 317.
This contact is active with the **MLBS** in AUT mode.
Impulse duration to activate and switch to position 0 is a minimum of 30 to 60ms.
For contactor logic maintain contacts on between terminal 316 and 317.
- Pin 317:- Common for inputs 314 to 316.

8.1.3. Command Inputs - Technical Data

- Command Input Qty: 3 x non isolated command inputs
- Direct Voltage : <5Vdc (On any input with respect to ground)
- Direct Current lin : 0.35 to 0.5mA
- Line resistance : 800Ω
- Line length : 100m (Minimum wire 1.5mm² (#16AWG))
- Pulse duration : 30 - 60ms
- Terminal connector: 1.5mm² minimum / 2.5mm² maximum

8.1.4. Command Inputs - Control Logic

Switching operation can be driven in AUT mode by external volt free contacts as described above.

Depending on the wiring configuration there are two types of logic that may be applied to the MLBS.

- Impulse or
- Contactor logic.

The MLBS input logic gives priority to orders I and II over 0 therefore contactor logic can be implemented by bridging terminals 316 and 317.

<p>Impulse logic:</p> <p>The MLBS is driven to stable positions (I – 0 – II) after receiving an impulse order.</p> <ul style="list-style-type: none"> • A switching command of at least 60 ms is necessary to initiate the switching operation. • Orders I and II have priority over order 0. 	
<p>Contactor Logic:</p> <p>The MLBS is driven to a specific position (I or II) for as long as the order is maintained.</p> <ul style="list-style-type: none"> • Order 0 is maintained. (Bridge 316 – 317) • Orders I and II have priority over order 0. • Orders I and II have equal priority. (1st order received is held until no longer maintained). • If order I or II disappears, the device returns to zero position. (With the power supply available). 	

8.1.5. Dry Contact Outputs – Auxiliary

The MLBS is equipped with integrated independent position (I – 0 – II) auxiliary contact outputs through 3 off micro switches.

Dry contacts to be powered by the user.

- Pins 13 – 14, 23 – 24, 03 – 04
(Normally Open and independent contacts)

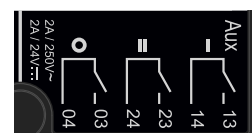

• Auxiliary Contact Quantity	3
• Configuration	NO
• Mechanical Endurance	100k cycles
• Rated Voltage / Switching Voltage	250Vac / 24Vdc / 48Vdc
• Rated Current	2A
• Output Terminals	1.5mm ² minimum / 2.5mm ² maximum

8.2. Emergency Manual Operation

The MLBS can be manually operated as a “Manual Transfer Switch Equipment – MTSE” whilst retaining the electrical characteristics and performance of the power switching function. This function is usually used in case of emergencies or during maintenance.

To operate the MLBS manually ensure that no live parts are accessible, turn the front selector switch into the manual position (figure 4.1 item 11) and insert the handle (figure 4.1 item 7) into the emergency handle shaft location hole provided (figure 4.1 item 10). The shaft location includes a keyway to guide the handle into the right position.

Turn the handle 60° clockwise or anti-clockwise (depending on the position to be reached) for each consecutive change in position.

I à 0	60° Clockwise
I à 0 à II	60° + 60° Clockwise
II à 0	60° Anti Clockwise
II à 0 à I	60° + 60° Anti Clockwise

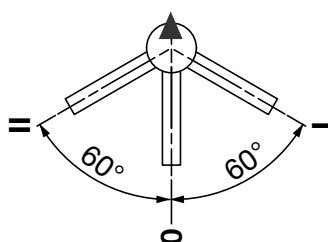

Attention: When operating manually ensure that the position indicator is centred in the window when in the desired position.

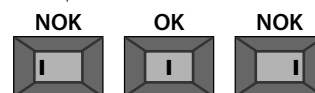

CAUTION

Ensure to verify the product position and direction of rotation before effecting manual operation.

Ensure to remove the handle from the product before changing the selector switch to AUT or padlocking position.

8.3. Padlocking

The MLBS can be padlocked in the 0 position using up to 3 padlocks.

To padlock the MLBS first ensure that the manual operation handle is not inserted into the location hole, then turn the front selector switch onto the padlock position.

Pull the padlocking mechanism outwards to reveal the slot for inserting the padlocks.

Padlock the device with approved quality padlocks of minimum diameter 4mm and maximum diameter of 8mm. A maximum of 3x 8mm padlocks may be padlocked onto the MLBS padlocking mechanism.

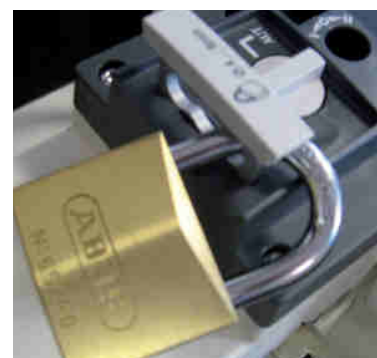
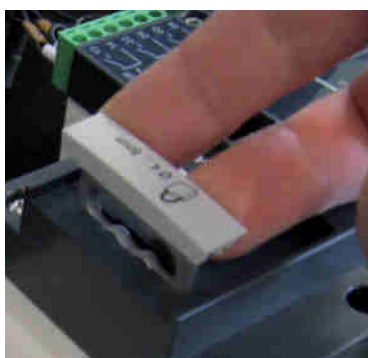

CAUTION

Padlocking is allowed in the “0 position”, when in padlock mode and with the emergency handle not inserted into the shaft location.

9. MLBS CHARACTERISTICS

Characteristics according to IEC 60947-3 and IEC 60947-6-1

40 to 125 A

Thermal current I_{th} at 40°C		40 A	63 A	80 A	100 A	125 A
Rated insulation voltage U_i (V) (power circuit)		800	800	800	800	800
Rated impulse withstand voltage U_{imp} (kV) (power circuit)		6	6	6	6	6
Rated insulation voltage U_i (V) (operation circuit)		300	300	300	300	300
Rated impulse withstand voltage U_{imp} (kV) (operation circuit)		4	4	4	4	4
Rated operational currents I_e (A) according to IEC 60947-3						
Rated voltage	Utilisation category	A/B	A/B	A/B	A/B	A/B
415 VAC	AC-20 A / AC-20 B	40/40	63/63	80/80	100/100	125/125
415 VAC	AC-21 A / AC-21 B	40/40	63/63	80/80	100/100	100/125
415 VAC	AC-22 A / AC-22 B	40/40	63/63	80/80	100/100	100/100
415 VAC	AC-23 A / AC-23 B	-/40	-/63	-/63	-/63	-/63
Rated operational currents I_e (A) according to IEC 60947-6-1						
Rated voltage	Utilisation category	A/B	A/B	A/B	A/B	A/B
415 VAC	AC-31 B	40	63	80	100	125
415 VAC	AC-32 B	40	63	80	80	80
Fuse protected short-circuit withstand (kA rms prospective)						
Prospective short-circuit current (kA rms)		50	50	50	25	15
Associated fuse rating (A)		40	63	80	100	125
Circuit breaker protected short-circuit withstand with any circuit breaker that ensures tripping in less than 0.3s ⁽¹⁾						
Rated short-time withstand current 0.3s, I_{cw} (kA rms)		3.5	3.5	3.5	3.5	3.5
Short-circuit capacity (without protection)						
Rated short-time withstand current 1 s, I_{sw} (kA rms)		2.5	2.5	2.5	2.5	2.5
Rated short-circuit making capacity		4.5	4.5	4.5	4.5	4.5
Connection						
Maximum Cu cable cross-section (mm ²)		50	50	50	50	50
Tightening torque mini / maxi (Nm)		1.2/3	1.2/3	1.2/3	1.2/3	1.2/3
Switching time (Standard setting)						
I - 0 or II - 0 (ms)		500	500	500	500	500
I - II or II - I (ms)		1000	1000	1000	1000	1000
Duration of "electrical blackout" I - II (ms) minimum		500	500	500	500	500
Power supply						
Power supply 12 VDC min / max (VDC)		9/15	9/15	9/15	9/15	9/15
Power supply 24/48 VDC min / max (VDC)		17/62	17/62	17/62	17/62	17/62
Power supply 230 VAC min / max (VAC)		160/310	160/310	160/310	160/310	160/310
Control supply power demand						
Power supply 12 VDC inrush / nominal (VA)		200/40	200/40	200/40	200/40	200/40
Power supply 24/48 VDC inrush / nominal (VA)		200/40	200/40	200/40	200/40	200/40
Power supply 230 VAC inrush / nominal (VA)		200/40	200/40	200/40	200/40	200/40
Mechanical characteristics						
Durability (number of operating cycles)		10 000	10 000	10 000	10 000	10 000
Weight MLBS 4 P (kg)		3	3	3	3	3

(1) Value for coordination with any circuit breaker that ensures tripping in less than 0.3s. For coordination with specific circuit-breaker references, higher short-circuit current values are available. Please consult us.

10. TROUBLE SHOOTING GUIDE

The MLBS does not operate electrically	<ul style="list-style-type: none"> Verify the power supply on terminals 101 to 402 is within the acceptable voltage limits relative to the specific device and its intended nominal voltage. 12Vdc: 9 – 15Vdc 24/48Vdc: 17 – 62Vdc 230Vac: 160 – 310Vac Verify that the front selector switch is in position (AUT) Verify the contact terminal and contact signals between 314 and 317. Normally open contacts with priority to signals I & II.
It is not possible to manually operate the switch	<ul style="list-style-type: none"> Verify that the front selector switch position is on the Manual position. Make sure that the product is not padlocked. Verify the rotation direction of the handle. Apply a sufficient progressive action in the direction as indicated on the MLBS.
Electrical operation does not correspond to external order I, 0, II	<ul style="list-style-type: none"> Verify the selected control logic wiring (impulse or contactor) Impulse >60ms 314 – 317 : Switch to position II 315 – 317 : Switch to position I 316 – 317 : Switch to position 0 Maintained - Bridge between: 316 – 317 : Contactor Logic (Return to zero)
Impossible to padlock	<ul style="list-style-type: none"> Verify that the front selector switch is in padlocking position. Verify that the emergency handle for manual operation is not inserted into the MLBS manual slot. Verify that the MLBS is in 0 position. (Padlocking is only possible in 0 position with the emergency manual operation handle removed).
Product does not respond to remote orders	<ul style="list-style-type: none"> Put the product into manual mode and switch to the zero position using the emergency handle. Reset by switching from manual to auto in the zero position. Verify that AUX Supply voltage is within limits. Verify that the remote signals are being received.
Maintenance	<ul style="list-style-type: none"> It is recommended to operate the switch in auto or manual through a complete cycle at least once per year.

11. SPARES AND ACCESSORIES

11.1. Accessories

<p>Terminal Shrouds Source Side</p>  <p>Ref.: 004661701</p>	<p>Terminal Shrouds Load Side</p>  <p>Ref.: 004661702</p>
--	--

12. MLBS ORDERING INFORMATION

The following is an ordering guide for MLBS Motorised Changeover Switches delivered inclusive of the emergency handle and storage clip. This guide is intended so as to explain the logic behind ETI MLBS reference numbers.

When ordering please consult the latest ETI catalogue.

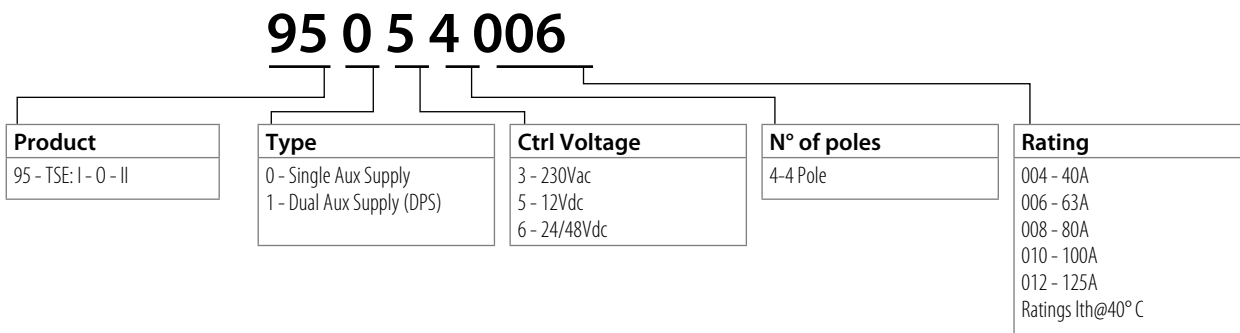

12.1. MLBS Catalogue Reference numbers

MLBS Rating	kVA at 415 Vac	N° of Poles	MLBS 12Vdc	MLBS 230Vac
63A	≤45 kVA	4	004661650	004661653
100A	≤70 kVA	4	004661651	004661654
125A	<90 kVA	4	004661652	004661655