

Technical data

Low breaking capacity moulded case circuit breakers EB2S

*F - fixed, A - adjustable

Product series	description	unit	condition	EB2S 160 F			EB2S 160 A			EB2S 250 F			EB2S 250 A			
Model-type				LF	SF	HF	LA	SA	HA	LF	SF	HF	LA	SA	HA	
Number of poles				3, 4												
Nominal current ratings																
	I_n	(A)	50°C	16, 20, 25, 32, 40, 50, 63, 80, 100, 125, 160			25, 40, 63, 80, 100, 125, 160			200, 250			200, 250			
Electrical characteristics																
Rated insulation voltage	U_i	(V)		690	690	690	690	690	690	690	690	690	690	690	690	
Rated impulse withstand voltage	U_{imp}	(kV)		8	8	8	8	8	8	8	8	8	8	8	8	
Ultimate breaking capacity (IEC, JIS, AS/NZS)																
	I_{cu}	(kA)	690V AC	-	-	6	-	-	6	-	-	4	-	-	4	
			525V AC	6	7,5	10	6	7,5	10	6	10	25	6	7,5	10	
			440V AC	10	15	25	10	15	25	10	15	30	10	15	30	
			380/400/415V AC	16	25	40	16	25	40	16	25	40	16	25	40	
			240V AC	25	35	50	25	35	50	25	35	85	25	35	85	
			250V DC	13	20	25	13	20	25	13	15	25	13	15	25	
			125V DC	20	30	40	20	30	40	20	25	40	20	25	40	
Service breaking capacity (IEC, JIS, AS/NZS)																
	I_{cs}	(kA)	690V AC	-	-	3	-	-	3	-	-	2	-	-	2	
			525V AC	3	4	7,5	3	4	7,5	3	7,5	13	3	6	7,5	
			440V AC	5	7,5	13	5	7,5	13	5	12	15	5	12	15	
			380/400/415V AC	8	13	20	8	13	20	8	19	20	8	19	20	
			240V AC	13	18	25	13	18	25	13	27	43	13	27	43	
			250V DC	7	10	13	7	10	13	7	12	13	7	12	13	
			125V DC	10	15	20	10	15	20	10	19	20	10	19	20	
Rated short-circuit making capacity	I_{cm}	(kA)	peak	33	33	33	33	33	33	33	33	33	33	33	33	
Rated short-circuit withstand current	I_{cw}	(kA)	rms	-	-	-	-	-	-	-	-	-	-	-	-	
Protection																
Fixed thermal, fixed magnetic						✓			-		✓				-	
Adjustable thermal, fixed magnetic						-			✓		-				-	
Adjustable thermal, adjustable magnetic						-			-		-				✓	
Utilization category						A			A		A				A	
Outline dimensions																
	height (b)	(mm)				130			130		165				165	
	width (a)	(mm)	3 pole			75			75		105				105	
	width (a)	(mm)	4 pole			100			100		140				140	
	depth (c)	(mm)				68			68		68				68	
	depth (d)	(mm)				93			93		95				95	
	toggle cutout (e)	(mm)				45			45		45				45	
Weight																
		(kg)	3 pole			0.8			0.8		1.5				1.5	
			4 pole			1.0			1.0		1.9				1.9	
Operation																
Direct Opening Action						✓			✓		✓				✓	
Trip button						✓			✓		✓				✓	
Suitable for isolation						✓			✓		✓				✓	
Standards																IEC 60947-2, EN 60947-2

I-t

EB2S 160 LF, EB2S 160 SF, EB2S 160 HF

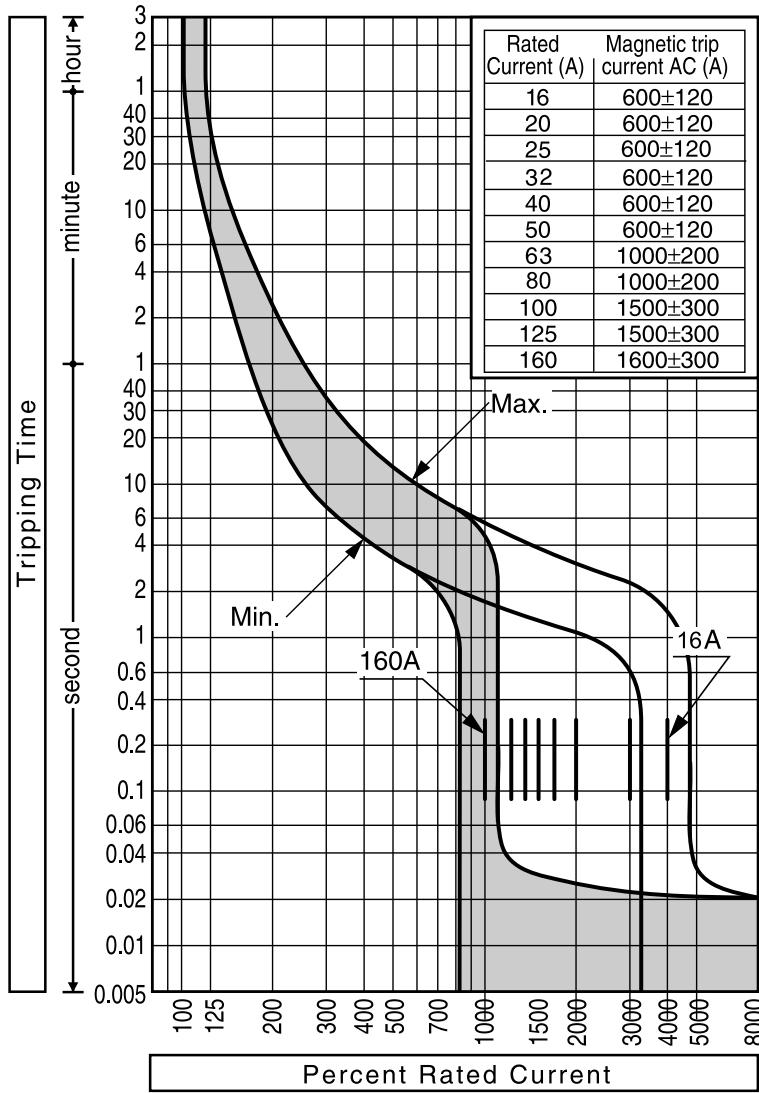

ETIBREAK

EB2S 160 LA, EB2S 160 SA, EB2S 160 HA

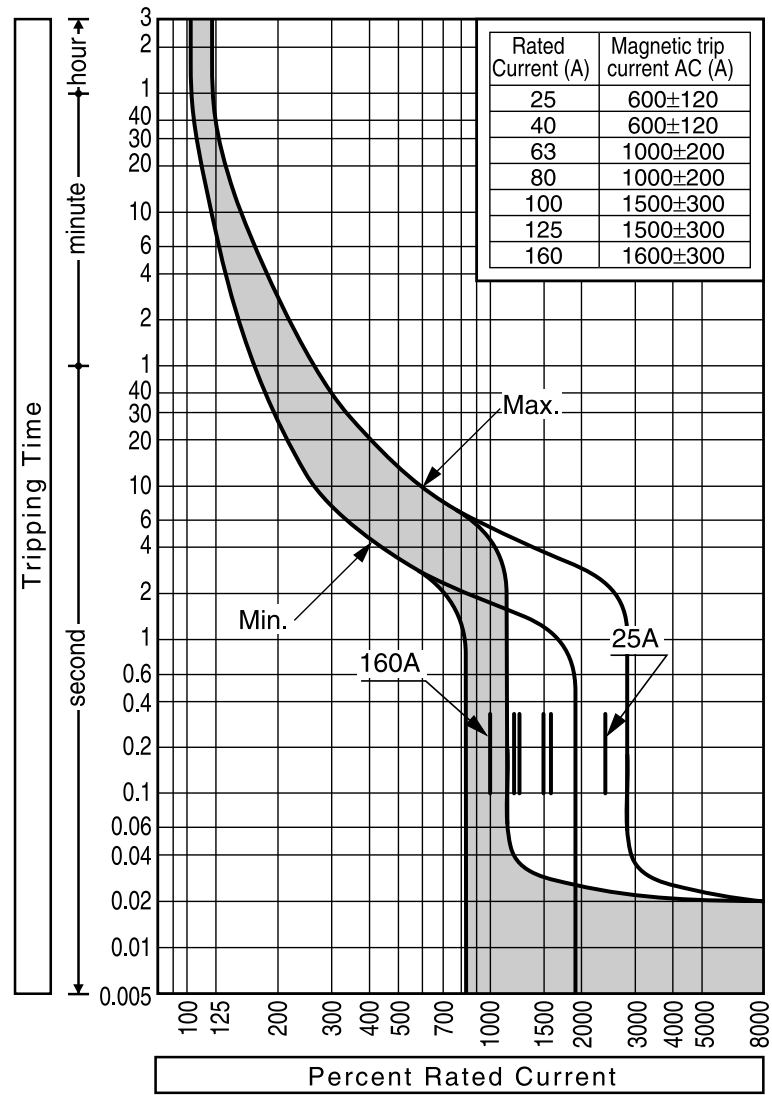

EB2S 250 LF, EB2S 250 SF, EB2S 250 HF

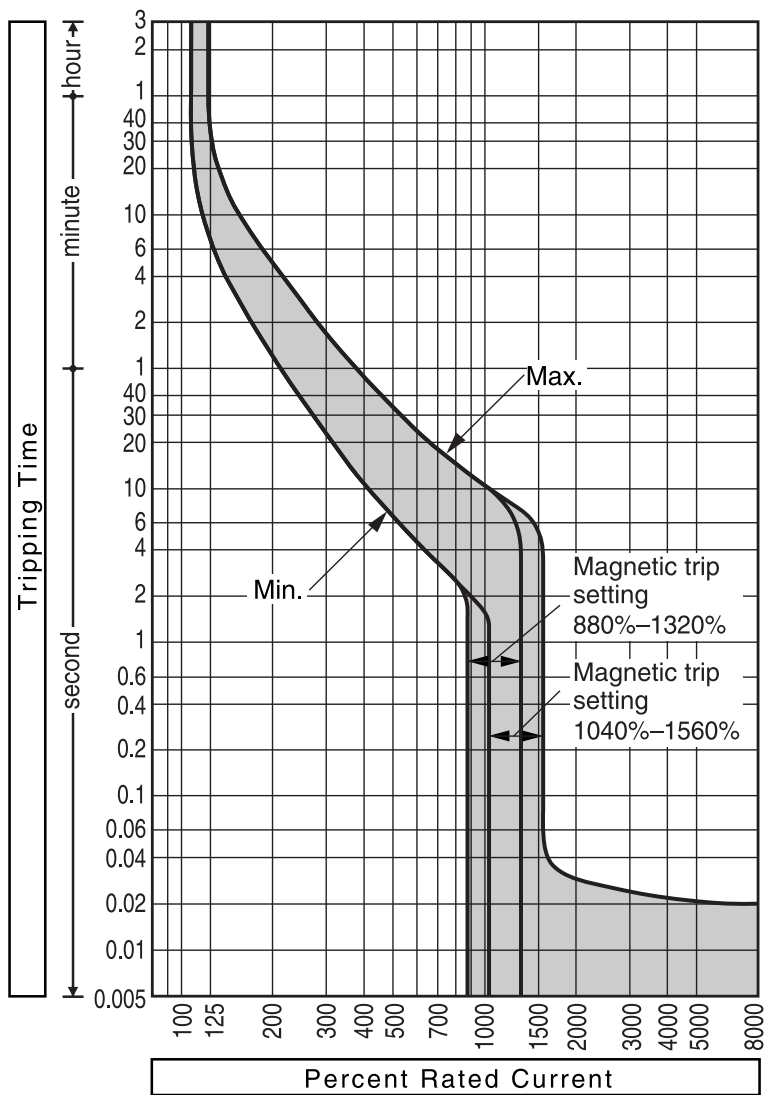

EB2S 250 LA, EB2S 250 SA, EB2S 250 HA

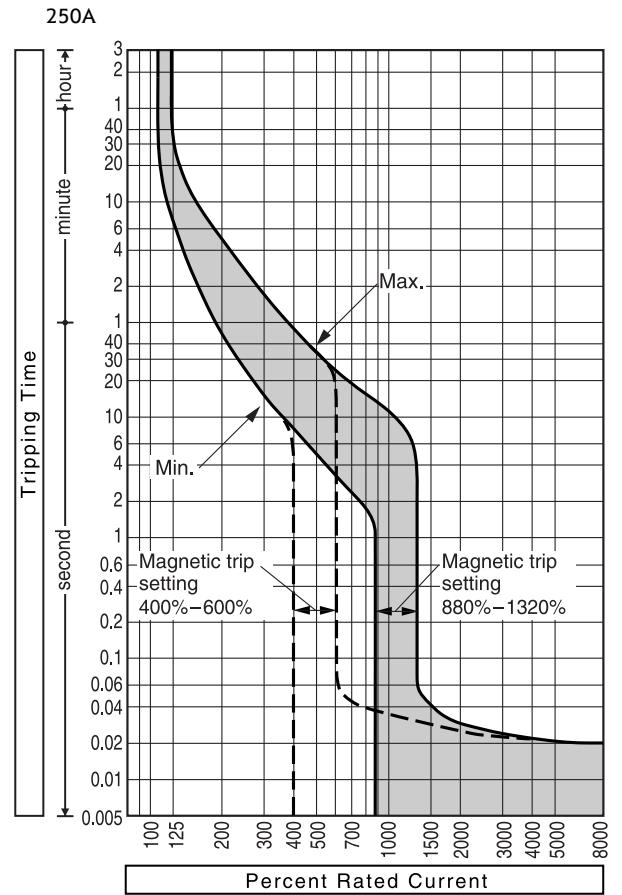
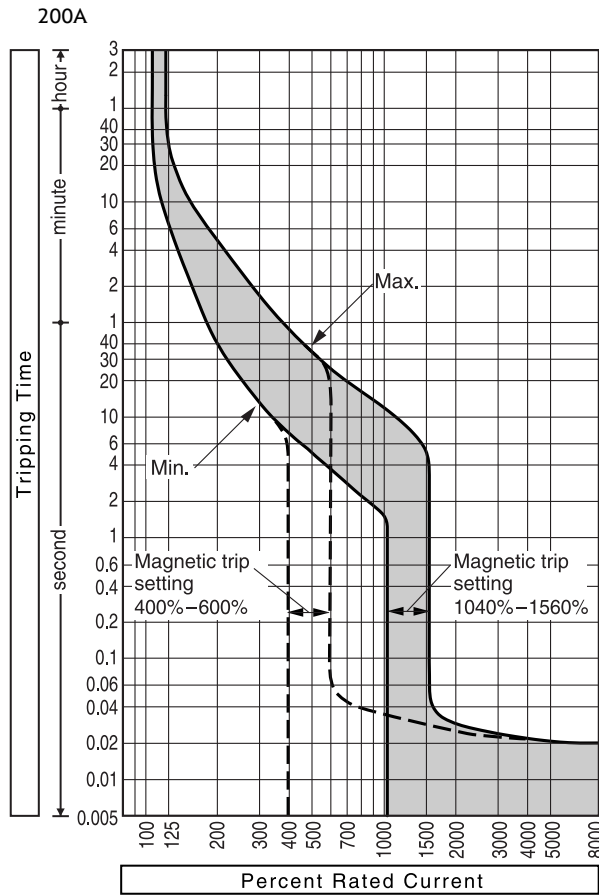

Internal accessories

EB2S 160 F&A

EB2S 250 F&A

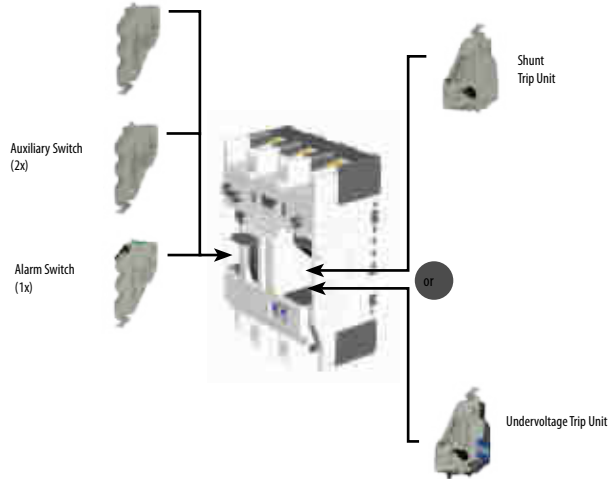
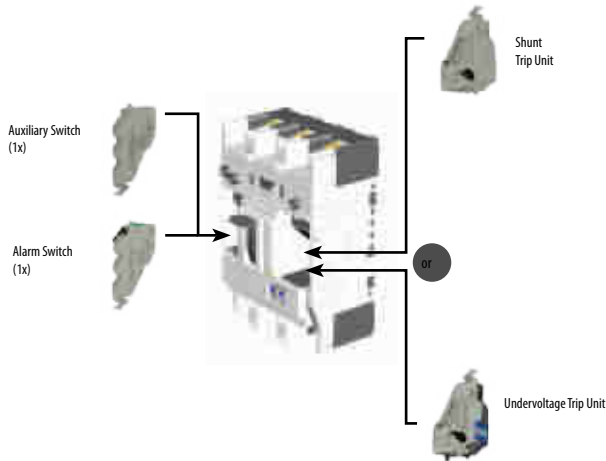

- Status indication switches mount in the left side of the MCCB.
- Only one alarm switch can be fitted to an MCCB.



Auxiliary Switch

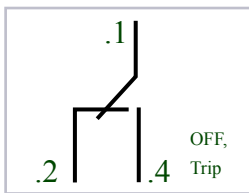

Terminal designations and function

Ratings of Auxiliary switch

Volts (V)	AC Amperes (A)		DC Amperes (A)	
	Resistive Load	Inductive Load	Resistive Load	Inductive Load
480	-	-	-	-
250	3	2	0.4	0.05
125	3	2	3	2

The inductive load means power factor of no smaller than 0.4 and time constant of no larger than 7 ms.



Alarm Switch

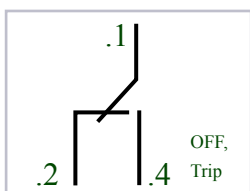

Terminal designations and function

Ratings of Alarm switch

Volts (V)	AC Amperes (A)		DC Amperes (A)	
	Resistive Load	Inductive Load	Resistive Load	Inductive Load
480	-	-	-	-
250	3	2	0.4	0.05
125	3	2	3	2

The inductive load means power factor of no smaller than 0.4 and time constant of no larger than 7 ms.

Technical data



Shunt Trip Unit

Ratings of Shunt Trip

Rated Voltage	Voltage AC		Voltage DC
	200-240	380-450	24
Excitation Current (A)	0.014	0.0065	0.03

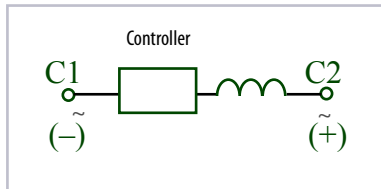

Terminal Designations of Shunt Trips

The permissible voltage is from 85% to 110% of the rated voltage for AC or 75% to 125% thereof for DC.

Ensure that the voltage does not drop exceeding the permissible voltage range when SHT is actuated.

Breaker contacts usually start opening within 30 ms after the rated voltage is applied to the breaker.



Undervoltage Trips

Ratings of Undervoltage Trips

Rated Voltage	Power supply capacity (VA)		Excitation current (mA)
	Voltage AC		Voltage DC
	200-240	380-450	24
Power Supply Capacity (A)	2.8	2.3	23

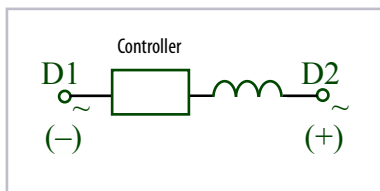

Terminal Designations of Undervoltage Trips

External accessories



Features

- Installation and removal ease: Simply rotate two knobs allows the motor operator to be installed on or removed from the breaker.
- High-speed, stable actuation: The operating time as short as up to 0.1 second makes it possible to use the motor operators for synchronized closing of breakers.
- Silent operation: MO2S use a direct drive system, providing operational silence.
- "Lock-in off" capability: This capability allows the breaker to be padlocked in the OFF state. Up to three padlocks with a 5 to 8 mm hasp diameter can be used. Padlocks are not supplied.

Ratings and specifications	
Rated operational voltage (1*)	230-240V AC
	24V DC
Peak steady-state/starting current, A (2*)	230-240V AC
	24V DC
Operation method	Motor driven (direct drive system)
Operating time, s at rated voltage	ON
	OFF/RESET
Operating switch ratings	100V 0.1A (open voltage/current: 44V/4 mA) (*5)
Power supply required	300VA or higher
Dielectric withstand voltage (for one minute)	1500V AC(1000V AC -> 24V DC)
Weight	1.4kg

1*: Permissible operating range is 85% to 110%.

2*: The currents shown are at the maximum rated operational voltage.

3*: The operating time is the value when the rated operational voltage is supplied. Allow the longer time for the motor operator to complete the operation.

4*: The motor operator is of a short time duty. Do not subject it to more than 10 continuous ON-OFF operations. If this occurs, allow the motor operator to cool for at least 15 minutes.

5*: When the rated operational voltage is DC24V the open voltage will be DC22V.

Motorized operation

The motor operator has an input-signal self-hold circuit; closing the ON or OFF switch (see circuit diagrams shown below) momentarily allows activating the motor operator. To reset the tripped breaker to the OFF position, close the OFF (RESET) switch. The voltage presence LED indication is on when the power is supplied to the motor operator.

■ Auto reset feature (optional)

The auto reset feature allows the breaker to be automatically reset approx. 1.5 seconds after the breaker trips open. This option contains auto-reset switches and does not require to use auxiliary or alarm switches installed in the breaker.

Note : that after the thermal OCR trips a thermal-magnetic breaker, the breaker cannot be immediately closed though it can be auto-reset. Wait for a few minutes after the tripping and provide a close signal to the breaker. This option resets the tripped breaker automatically, regardless of the cause of the tripping.

Manual operation

Pull the operating handle out. Rotating the handle counterclockwise turns ON the breaker and clockwise turns OFF or resets the breaker.

Operation precautions

1. Ensure that the actual operation voltage ranges from 85% to 110% of the rated one.
2. Use operation switches whose ratings and power capacity is as specified in the "Ratings and Specifications" table on the previous page.
3. Use noise filters if the control power supply of the motor operator is shared by peripheral devices. Otherwise, power supply noise may cause malfunction of the peripheral devices.
4. When the motors are used in conjunction with the mechanical interlock the electrical interlock should be provided between the motors in order to avoid the simultaneous closing. The followings are the available electrical interlock cables.

Technical data

Control circuit diagram of MO2S

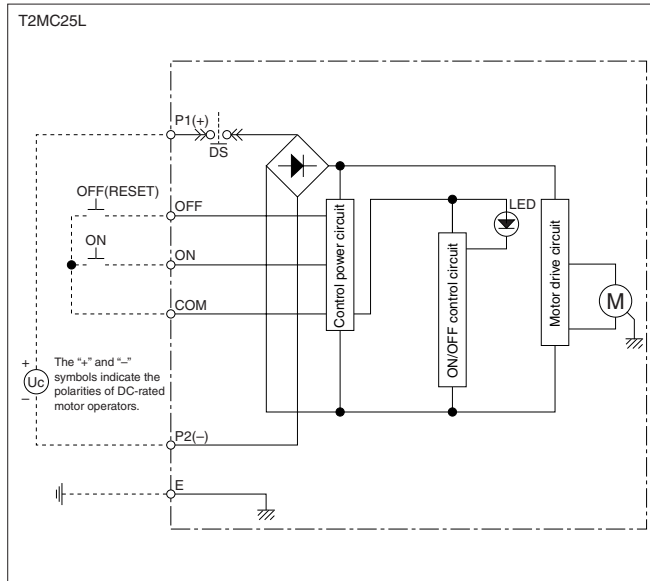

Dimensions

EB2S 160 F & A

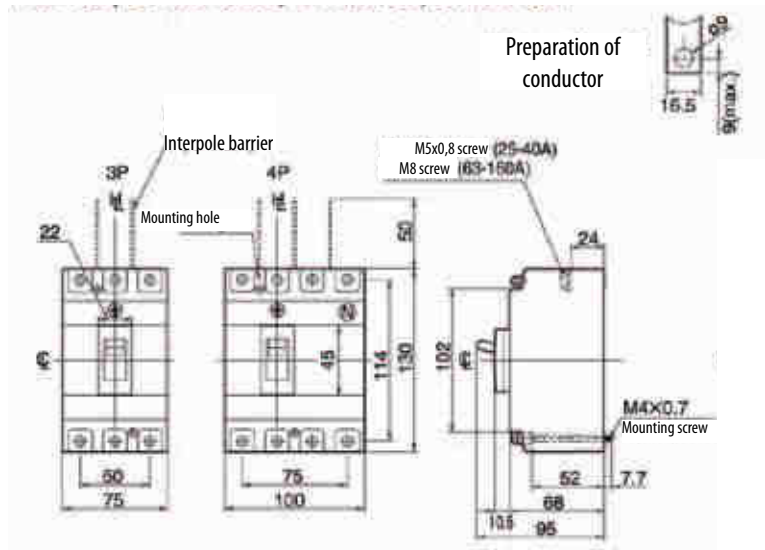

EB2S 250 F & A

