

Garancija:
Garancija za izdelek velja dve leti za okvare kot posledica napak v proizvodnji oz. vgrajenih materialov, v kolikor je izdelek uporabljen pod normalnimi pogoji in v skladu s predpisanimi nazivnimi vrednostmi izdelka.

Warranty:
ETI offers warranty of two years against defects in materials or manufacturing for standards products when they are applied under normal conditions and in accordance with the limit of their rated values.

Garancija:
Garancija za proizvod vrijedi dve godine za kvarove koji su posledica grešaka u proizvodnji ili ugrađenih materijala, ukoliko je proizvod korišten u normalnim uvjetima i u skladu sa propisanim nazivnim vrijednostima.

Gwarancja:
Firma ETI udziela gwarancji na okres 2 lat na bezawarynna pracy urzadzzenia podczas jego pracy w warunkach (parametrach) znamionowych

Zaruka:
ETI poskytuje zaruku dva roky na zavisly zpusobene vadou materialu nebo vyrobnymi postupy pred standardni vyroby, které jsou pouzity v die bežnych podminek a v souladu s limitem jejich stanovenych hodnot.

Zaruka:
ETI ponuka pre štandardne výrobky záruku dva roky na chyby na materiáli a výrobné chyby. Záruka platí pri bežných podmienkach a v súlade s najvyššími povolenými menovitými hodnotami.

Garancia:
A standard termék két év gyártási hibákból eredő karosszára két év garanciát vállalunk, amennyiben a meghibásodás normál üzemi körülmények mellett és a névleges értékeken belül működés során jelentkezik.

Garantija:
ETI duoda dveju metų garantiją standartiniams produktams, jeigu jie naudojami normaliomis darbo sąlygomis, atsižvelgiant į šiu produktų vardinjus parametrus.

Talokoma: Nagehoja produktams ar jų dalims kurios susidevi darbo metu

Гарантия:
Гарантия на устройство составляет 2 года для стандартных изделий при их эксплуатации в нормальных условиях а диапазоне номинальных характеристик.

Срок годности: Неограничен.

OPAZORILO

- Izključite napajanje pred začetkom del.
- Priključevanje in vzdrževanje naj izvaja samo usposobljeno osebe.

- Upoštevati je treba nacionalne, regionalne in lokalne standarde in navodila.

WARNING

- Disconnect power before proceeding with any work on this equipment.

- Installation and maintenance by technical personnel only.
- Attend the national, regional and local standards and follow the operating instructions.

OPPOZIORE

- Isključite napajanje prije početka radova.

- Priključivanje i održavanje smije izvoditi samo usposobljeno osobe.

- Poštovati treba nacionalne, regionalne i lokalne standarde i uputstva.

UWAGA

- Przed rozpoczęciem jakiegokolwiek pracy przy urządzeniu, należy wyłączyć zasilanie.

- Instalacja i konserwacja urządzenia powinna dokonać tylko wykwalifikowana osoba.

- Należy przestrzegać przepisów dotyczących ochrony przeciwporażeniowej oraz niniejszej instrukcji obsługi.

VAROVANI

- Pred začetkom jakikoli práce na tomto zariadení odpojte napájanie.

- Instaláciu a údržbu provádí pouze odborná osoba.

- Dbejte národných, regionálnych a miestnych noriem a dodržujte návod k použiti.

UPOZORNENIE

- Pred vykonávaním akýchkoľvek práce na tomto zariadení odpojte napájanie.

- Instaláciu a údržbu môžu vykonávať len technici pracovníci.

- Dodržiavajte platné normy a postupujte podľa návodu na používanie.

FÜGYELM

- Mielőtt bármilyen munkát végeznél ezen a berendezésen, kapcsolj ki a tápellátást.

- Az üzembeképezést és a karbantartást csak kiképzett műszak szakmésztel végezhet.

- Figyeld a figyelembe a nemzeti és helyi szabványok előírásait és kövessék a kezelési útmutató előírásait.

ISPEJIMAS

- Išjungti elektros energijos maitinimą, prieš pradėdami, bet kokį darbą su šiu įrengiu.

- Montavimo ir priežiūrą gali atlikti tik turintis atitinkamą kvalifikaciją personalas.

- Laikytis nacionalinių ir vietinių valdymo taisyklių ir standartų.

ВНИМАНИЕ
- Обратите внимание на национальные, региональные и местные стандарты и следуйте инструкции по эксплуатации.

- Установка и эксплуатация разрешается только подготовленному техническому персоналу.

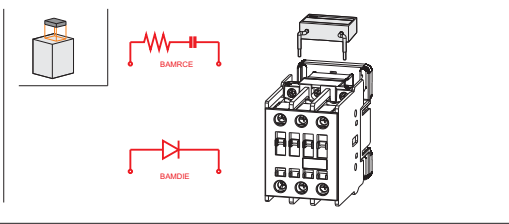
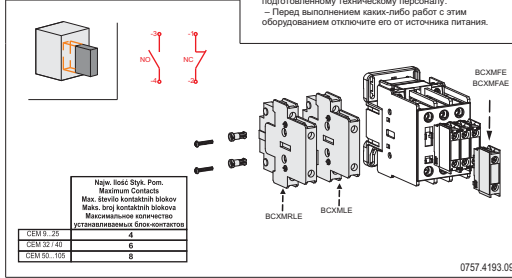
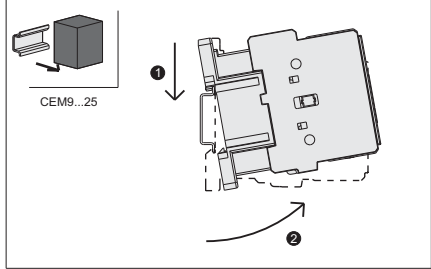
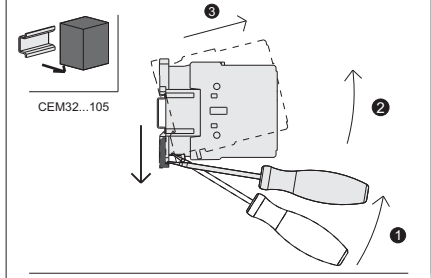
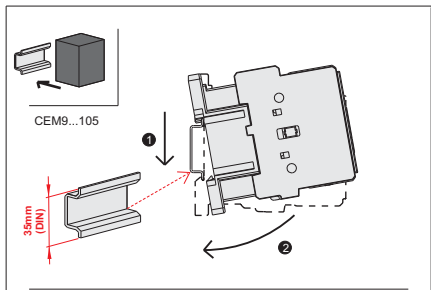
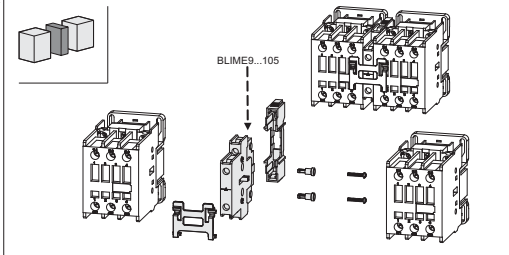
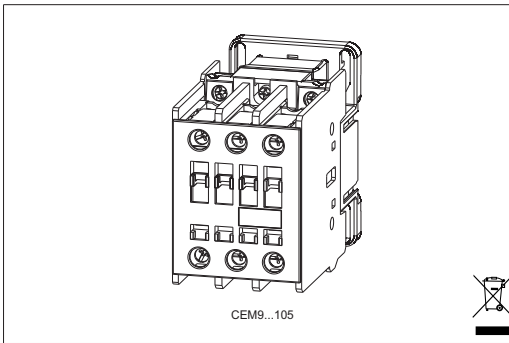

- Перед выполнением каких-либо работ с этим оборудованием отключите его от источника питания.







	Najve. štev. Styk. Pom. Maximum Contacts
CEM 9...25	4
CEM 32...40	6
CEM 90...105	6

Max. število kontaktnih blokov
Max. broj kontaktnih blokova
Максимальное количество устанавливаемых блоков контактов



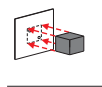

		CEM9...18			CEM25		
	mm ²	2X(0,5...2,5) 2X(2,5...6)	2X(1...2,5) 2X(2,5...6)	2X(0,5...2,5) 2X(2,5...6)	2X(1...2,5) 2X(2,5...10)	2X(1...2,5) 2X(2,5...10)	2X(1...2,5) 2X(2,5...10)
	AWG	2X(20...12) 2X(12...10)	2X(20...12) 2X(12...10)	2X(20...12) 2X(12...10)	2X(18...12) 2X(12...8)	2X(18...12) 2X(12...8)	2X(18...12) 2X(12...8)
	Nm / lb.in	1 ... 1,7 / 15			1,6 ... 3 / 16		

		CEM32...40			CEM50...80			CEM95...105		
	mm ²	1...16	1,5...16	1...16	2,5...35	6...35	2,5...35	4...35	6...35	4...35
	AWG	16...6			14...2			10...2		
	mm ²	0,75...16	1...16	0,75...16	1...35	1,5...35	1...35	1,5...50	2,5...50	1,5...50
	AWG	18...6			16...2			16...1		
	mm ²	1...16	1,5...16	1...16	2,5...35	6...35	2,5...35	4...35	6...35	4...35
	AWG	16...6			14...2			10...2		
	mm ²	0,75...16	1...16	0,75...16	1...35	1,5...35	1...35	1,5...50	2,5...50	1,5...50
	AWG	18...6			16...2			16...1		
	Nm / lb.in	2...2,5 / 22			4 ... 6 / 40			5 ... 6,5 / 60		

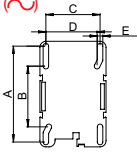

in
mm

		CEM32...40	
		A	3.110 79
		B	1.969 50
		C	1.772 45
		D	1.673 42.5
		E	0.179 4.5

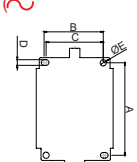
		CEM50...105	
		A	3.54 90
		B	2.24 57
		C	2.20 56
		D	0.22 5.5
		E	0.24 6

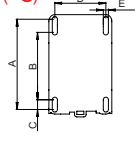

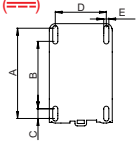

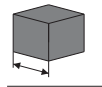

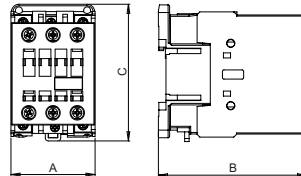

		CEM9...25	
		A	2.874 73
		B	2.291 58.2
		C	0.394 10
		D	1.378 35
		E	0.181 4.6

		CEM9...25	CEM32...40
		A	3.110 79
		B	2.323 59
		C	0.335 8.5
		D	1.772 45
		E	0.177 4.5



in
mm



	CEM9 CEM18 AC 	CEM9 CEM18 DC 	CEM25 AC 	CEM25 DC 	CEM32 CEM40 AC 	CEM32 CEM40 DC 	CEM50 CEM80 AC/DC 	CEM95 CEM105 AC/DC 
A	1.772 45	1.772 45	3.425 87	4.606 117	2.185 55.5	2.165 55	2.60 66	2.97 75.4
B	3.362 85.4	4.547 115.5	3.425 87	4.606 117	3.852 97.9	4.640 117.9	4.53 115	4.97 126.2
C	3.189 81	3.189 81	3.189 81	3.189 81	3.524 89.5	3.524 89.5	4.58 116.3	4.58 116.3

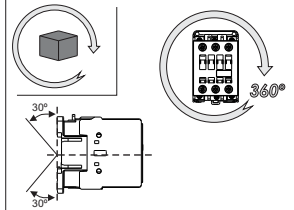

ETI

POLSKA
ETI Polam Sp. z o.o.
ul. Jana Pawła II 18
Tel. 0-48/ 23 691 93 00
Fax. 0-48/ 23 691 93 60
www.etipolam.com.pl

SLOVENIA
ETI Elektroelem d.o.o.
1411 Izlake
Obrezja 5
Phone: +386(0)356 57 570
Fax: +386(0)356 74 077
www.etigroup.eu