

RCCBs - Residual current circuit breakers EFI

Features of residual current circuit breakers EFI

→ Quality seal for tested reliability

→ Real contact position indication for easier contact status identification

→ Test button enables user to check residual functionality

→ Various quality marks

→ Rated conditional short-circuit current : 10 kA

→ AC - pure sinus residual current,
 → A - AC + pulsating direct current
 → B - AC + A + smooth direct current + high frequency (1kHz)
 → B+ - AC + A + smooth direct current + high frequency (20kHz)

→ Supply is possible both from top and bottom terminals

→ RCCBs can be supplied with single phase and three phase busbars

→ The terminals accept not only wires but also time saving busbars







Residual current circuit breakers can be used in TN-S, TN-CS, TT and IT network systems, or with other words, in all systems where neutral and protective conductors are separated. Residual current circuit breakers EFI are used for protection against indirect contact (fault protection) and direct contact (additional protection) of parts under voltage. In the case of protection against indirect contact (fault protection) you can use residual current protective devices with a rated residual current of $I_{\Delta n} \leq 300\text{mA}$. Residual current protective devices with a rated residual current of $I_{\Delta n} \leq 30\text{mA}$ fulfil the conditions for protection against direct contact (additional protection). For protection against fire, according to DIN VDE 0100-482 and IEC 60364-4-482, all cables and conductors in TN and TT systems must be protected by means of residual current protective devices with rated residual current of $I_{\Delta n} \leq 300\text{mA}$. In applications where resistive faults can cause a fire (radiant ceiling heating with panel heating elements), the rated residual current must be $I_{\Delta n} = 30\text{mA}$.













Types

- AC Type: they are sensitive to alternating (sinusoidal) AC residual currents.
- A Type: they are sensitive to alternating (sinusoidal) AC residual currents and pulsating DC residual currents.
- B Type: they are sensitive to alternating (sinusoidal) AC residual currents, pulsating DC residual currents and smooth DC residual currents. Tripping values are defined up to 1kHz.
- B+ Type: they are sensitive to alternating (sinusoidal) AC residual currents, pulsating DC residual currents and smooth DC residual currents. Tripping values are defined up to 20kHz and they are below 420mA.









Classification regarding break time

- Instantaneous: max. break time 40ms (Inst.)
- K-Short time delay: time delayed min. 10ms and max. 40ms (K)
- S-Selective: time delayed min. 40ms and max. 150ms (S)

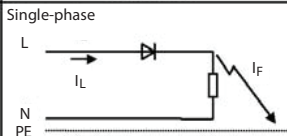
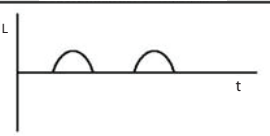
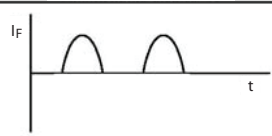
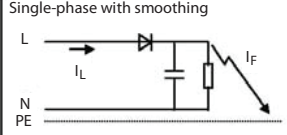
EFI 2 (2M)		Type AC Inst.	Type A Inst.	K	S
	For alternating residual current	✓	✓	✓	✓
	For alternating and pulsating direct residual current		✓	✓	✓
 10.000	Short-circuit capacity with back-up fuse	✓	✓	✓	✓
	Lower temperature limit of application -25°C	✓	✓	✓	✓
	VDE 0664, part 1 (up to 80 A)		✓		✓
	Short time delayed (10 - 40 ms)			✓	
	Selective (time delayed 40 -150 ms)				✓

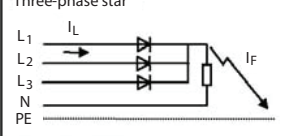
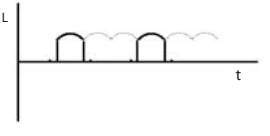
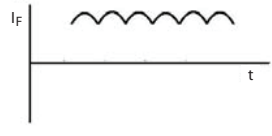
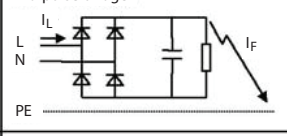
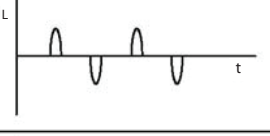
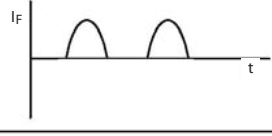
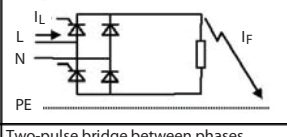
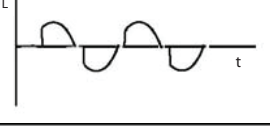
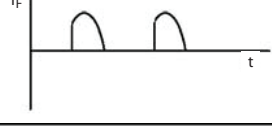
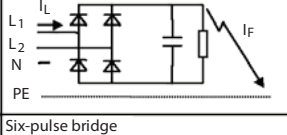
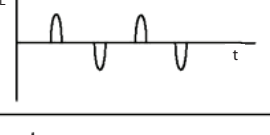
EFI 4 (4M)		Type AC Inst.	Type A Inst.	K	S	Type B Inst.	K	S	Type B+ Inst.	K	S
	For alternating residual current	✓	✓	✓	✓	✓	✓	✓	✓	✓	✓
	For alternating and pulsating direct residual current		✓	✓	✓	✓	✓	✓	✓	✓	✓
  	For alternating, pulsating direct and smooth DC residual current (up to 1kHz)					✓	✓	✓	✓	✓	✓
  kHz	For alternating, pulsating direct and smooth DC residual current (up to 20kHz)								✓	✓	✓
 10.000	Short-circuit capacity with back-up fuse	✓	✓	✓	✓	✓	✓	✓	✓	✓	✓
	Lower temperature limit of application -25°C	✓	✓	✓	✓	✓	✓	✓	✓	✓	✓
	VDE 0664, part 1 (up to 80 A)		✓		✓	✓		✓	✓		✓
	Short time delayed (10 - 40 ms)			✓			✓			✓	
	Selective (time delayed 40 -150 ms)				✓			✓			✓

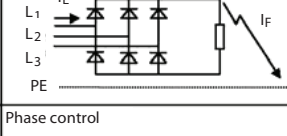
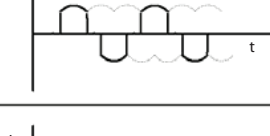
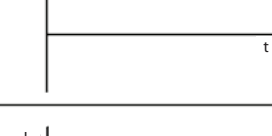
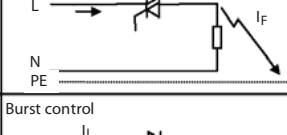
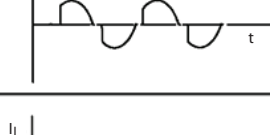
Use of AC, A, and B type of RCCB's in case of different fault conditions

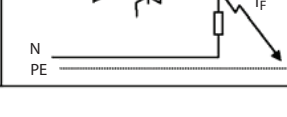
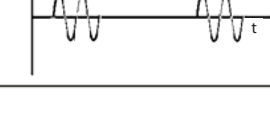
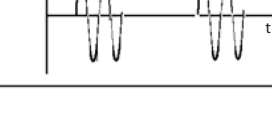
			AC	A	B, B+
Connection					
		Normal mains current			
1	Single-phase 			<input type="checkbox"/>	<input checked="" type="checkbox"/>
2	Single-phase with smoothing 			<input type="checkbox"/>	<input checked="" type="checkbox"/>
3	Three-phase star 			<input type="checkbox"/>	<input checked="" type="checkbox"/>
4	Two-pulse bridge 			<input checked="" type="checkbox"/>	<input checked="" type="checkbox"/>
5	Two-pulse bridge, half-controlled 			<input checked="" type="checkbox"/>	<input checked="" type="checkbox"/>
6	Two-pulse bridge between phases 			<input checked="" type="checkbox"/>	<input checked="" type="checkbox"/>
7	Six-pulse bridge 			<input type="checkbox"/>	<input checked="" type="checkbox"/>
8	Phase control 			<input checked="" type="checkbox"/>	<input checked="" type="checkbox"/>
9	Burst control 			<input checked="" type="checkbox"/>	<input checked="" type="checkbox"/>

Residual current circuit breaker EFI-2

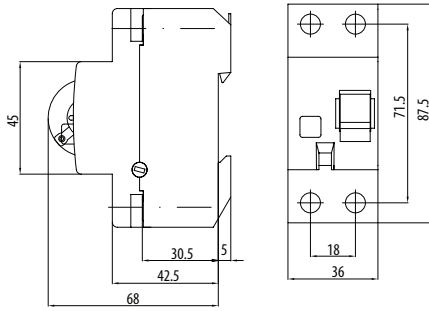

EFI-2 16-80 A

Technical data	
Rated voltage U_n	230 V AC
Rated current I_n	16, 25, 40, 63, 80, 100 A
Rated residual current $I_{\Delta n}$	0.03, 0.1, 0.3, 0.5 A
Conditional short-circuit current	10 kA
Rated making and breaking capacity I_m	800 A
Back-up fuse	100 A gG
Degree of protection	IP 20 (IP40)
Insulating class	B
Cross-section of connecting lead	1 - 25 mm ² (1-35 mm ² - 100 A)
Standards	EN 61008, IEC 61008,

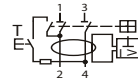

EFI-2 100 A

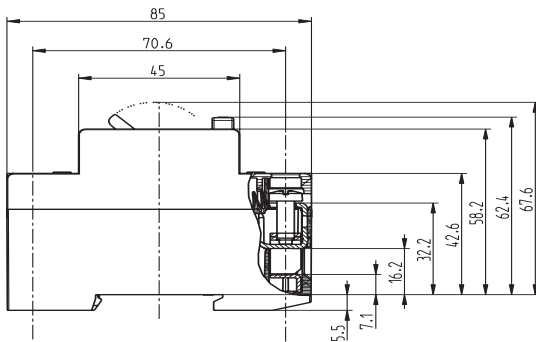

EFI-2 100 A

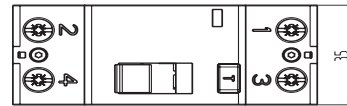

EFI-2 100 A

Residual current circuit breaker EFI-4

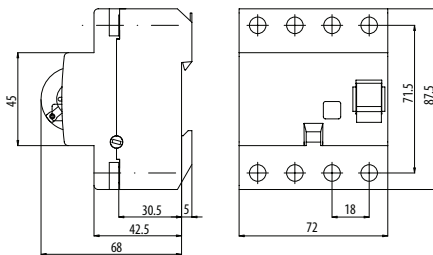

EFI-4 16-80 A

Technical data	
Rated voltage U_n	230/400 V AC
Rated current I_n	16, 25, 40, 63, 80, 100 A
Rated residual current $I_{\Delta n}$	0,03, 0,1, 0,3, 0,5 A
Conditional short-circuit current	10 kA
Rated making and breaking capacity I_m	800 A
Back-up fuse	100 A gG
Degree of protection	IP20 (IP40)
Insulating class	B
Cross-section of connecting lead	1 - 25 mm ² (1-35 mm ² - 100 A)
Standard	EN 61008, IEC 61008

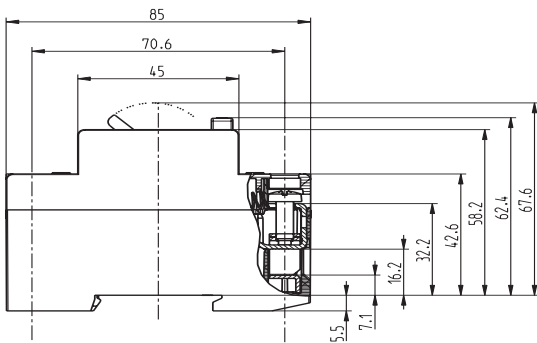

EFI-4 100 A

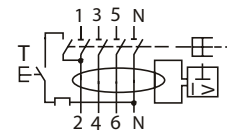
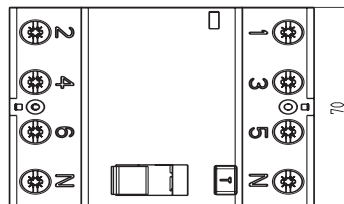

Auxiliary switch PS EFI

The PS EFI is fixed to EFI series switches. The width of the device is 9 mm, other dimensions are in compliance with EFI switches. The auxiliary switch PS EFI is used for the remote signalling of the state of contact's condition (closed/open) of EFI switches. During fitting, the EFI must be switched off.

Technical data	
Rated current I_n	6 A (230 V AC), AC 12, 1 A (110 V DC), DC 12
Conditional short-circuit current	1 kA with fuse-link 20 A
Standards	EN 62019

