

NEW ETIMAT P10

High breaking capacity MCB ETIMAT P10



→ Supply possibility:

- top
- bottom

- Double connection possibility
- Every product is marked with EAN Code



→ New method of mounting on the DIN rail and simple replacement

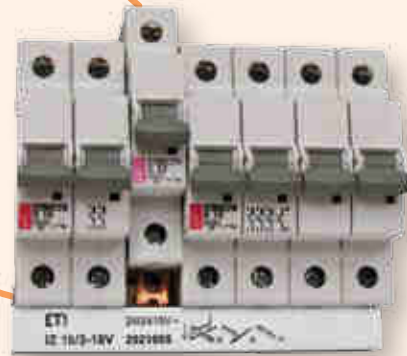

→ Totally renewed, these products replace the ETIMAT 11 series and perfectly integrate with the ASTI product range, starting with identical profile which lends to a coordinated and streamlined look to the installation.

PREMIUM PERFORMANCE MCB
 PRODUCT PERFORMANCE & AUXILIARY
 PRODUCT QUALITY & RELIABILITY
 POWER CONTROL
 PRICE AVAILABILITY

Miniature circuit breakers

Other features

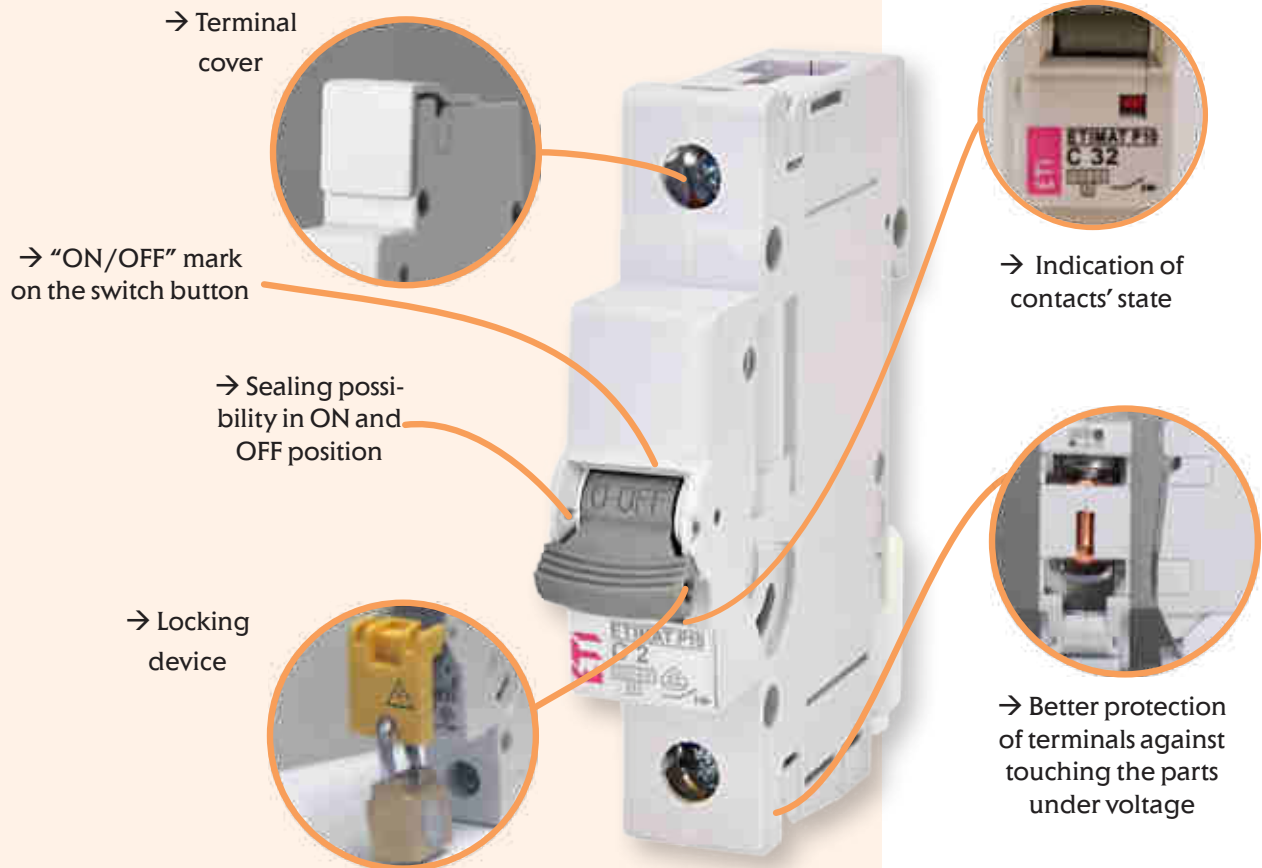

ETIMAT RC - Remote control

ETIMAT RC is a miniature circuit breaker with remote control mechanism. ETIMAT RC provides following advantages:

- remote switching with simultaneous protection
- minimal space requirement
- straightforward actuation
- can be used as actuator in any installation bus system
- secure against remote activation after manual switch-of and/or being tripped by overcurrent
- control coil protected against thermal overload
- easy installation assured by rapid fastening method
- visual status display : red/ON, green/OFF
- sealable control lever
- capability of adding an auxiliary switch

Technical Data:

- the remote control mechanism, which serves to actuate ETIMAT RC is connected to MCB ETIMAT 11 by the factory before dispatch
- the remote control mechanism is activated electromagnetically by the application of a control voltage acc. to following data:
- rated voltage: 230V a.c.
- exciting current: approx 1.5A, duration min 20msek
- No. of operations: 20.000 , max 4 per minute



Miniature circuit breaker ETIMAT P10

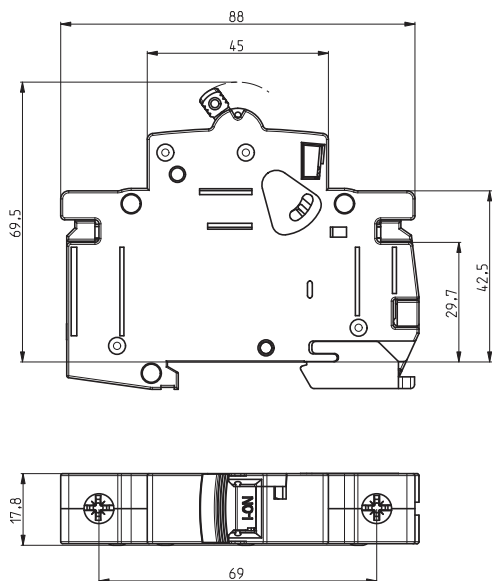

Technical data

Rated voltage	230/400 V AC; max. 60 V DC / pole
Rated current	B:1-63A, C:0.5-63A, D:0.5-32A, K, Z:0.5-32A
Rated frequency	50/60Hz
Shock resistance	30g.min. 2 shocks, t = 13ms
Rated short-circuit capacity	10 kA
Energy limiting class	3; B,C
Tripping characteristic	B, C, D, K, Z
Back-up fuse	100A gG
Index of protection	IP 20 (IP 40)
Terminals	1-25mm ² , max. 2,5Nm
Terminal screw	M5 (Poqidrive PZ2)
Mechanical endurance	20000 op.c.
Electrical endurance	20000 op.c. (I _n ≤ 32A), 10000 op.c. (I _n > 32A)
Ambient temperature	max. -25°C ... +55°C
Storage temperature	max. -40°C ... +70°C
Supply possibility	top or bottom
Build-in width	18 mm/pol
Insulating class	B
Overvoltage category	III
Mounting on the rail	EN 60715
Mounting position	any
Sealing possibility	✓
Terminal cover	✓
Locking device	✓
Resistance to vibrations acc. to IEC 60068-2-7	5g (10,60 & 500Hz)
Standards	EN 60898, IEC 60898, IEC 60947-2

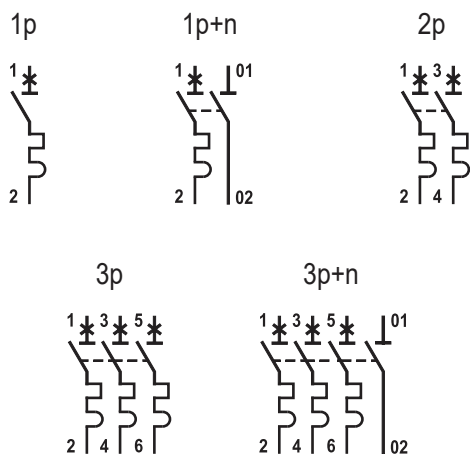

Tripping characteristics

Characteristic	Test current	Tripping time	Result
B, C, D	1,13 I _n	t ≥ 3600 s	No tripping
B, C, D	1,45 I _n	t < 3600 s	Tripping
B, C, D	2,55 I _n	1s < t < 60 s	Tripping
B	3,00 I _n	t ≤ 0,1 s	No tripping
C	5,00 I _n	t ≤ 0,1 s	No tripping
D	10,00 I _n	t ≤ 0,1 s	No tripping
B	5,00 I _n	t < 0,1 s	Tripping
C	10,00 I _n	t < 0,1 s	Tripping
D	20,00 I _n	t < 0,1 s	Tripping
K	1,05 I _n	t > 7200 s	No Tripping
K	1,20 I _n	t < 7200 s	Tripping
K	8,00 I _n	t ≤ 0,2 s	No Tripping
K	12,00 I _n	t < 0,2 s	Tripping
Z	2,00 I _n	t ≤ 0,2s	No Tripping
Z	3,00 I _n	t < 0,2s	Tripping

Technical data

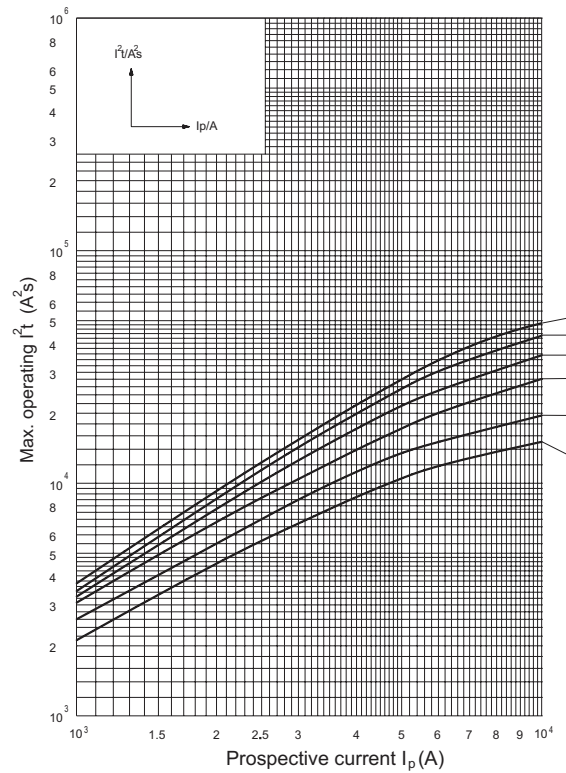
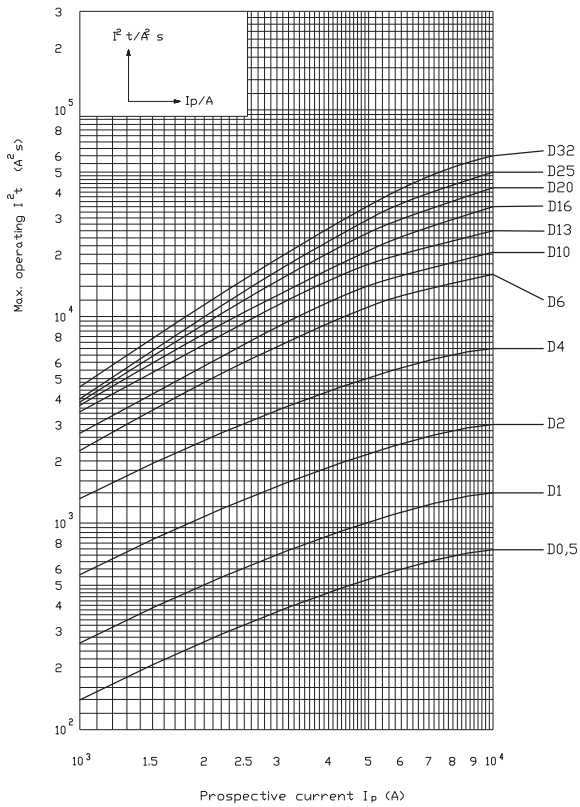
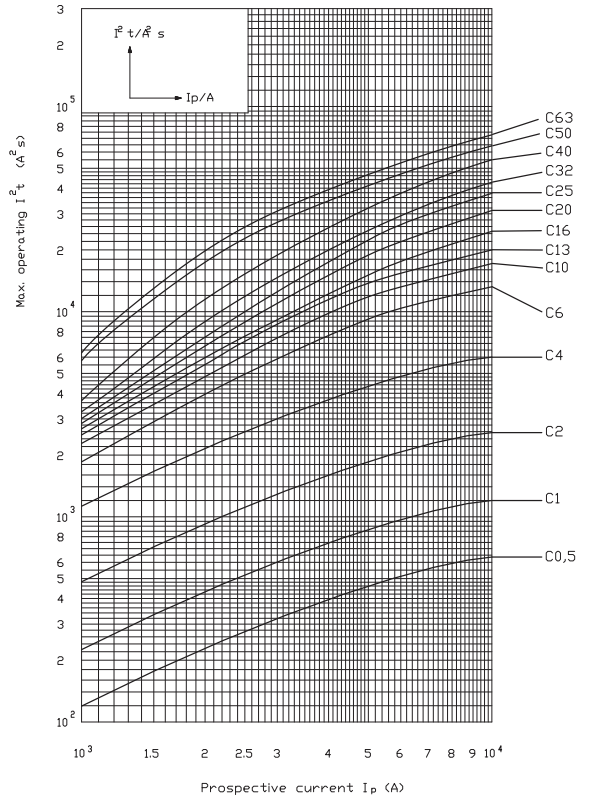
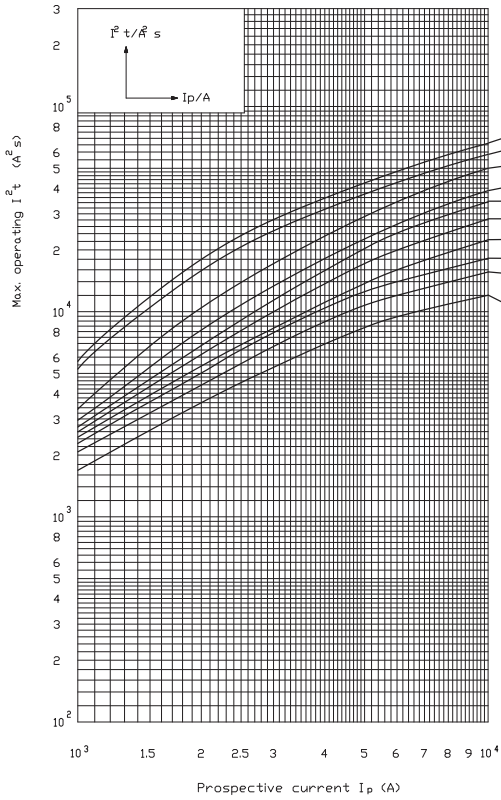

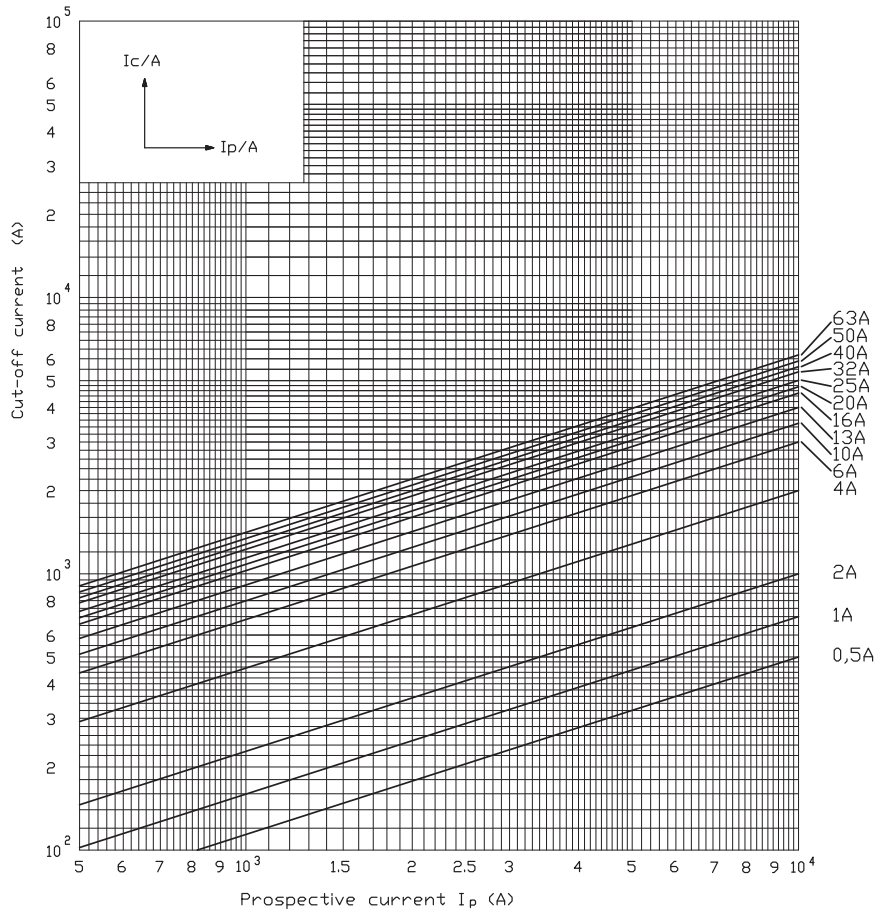

I/t characteristic at 50 and 60Hz

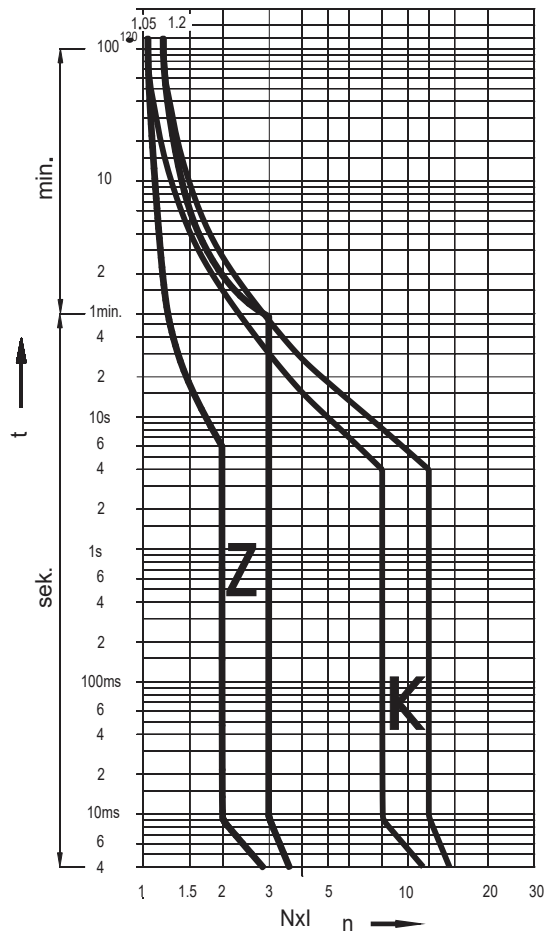
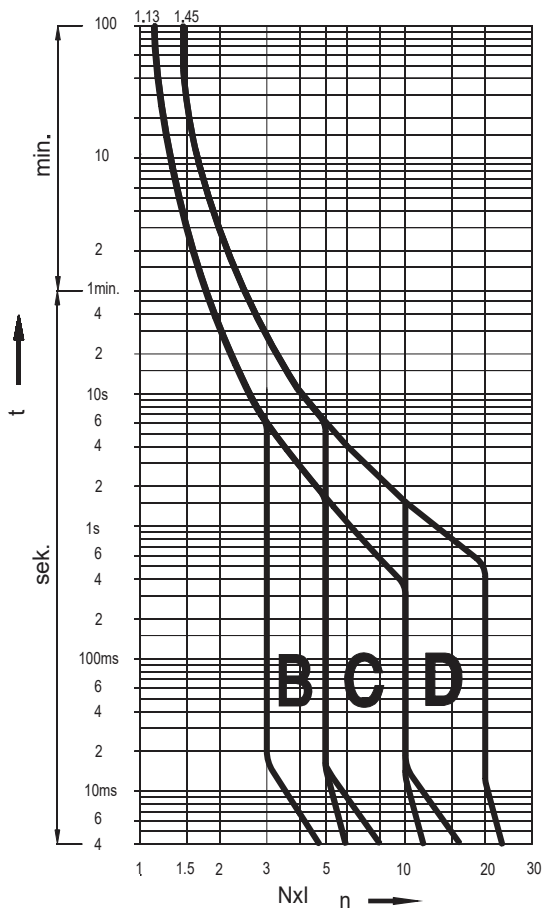

Effect of the ambient temperature on the tripping characteristic

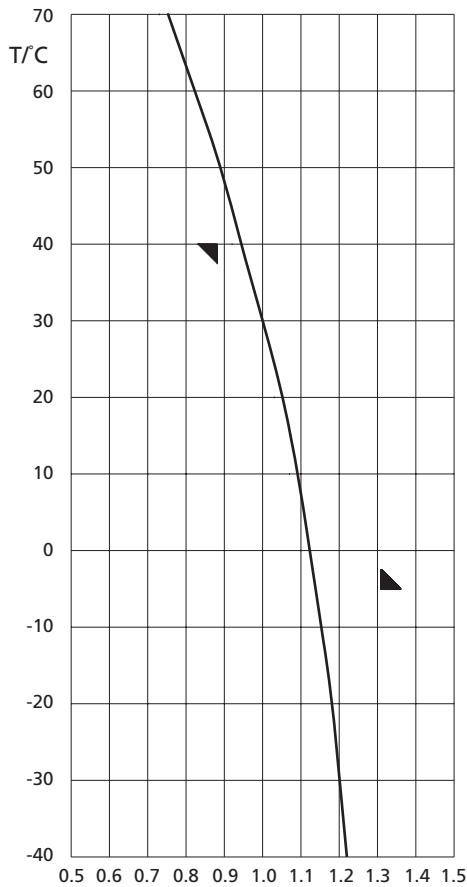

Correction factor is valid for current with times over 30 s
 $I(x^{\circ}C)$ - test current at x ambient temperature
 $I(30^{\circ}C)$ - test current at 30°C ambient temperature

$$k = \frac{I(x^{\circ}C)}{I(30^{\circ}C)}$$

I_n [A]	Ambient temperature $T/^{\circ}C$											
	-40	-30	-20	-10	0	10	20	30	40	50	60	70
0,5	0,61	0,6	0,59	0,57	0,56	0,54	0,52	0,5	0,47	0,44	0,41	0,38
1	1,22	1,2	1,18	1,15	1,12	1,09	1,05	1	0,94	0,88	0,82	0,75
1,6	1,95	1,92	1,89	1,84	1,79	1,74	1,68	1,6	1,51	1,42	1,32	1,2
2	2,44	2,4	2,36	2,30	2,24	2,18	2,1	2	1,88	1,77	1,65	1,5
4	4,88	4,8	4,72	4,61	4,49	4,36	4,20	4	3,77	3,55	3,29	3
6	7,32	7,2	7,09	6,91	6,73	6,54	6,31	6	5,66	5,33	4,94	4,5
10	12,2	12	11,8	11,5	11,2	10,9	10,5	10	9,44	8,89	8,23	7,5
13	15,9	15,6	15,4	14,9	14,5	14,1	13,6	13	12,2	11,5	10,7	9,75
16	19,5	19,2	18,9	18,4	17,9	17,4	16,8	16	15,1	14,2	13,2	12
20	24,4	24	23,6	23	22,4	21,8	21	21	18,8	17,7	16,5	15
25	30,5	30	2,5	28,8	28	27,2	26,3	25	23,6	22,2	20,6	18,8
32	39	38,4	37,8	36,9	35,9	34,9	33,6	32	30,2	28,4	26,3	24
40	48,8	48	47,8	46,1	44,9	43,6	42	40	37,7	35,5	32,9	30
50	61	60	59,1	57,6	56,1	54,5	52,6	50	47,2	44,4	41,2	37,5
63	76,9	75,6	74,4	72,6	70,7	68,7	66,2	63	59,4	56	51,9	47,3

Conductor cross-section [mm ²]	Number of single conductors, rigid, single-wire CU conductor				
	1	2	3	4	5
1,5	✓	✓	✓	✓	✗
2,5	✓	✓	✓	✗	✗
4	✓	✓	✓	✗	✗
6	✓	✓	✗	✗	✗
10	✓	✓	✗	✗	✗
16	✓	✗	✗	✗	✗
25	✓	✗	✗	✗	✗

Remark: When you use more than 2 cables you have to be careful how those cables are inserted, due to insure proper pressure on each cable

Conductor cross-section [mm ²]	Number of single conductors, flexible Cu conductors without cable ferrule					
	1	2	3	4	5	6
1,5	✓	✓	✓	✓	✓	✓
2,5	✓	✓	✓	✓	✓	✓
4	✓	✓	✓	✓	✓	✓
6	✓	✓	✓	✗	✗	✗
10	✓	✓	✗	✗	✗	✗
16	✓	✗	✗	✗	✗	✗
25	✓	✗	✗	✗	✗	✗

Combination of rigid single-wire and flexible multi-wire Cu conductors is not allowed

Resistance and power loss

characteristic	I _n [A]	R/pole [mΩ]	P/pole [w]
C, D, K, Z	0,5	5700	1,43
	1	1540	1,54
	2	365	1,46
	4	104	1,66
B, C, D, K, Z	6	47	1,68
	10	21	2,1
	13	13,1	2,21
	16	9,7	2,48
	20	6,8	2,70
	25	5,0	3,13
B, C	32	3,1	3,2
	40	2,4	3,80
	50	1,7	4,25
	63	1,23	4,90

Selectivity

type	gG NV [kA]										
	20	25	32	35	40	50	63	80	100	125	160
B 6	0,5	0,78	1,2	1,4	1,7	2,4	4,6	7,0	10	10	10
B 10/13	0,45	0,65	1,1	1,3	1,6	2,2	4,0	6,5	10	10	10
B 16		0,55	1,0	1,2	1,5	2,0	3,6	5,5	9,5	10	10
B 20			0,85	1,2	1,5	1,8	3,1	4,6	9,0	10	10
B 25				1,1	1,4	1,7	2,9	4,0	8,0	10	10
B 32					1,3	1,6	2,5	3,4	5,5	9,0	10
B 40						1,5	2,2	3,1	4,9	8,0	10
B 50							2,1	2,9	4,0	6,2	10
B 63								2,5	3,3	5,1	8,0

type	gG NV [kA]										
	20	25	32	35	40	50	63	80	100	125	160
C,D,K,Z 6	0,52	0,82	1,3	1,5	2,0	2,7	5,1	9,0	10	10	10
C,D,K,Z 10/13	0,47	0,70	1,1	1,4	1,8	2,3	4,0	7,0	10	10	10
C,D,K,Z 16		0,61	0,92	1,2	1,5	1,9	3,2	5,0	9,0	10	10
C,D,K,Z 20			0,90	1,1	1,4	1,7	2,9	4,2	8,0	10	10
C,D,K,Z 25				1,0	1,3	1,6	2,7	3,9	6,0	10	10
C,D,K,Z 32					1,2	1,5	2,3	3,4	5,2	9,0	10
C 40						1,4	2,1	3,0	4,6	8,0	10
C 50							2,0	2,7	3,8	7,0	10
C 63								2,3	3,2	5,5	9,0

Miniature circuit breaker ETIMAT P10 QC (screwless terminal)

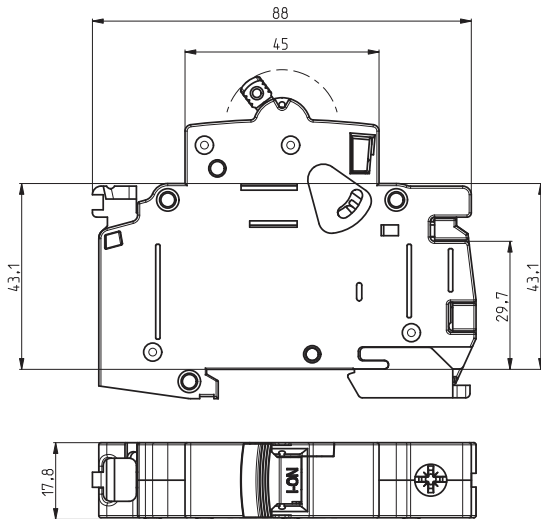

Technical data	
Rated voltage	230/400 V AC; max. 60 V DC
Rated current	B:6-20A, C:0.5-20A, D:0.5-20A, K:0.5-20A
Rated frequency	50/60Hz
Shock resistance	30g.min. 2 shocks, t = 13ms
Rated short-circuit capacity	10 kA
Energy limiting class	3; B,C
Tripping characteristic	B, C, D, K
Back-up fuse	100A gG
Index of protection	IP 20 (IP 40)
Terminals	1-4mm ²
Mechanical endurance	20000 op.c.
Electrical endurance	20000 op.c.
Ambient temperature	max. -25°C to +55°C
Storage temperature	max. -40°C to +70°C
Build-in width	18 mm/pol
Insulating class	B
Mounting on the rail	EN 60715
Mounting position	any
Sealing possibility	✓
Terminal cover	✓
Locking device	✓
Resistance to vibrations acc. to IEC 60068-2-7	5g (10,60 & 500Hz)
Standards	EN 60898, IEC 60898, EN 60947-2

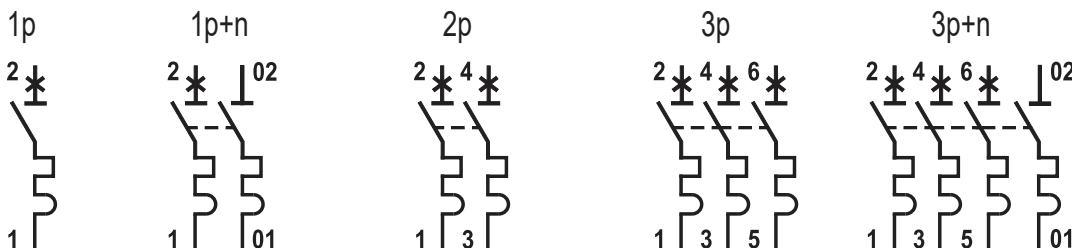

Technical data

Miniature circuit breaker ETIMAT RC (Remote Control)

Technical data	
Rated voltage	230V
Rated current	B: 6-63 A, C: 6-63 A
Rated frequency	50/60Hz
Energy limiting class	3
Back-up fuse	100 A gG
Index of protection	IP 20 (IP 40)
Terminals	max. 1.5mm ² , max. 0.8Nm
Mech. / electrical endurance	20000 op.c., max 4/min
Ambient temperature	max. 35°C
Storage temperature	max. -40°C... +70°C
Mounting on the rail	EN 60715
Mounting position	any
Sealing possibility	✓
Terminal cover	✓
Locking device	✓
No. of poles	1, 2, 3, 4

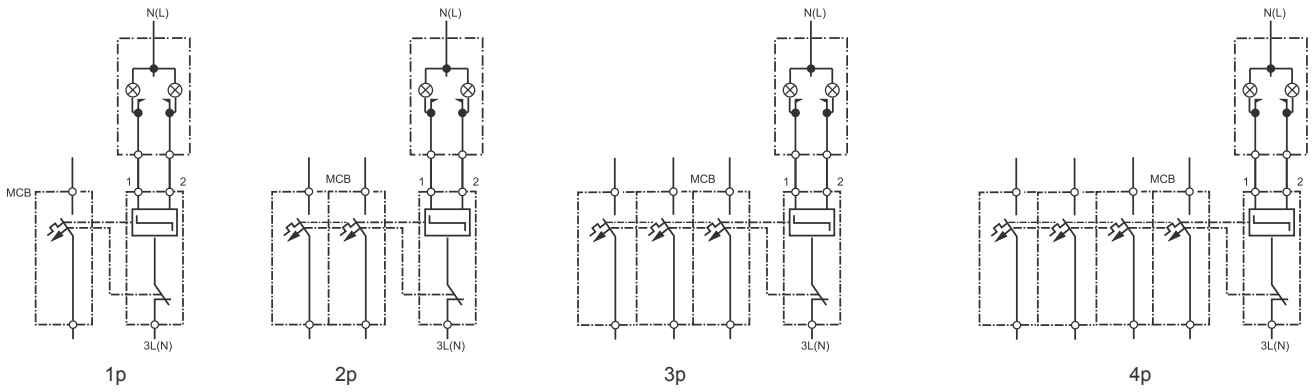
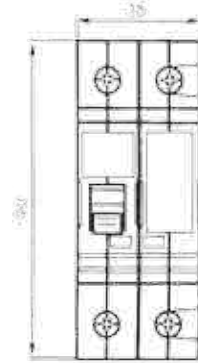

Conductor cross-section [mm ²]	Number of single conductors, rigid, single-wire Cu conductor				
	1	2	3	4	5
1,5	✓	✓	✓	✓	✗
2,5	✓	✓	✓	✗	✗
4	✓	✓	✓	✗	✗
6	✓	✓	✗	✗	✗
10	✓	✓	✗	✗	✗
16	✓	✗	✗	✗	✗
25	✓	✗	✗	✗	✗

Remark: When you use more than 2 cables you have to be careful how those cables are inserted, due to insure proper pressure on each cable

Conductor cross-section [mm ²]	Number of single conductors, flexible Cu conductors without cable ferrule					
	1	2	3	4	5	6
1,5	✓	✓	✓	✓	✓	✓
2,5	✓	✓	✓	✓	✓	✓
4	✓	✓	✓	✓	✓	✓
6	✓	✓	✓	✗	✗	✗
10	✓	✓	✗	✗	✗	✗
16	✓	✗	✗	✗	✗	✗
25	✓	✗	✗	✗	✗	✗

Combination of rigid single-wire and flexible multi-wire Cu conductors is not allowed

Miniature circuit breaker ETIMAT P10 DC

Technical data

Rated voltage - for 1-pole U_n	220 V DC
- for 2-pole U_n	220 V / 440 V DC
Rated time constant L/R	4 ms
Rated current I_n	0,5-32A (K & Z), 0,5-63A (C), 2-63A (B)
Rated short-circuit capacity	10 kA
Tripping characteristic	B, C, K, Z
Energy limiting class	3
Insulating class	B
Back-up fuse	100 A gG
Terminals	1-25mm ² , max. 2,5Nm
Terminal screw	M5 (Pozidrive PZ2)
Mounting position	any
Resistance to vibrations (IEC 60068-2-7)	5g (10,60 & 500Hz)
Standards	IEC 60898, EN 60898, DIN VDE 0641

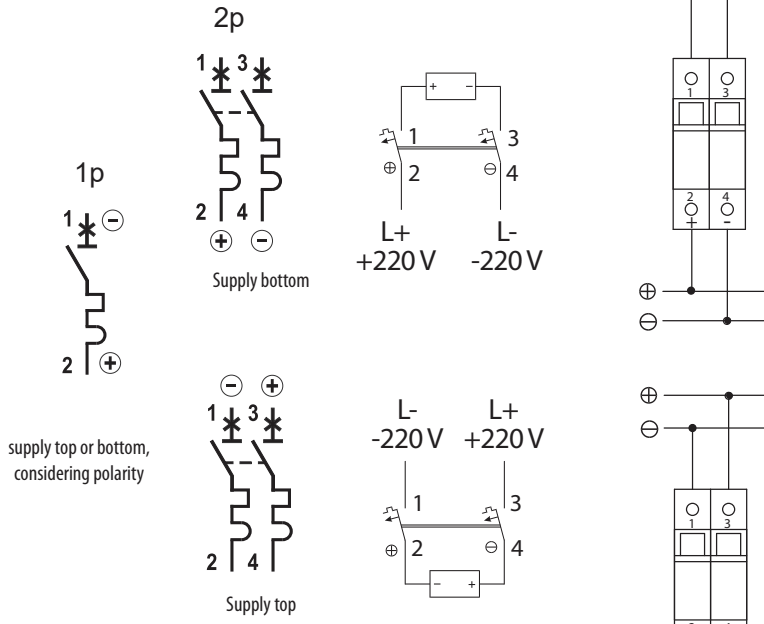

Connecting diagrams in direct current electric circuits

Rated voltage of circuit breaker	220 V ---	220/440 V ---	220/440 V ---	220/440 V ---
Voltage between conductors - max.	220 V ---	440 V ---	440 V ---	440 V ---
Voltage between conductor and earth - max.	220 V ---	220 V ---	440 V ---	220 V ---
Circuit breaker	1-pole	2-pole	2-pole	2-pole
Connecting diagram				

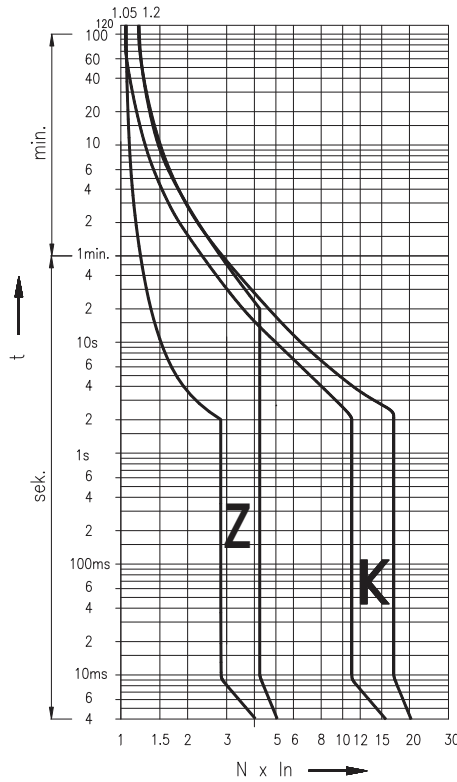
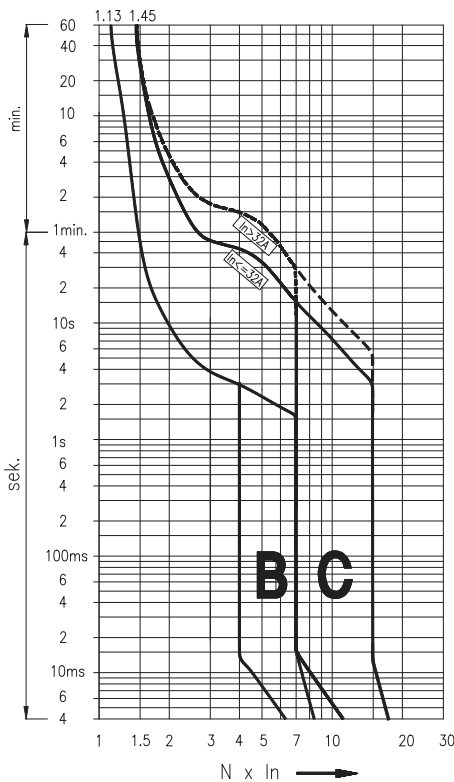

Conductor cross-section [mm ²]	Number of single conductors, rigid, single-wire CU conductor				
	1	2	3	4	5
1,5	✓	✓	✓	✓	✗
2,5	✓	✓	✓	✗	✗
4	✓	✓	✓	✗	✗
6	✓	✓	✗	✗	✗
10	✓	✓	✗	✗	✗
16	✓	✗	✗	✗	✗
25	✓	✗	✗	✗	✗

Remark: When you use more than 2 cables you have to be careful how those cables are inserted, due to insure proper pressure on each cable

Conductor cross-section [mm ²]	Number of single conductors, flexible Cu conductors without cable ferrule					
	1	2	3	4	5	6
1,5	✓	✓	✓	✓	✓	✓
2,5	✓	✓	✓	✓	✓	✓
4	✓	✓	✓	✓	✓	✓
6	✓	✓	✓	✗	✗	✗
10	✓	✓	✗	✗	✗	✗
16	✓	✗	✗	✗	✗	✗
25	✓	✗	✗	✗	✗	✗

Combination of rigid single-wire and flexible multi-wire Cu conductors is not allowed

Technical data

Auxiliary signal switch PS/SS E P10

Technical data	
Function	Auxiliary or Signal Switch
Rated voltage	230V AC/DC, 110V DC
Rated current	6A (230V AC); 1A (110V DC); 0,5A (220V DC)
Rated frequency	50/60Hz, DC
Index of protection	IP 20 (IP 40)
Terminal capacity	1,5mm ²
Terminal Screw	M3 PH1
Terminal torque	max 0,5Nm
Ambient temperature	-25°C to +40°C
Storage temperature	-40°C to +70°C
Contacts	1x NC, 1x NC/NO
Mounting position	any
Standards	EN 62019

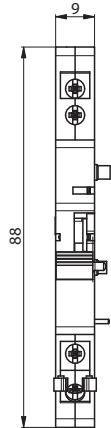

AUX switch connections	status of the breaker	
	ON	OFF
11-14 NO	1	0
11-12 NC	0	1
21-22 NC	0	1

Signal switch connections	status of the breaker		
	ON	manual trip	overcurrent trip
11-14 NO	1	1	0
11-12 NC	0	0	1
21-22 NC	0	0	1

NO - Normally open contact --> during the activation it makes a contact
 NC - Normally closed contact --> during the activation it brakes the contact
 1 - contact
 0 - without a contact

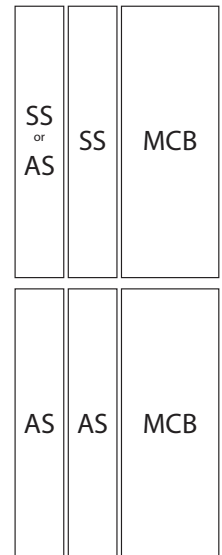
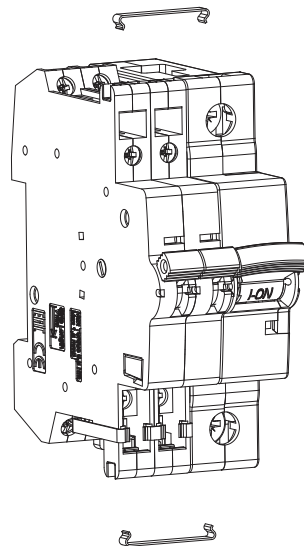

Shunt trip release DA ETIMAT P10

Technical data	
Rated voltage	12-60V AC/DC, 110-250V AC/DC
Rated frequency	50/60Hz, DC
Max inrush current	3A
Index of protection	IP 20 (IP 40)
Terminals	1-25mm ² , max. 2,5Nm
Ambient temperature	M5 (Pozidrive PZ2)
Terminal screw	max. 35°C
Storage temperature	max. -40°C to +70°C
Mounting on the rail	EN 60715
Mounting position	any
Sealing possibility	✓
Terminal cover	✓
Locking device	✓

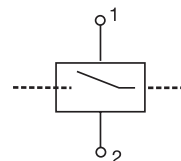

Note: Same dimensions as ETIMAT P10

Undervoltage release UA ETIMAT P10

Technical data		
Type	UA ETIMAT P10/48V	UA ETIMAT P10/230V
Rated voltage	48V	230V
Rated frequency	50/60Hz	
Tripping area	<math>< 35\% U_n</math> tripping 35%-70% U_n tripping or no tripping >70% U_n no tripping	
Consumption	3,8 VA	
Build-in width	18 mm	
Mounting position	any	
Standards	IEC/EN 60947-1	

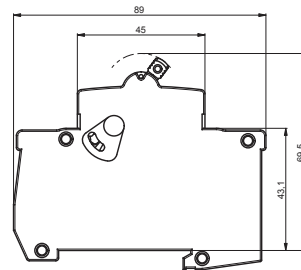

1p

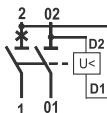

3p

