

PCE data sheet

article#	2832-10v
article description	CEE-connector 16A 3p 24/42VDC IP67 TWIST
description long	CEE-connector 16A 3p 24/42VDC IP67 TWIST housing material: PA6 rated current: 16A number of poles: 3 (3P) clock-position: 10h rated voltage/frequency: 24/42V DC contacts: brass nickel plated connection technology: screw terminals IP protection class: IP67
GTIN (EAN)	9003399615979
country of origin	AT
customs number	85366990
net weight	0.214 kg
packaging quantity	10
minimum order quantity	10

ETIM 7.0	EC001320
IEC-amperage	16 A
Number of poles	3
Voltage acc. EN 60309-2	<50 V DC grey
Clock hour position	10 h
Degree of protection (IP)	IP67
Connection system	Schraubklemme
Angle of plug	Straight
Cable entry	Verschraubung
Material	Plastic

a	150 mm
b	78 mm
K (cable Ø)	9,5-24 mm
SW	48 mm
wire flexible	1-10 mm ²
contact screws	160 Ncm
strain relief	600 Ncm
dismantling length	70 mm
stripping length	14-16 mm

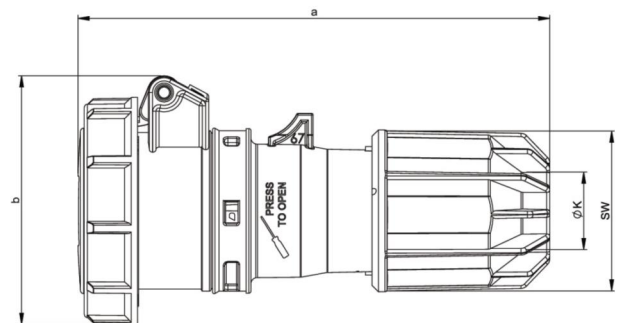

www.manufacturer-safety.info