

PCE data sheet

article#	3172-6v
article description	CEE-flanged socket (75x75mm) 16A 7p 6h IP66/IP67
description long	CEE-flanged socket (75x75mm) 16A 7p 6h IP66/IP67 housing material: PA6 rated current: 16A number of poles: 7 (6P+PE) clock-position: 6h rated voltage/frequency: 380-415V~ / 50+60Hz contacts: brass nickel plated connection technology: screw terminals dimensions (flange/fixing center): 75x75 mm / 60x60 mm IP protection class: IP66/IP67
GTIN (EAN)	9003399331145
country of origin	AT
customs number	85366990
net weight	0.211 kg
packaging quantity	10

ETIM 7.0	EC001317
IEC-amperage	16 A
Voltage acc. EN 60309-2	400 V (50+60 Hz) red
Number of poles	7
Clock hour position	6 h
Identification colour	Red
Degree of protection (IP)	IP67
Connection system	Schraubklemme
Angle of plug	Straight
Material	Plastic
Flange size vertical	75 mm
Drill hole distance vertical	60 mm
Flange size horizontal	75 mm
Drill hole distance horizontal	60 mm

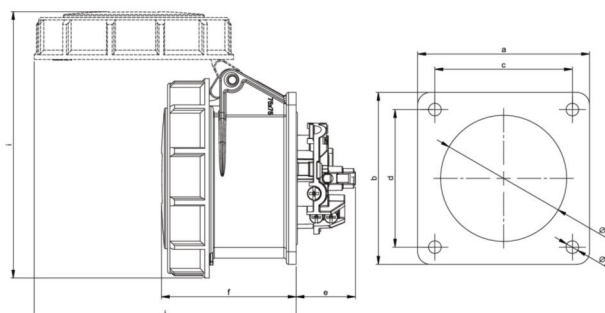
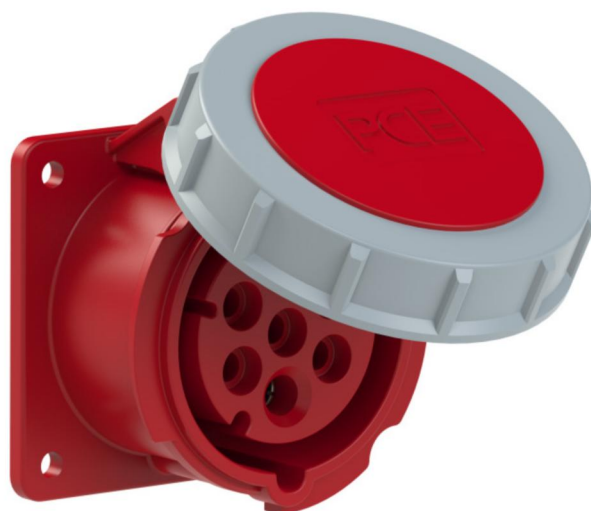

www.manufacturer-safety.info