

front

back

**PHILIPS**



Zarpy

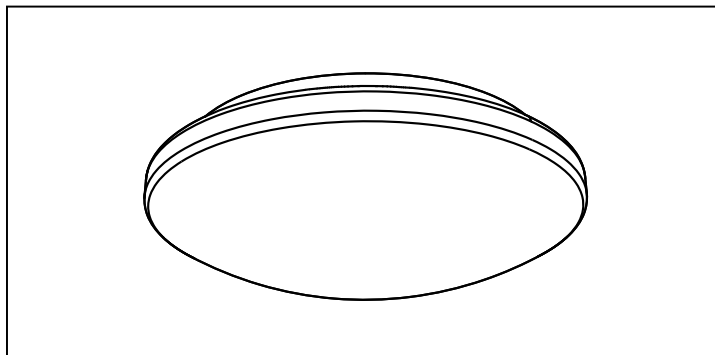
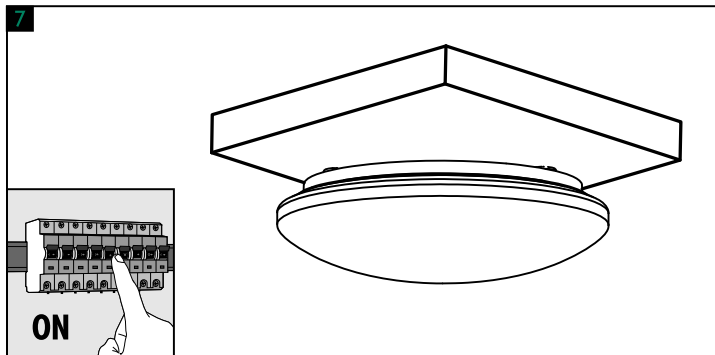
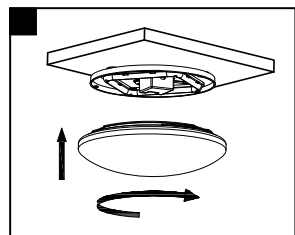
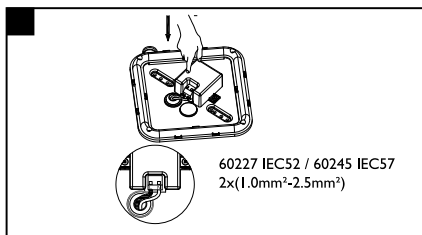
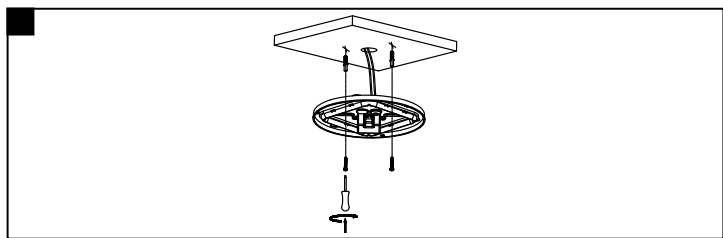
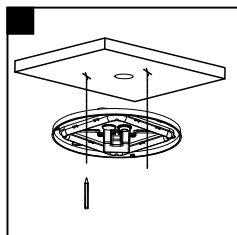
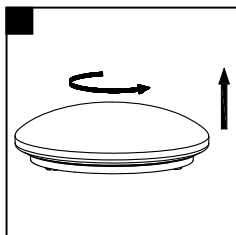
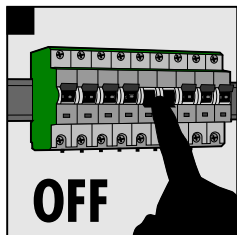
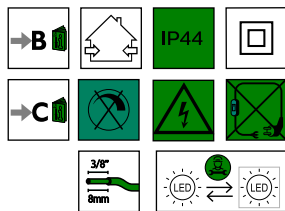

9290022094 9290022095

Philips and the Philips shield emblem are registered trademarks of Koninklijke Philips N.V.

Signify  
I.B.R.S. / C.C.R.I. Numéro 10461  
5600 VB Eindhoven, the Netherlands  
www.philips.com/lighting

© 2021 Signify Holding  
@signify

Signify Commercial UK Limited  
Unit 3, Guildford Business Park,  
Guildford, Surrey, GU2 8XG, UK



3241 653 91704  
Last update: 12/04/21

size: 105mmx148mm