

PHILIPS

hue personal
wireless
lighting

Impress



HUE serial number



User manual
Benutzerhandbuch
Notice d'emploi
Manual de usuario
Manual do usuário
Manuale d'uso

Incl.

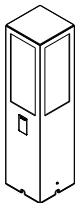

Excl.

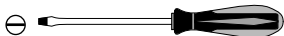
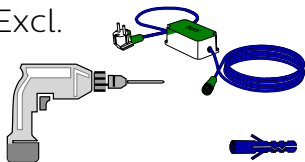

B

IP44



MAX. 40 W

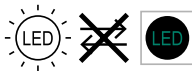

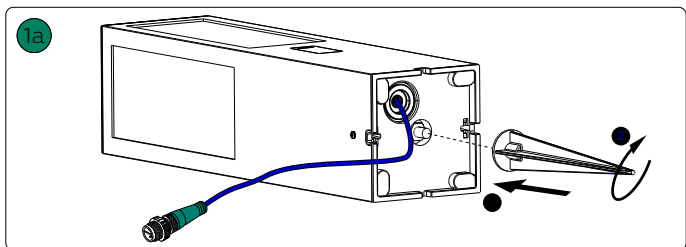
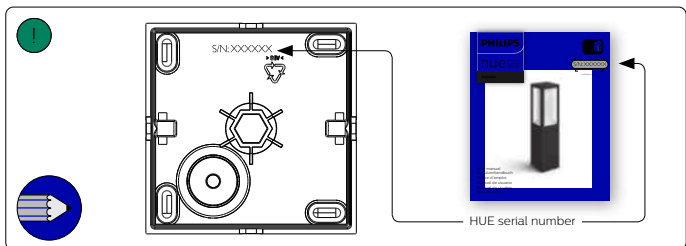
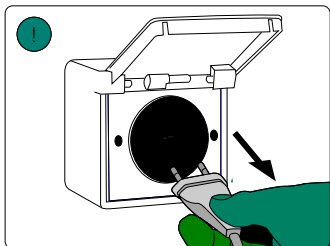
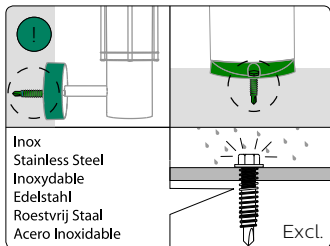

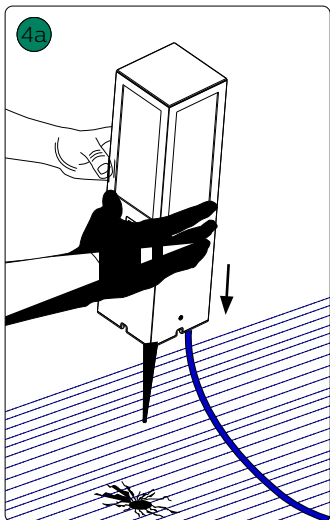
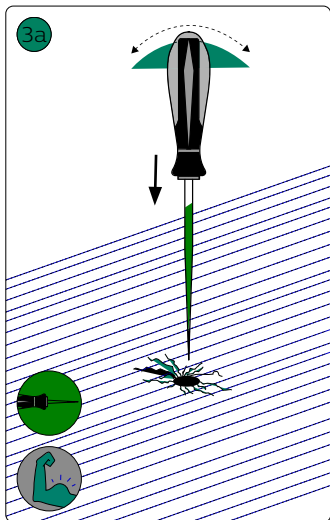
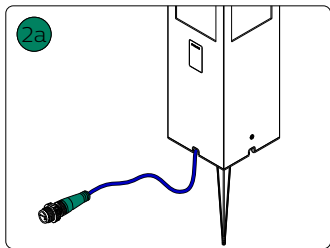

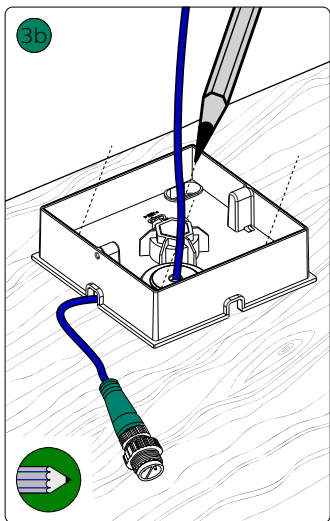
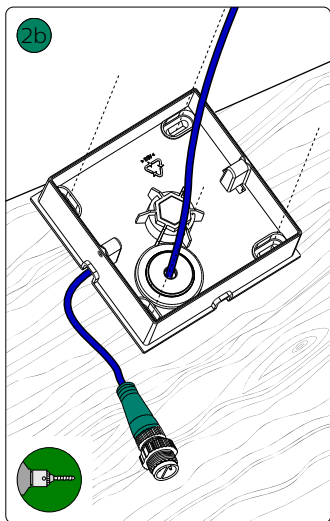
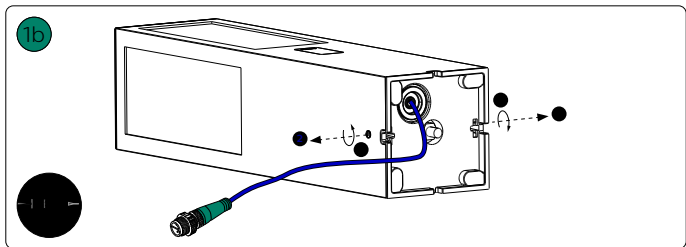

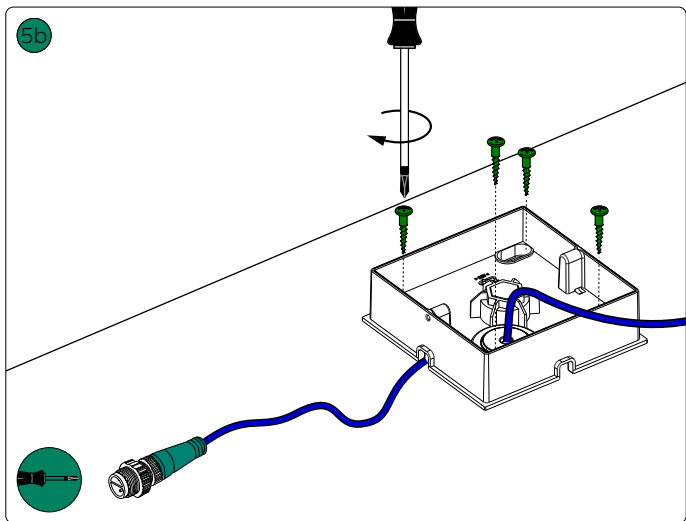
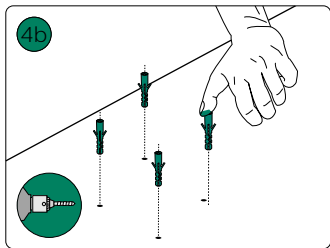

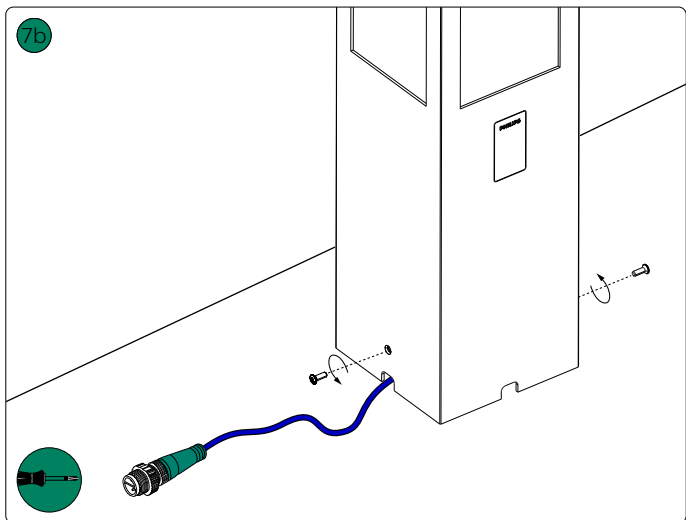
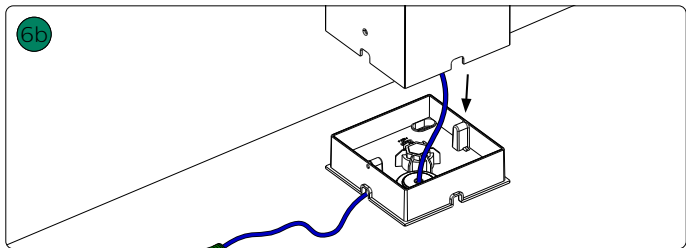

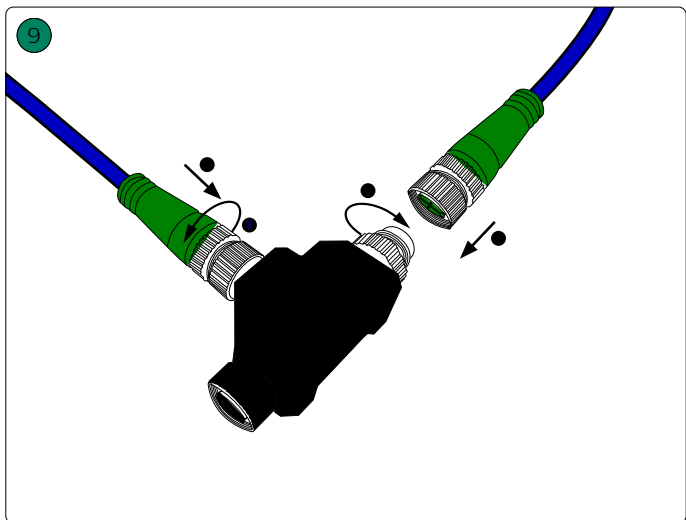
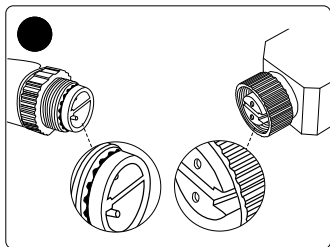

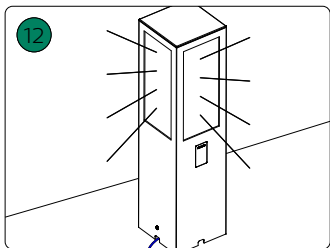
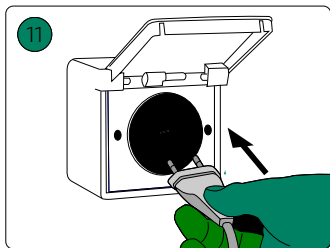
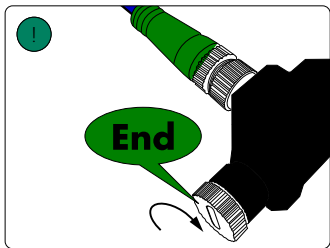
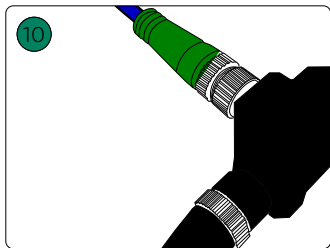

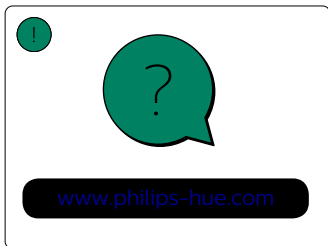
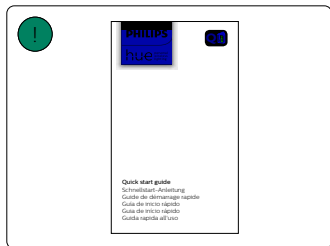



- EN** Use only with Philips Hue 24V luminaires!
- DE** Verwenden Sie nur mit Philips Hue 24V Leuchten!
- FR** Utiliser uniquement avec les luminaires Philips Hue 24V !
- ES** Utilizar solamente con Philips Hue 24V luminarias!
- PT** Utilize apenas com luminárias Philips Hue 24V!
- IT** Utilizzare solo con apparecchi Philips Hue 24V!

Philips Hue Low-volt system (24V)

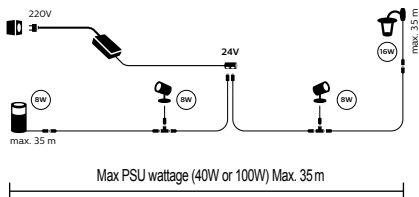



Signify
I.B.R.S. / C.C.R.I. Numéro 10461
5600 VB Eindhoven,
the Netherlands
☎00800-74454775

© 2021 Signify Holding
All rights reserved

www.philips-hue.com

17434/**/P7
4404 029 10922
Last update: 05/2021