

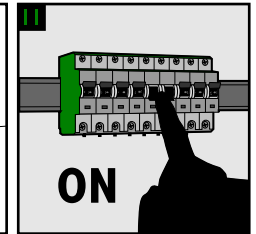

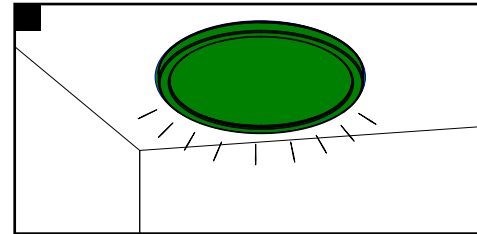

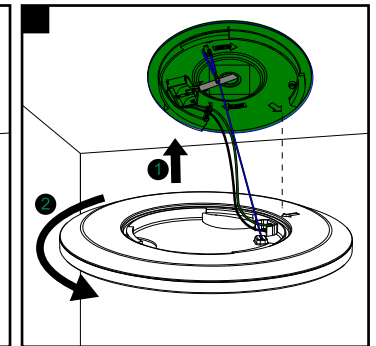

front

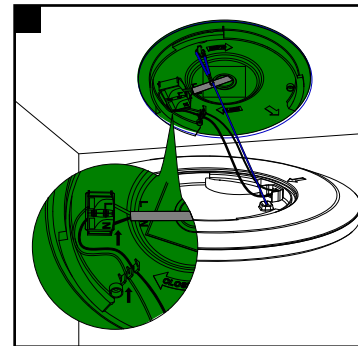
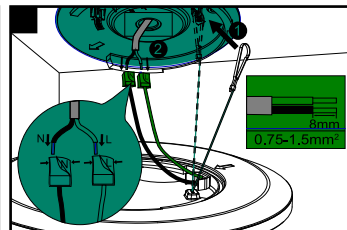
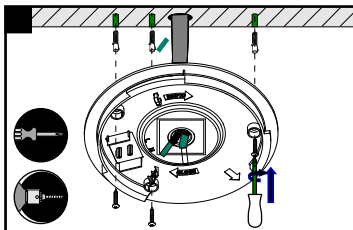
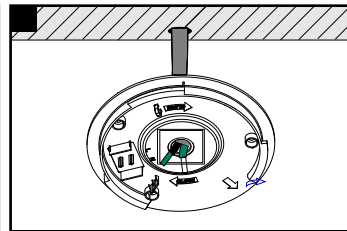
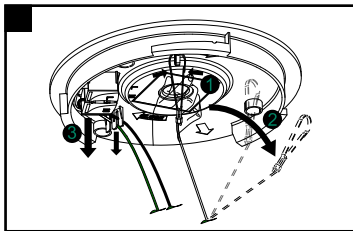
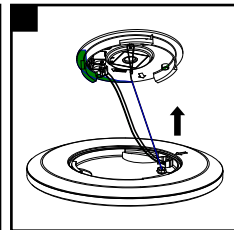
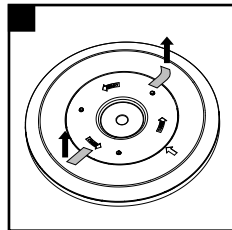
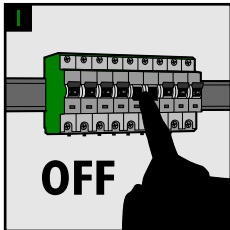
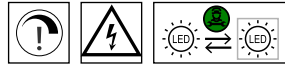
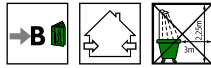

back

# PHILIPS

Superslim CL550



 100%   
 50%   
 10% 

 Memory feature remembers previous light setting  
**ON** → **OFF** → 

 9290025464 9290025466 9150057767 9150057768 9150057769  
 9150057779 9290026668 9290026669 9290026672 9290026673

Philips and the Philips shield emblem are registered trademarks of Koninklijke Philips N.V.  
 Signify  
 I.B.R.S. / C.C.R.I. Numéro 10461 Unit 3, Guildford Business Park,  
 5600 VB Eindhoven, the Netherlands Guildford, Surrey, GU2 8XG, UK  
[www.philips.com/lighting](http://www.philips.com/lighting)  
 © 2021 Signify Holding  
 @ignify



3241 653 91733  
 Last update: 28/04/21

size: 105mmx148mm