

2:5

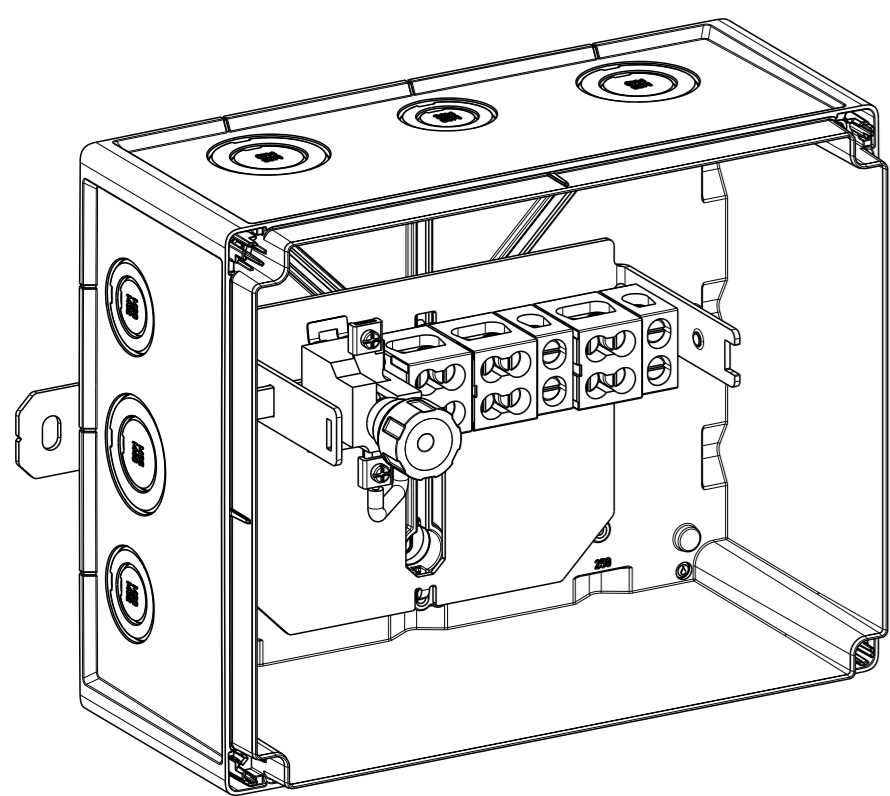
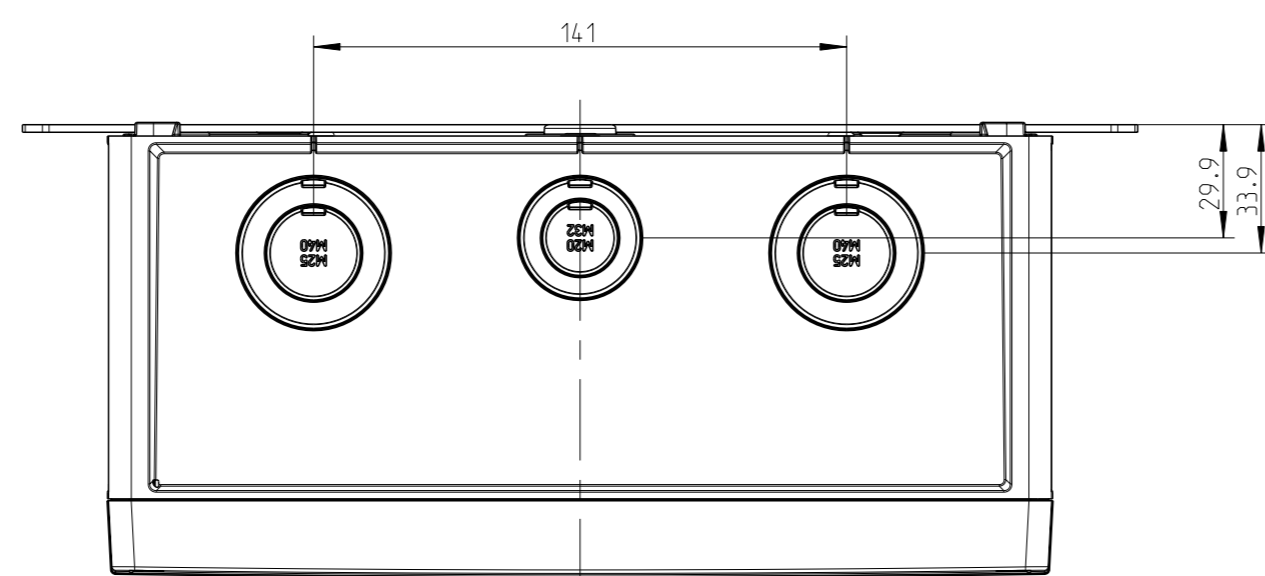
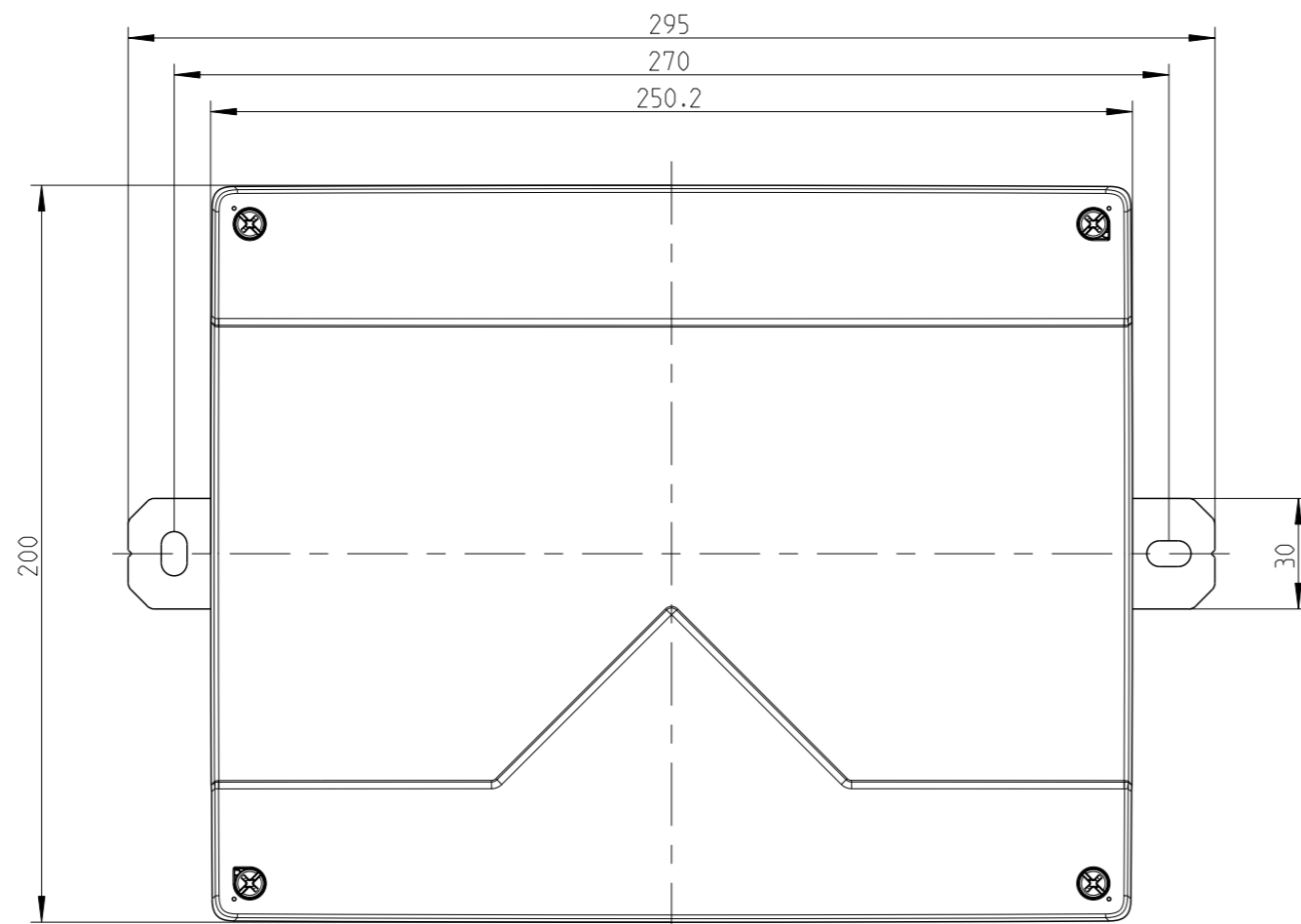
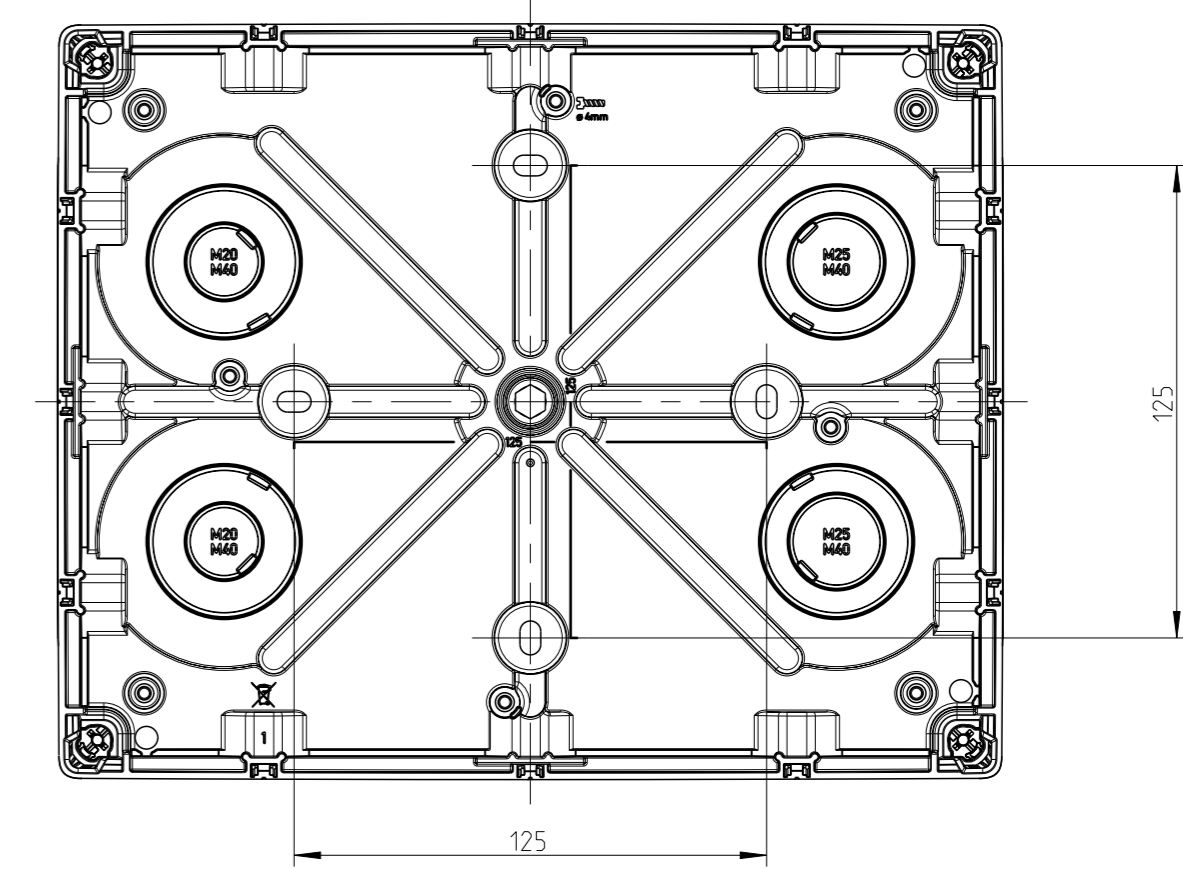
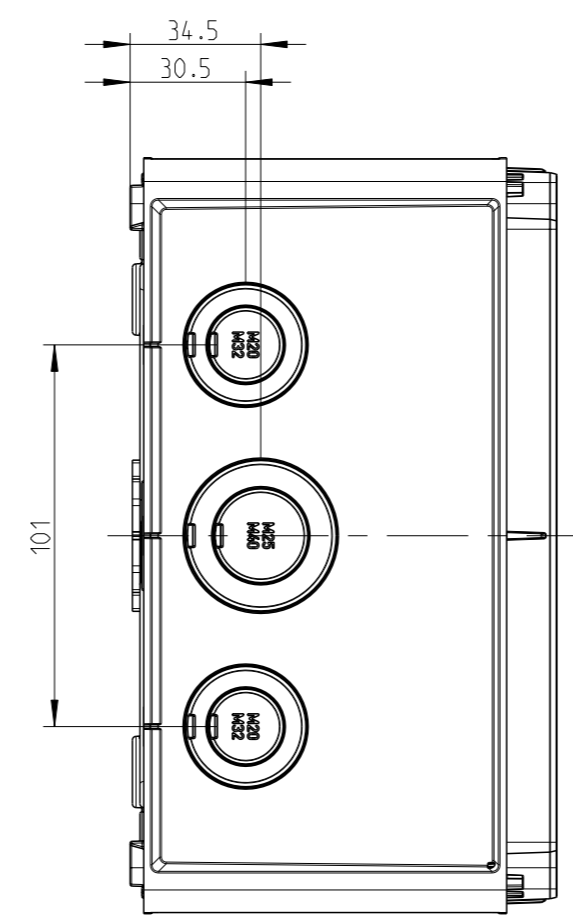
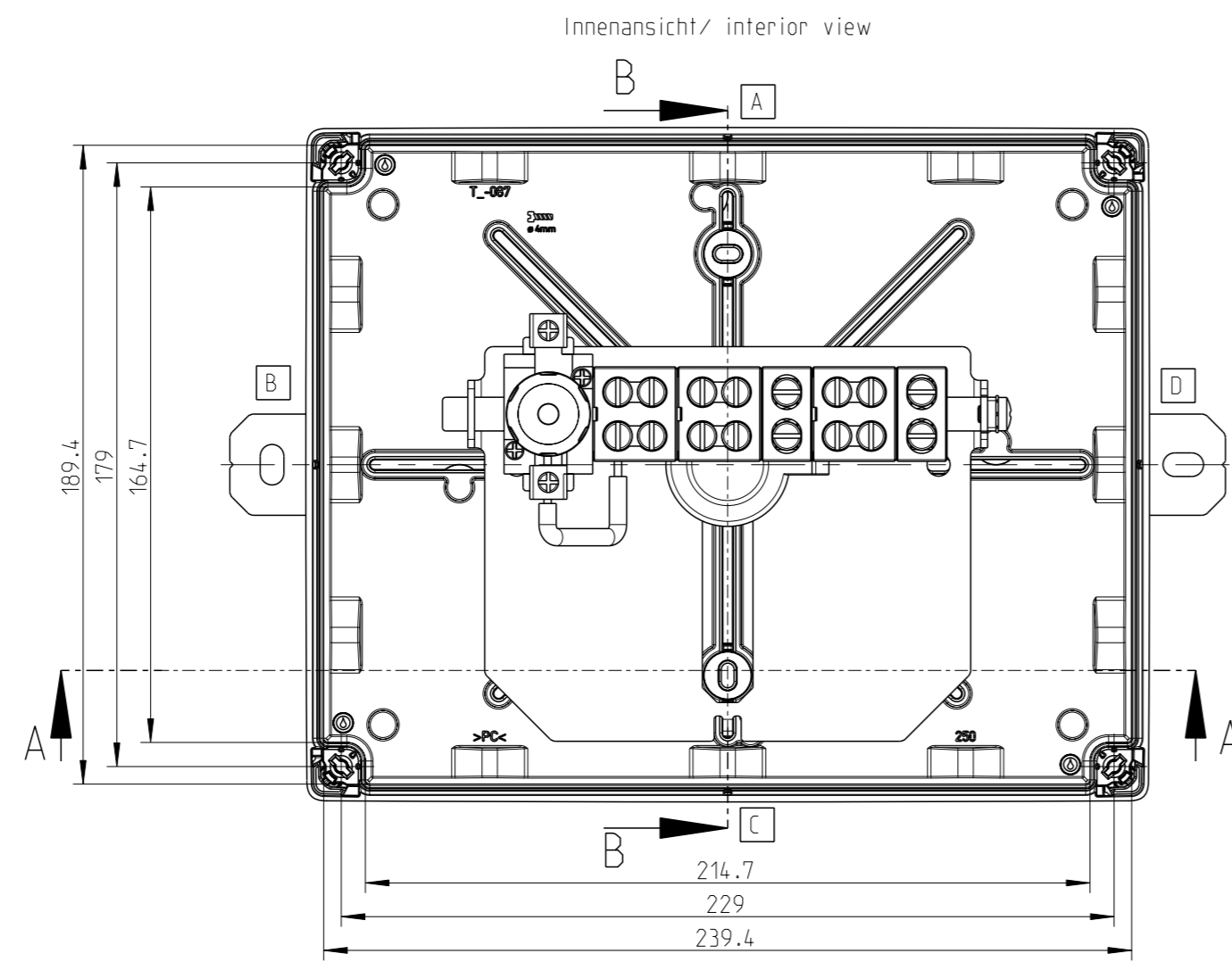
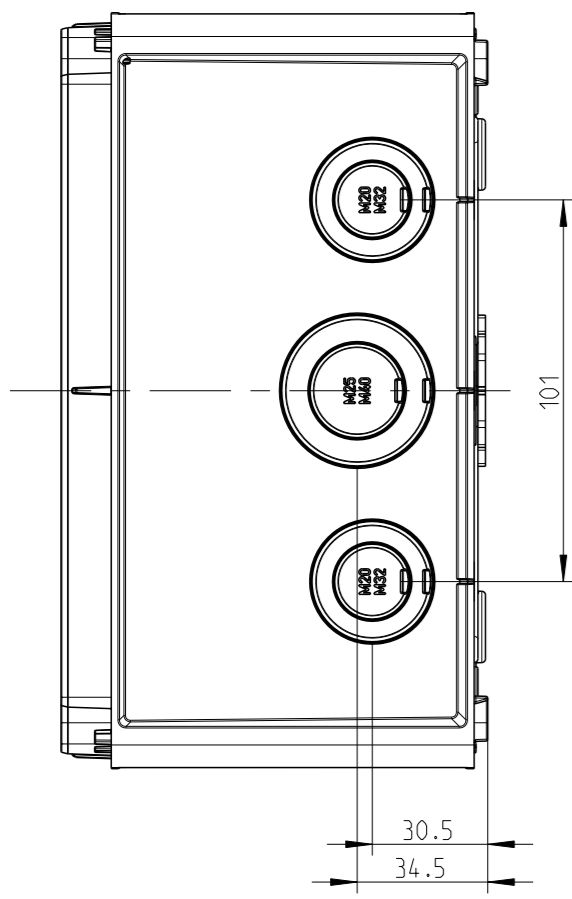
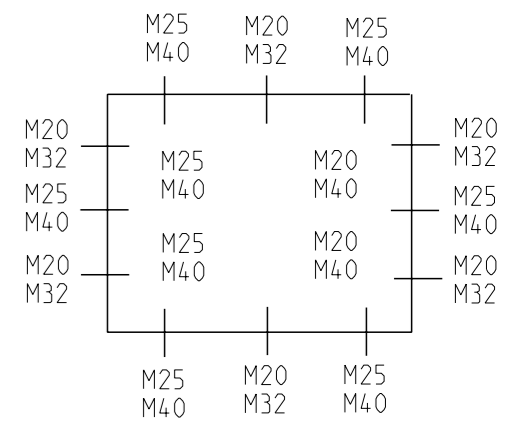
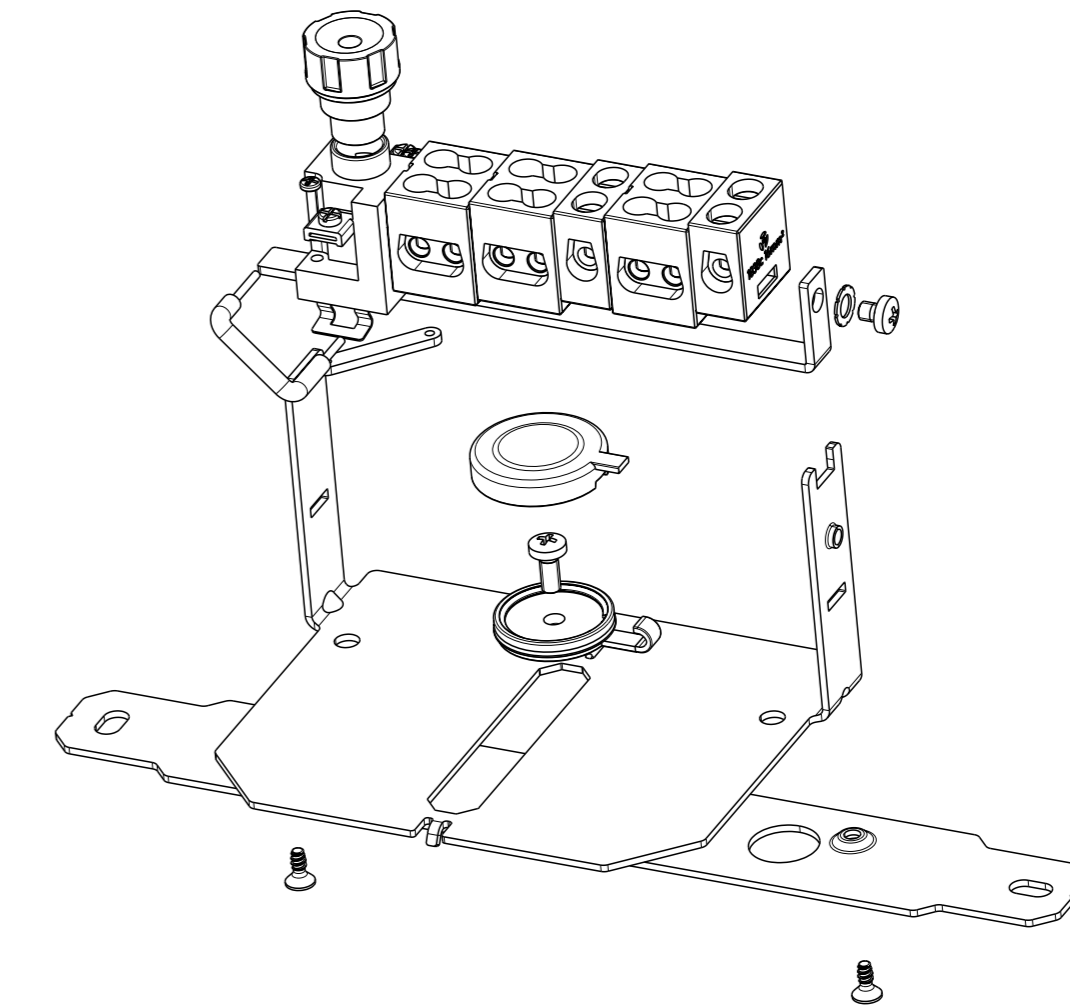
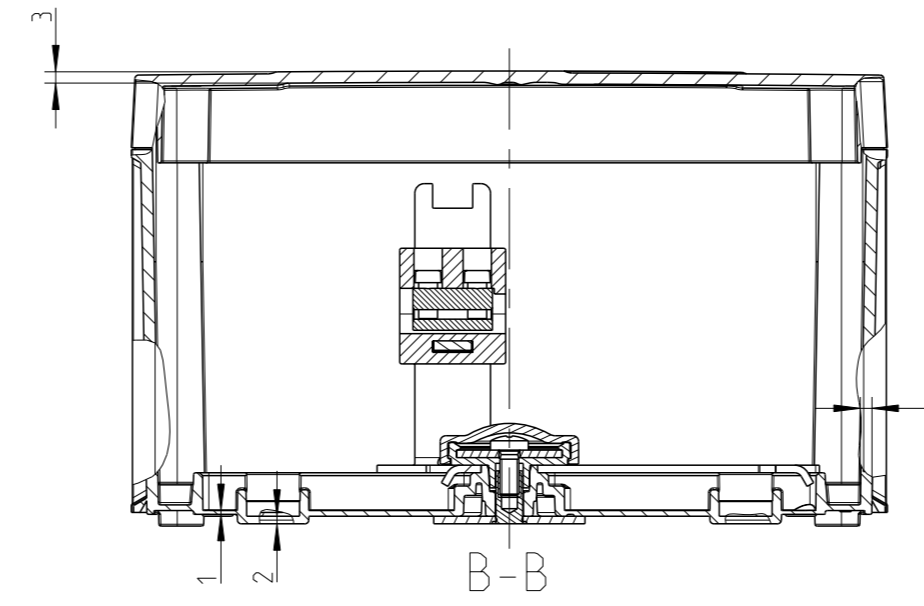
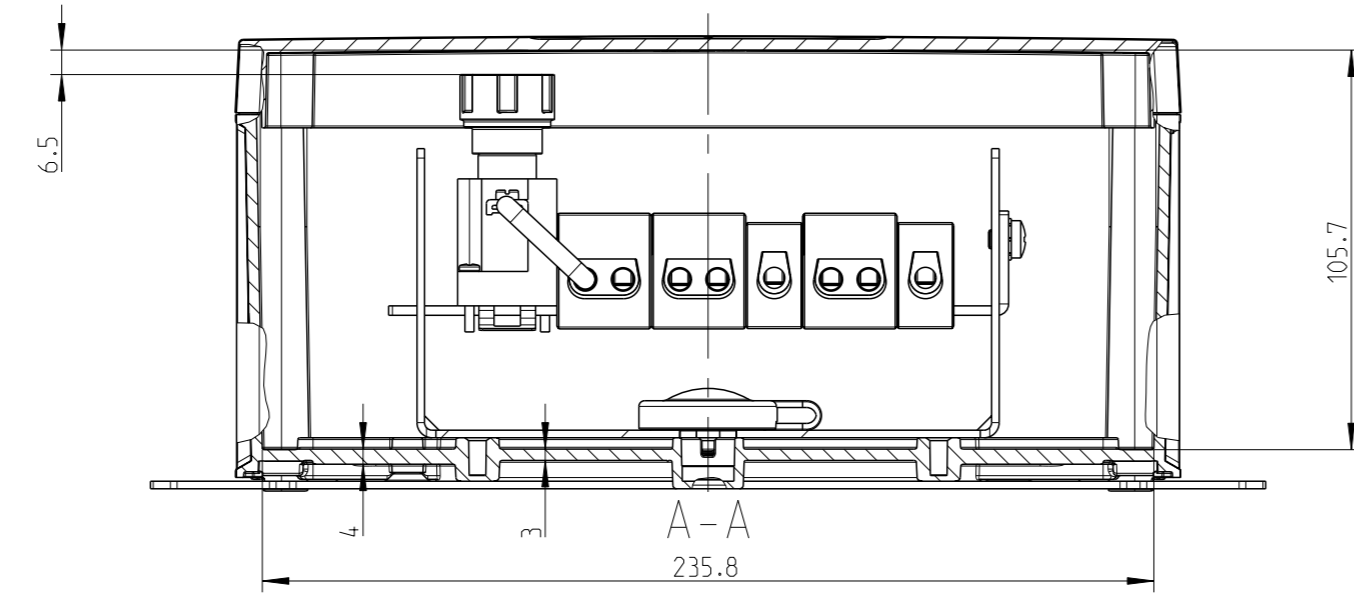
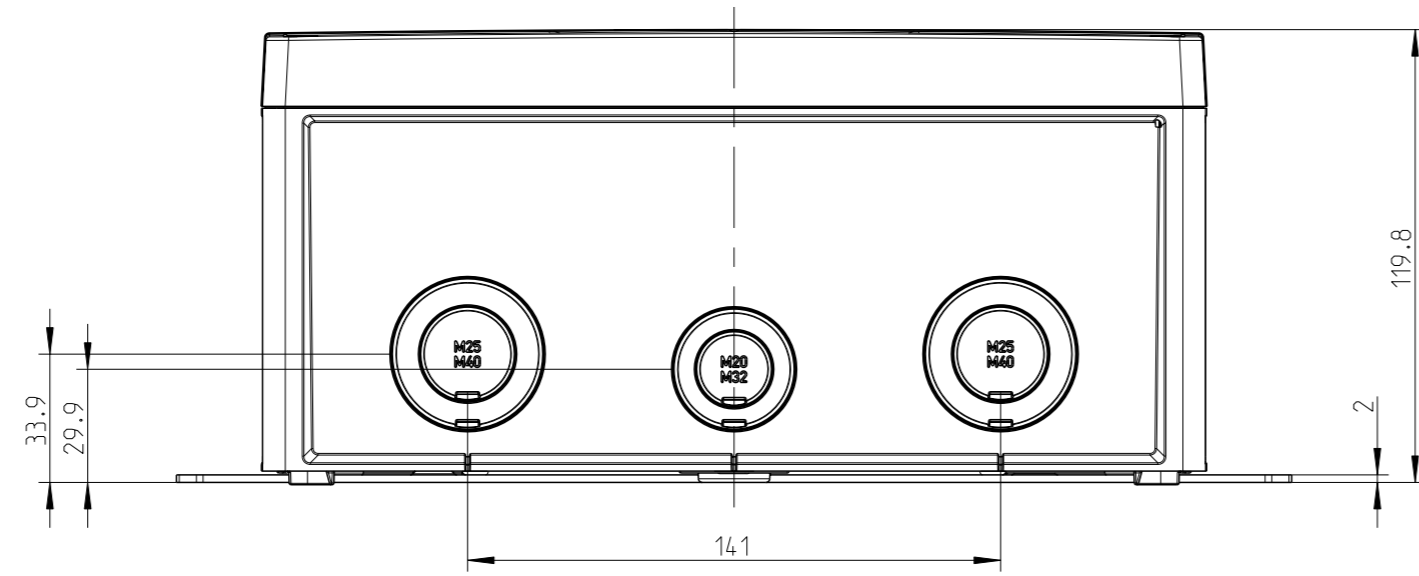

2:5

Fehlende Maße können dem DXF entnommen werden  
missing dimensions are provided in the DXF