

Niloé™ Step Cover plates

Cat. No(s): 8 630 91/92/93/94/95 - 8 631 91/92/93/94/95 - 8 632 91/92/93/94/95
 8 633 91/92/93/94/95 - 8 634 91/92/93/94/95 - 8 635 91/92/93/94/95
 8 636 91/92/93/94/95 - 8 637 91/92/93/94/95 - 8 638 91/92/93/94/95
 8 639 91/92/93/94/95

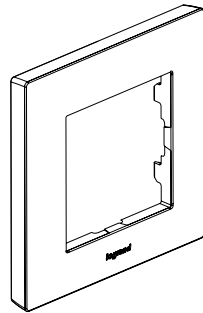

8 63X 91

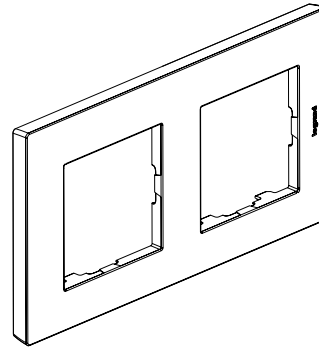

8 63X 92

1. USE

Faceplates for Niloé Step from 1 to 5 gangs wiring accessories.
 Available in several colours.

2. RANGE

1-gang plates

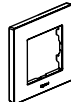
| | | |
|---|---------------------|----------|
|  | Atoll | 8 630 91 |
| | White | 8 631 91 |
| | Old pink | 8 632 91 |
| | Aluminium | 8 633 91 |
| | Medium grey | 8 634 91 |
| | Black | 8 635 91 |
| | Pearl | 8 636 91 |
| | Dark grey | 8 637 91 |
| | Brushed aluminium | 8 638 91 |
| | Brushed medium grey | 8 649 91 |

2-gang plates

71 mm spacing - horizontal and vertical

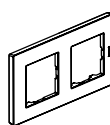
| | | |
|---|---------------------|----------|
|  | Atoll | 8 630 92 |
| | White | 8 631 92 |
| | Old pink | 8 632 92 |
| | Aluminium | 8 633 92 |
| | Medium grey | 8 634 92 |
| | Black | 8 635 92 |
| | Pearl | 8 636 92 |
| | Dark grey | 8 637 92 |
| | Brushed aluminium | 8 638 92 |
| | Brushed medium grey | 8 649 92 |

2. RANGE (continued)

3-gang plates

71 mm spacing - horizontal and vertical

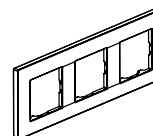
| | | |
|--|---------------------|----------|
|  | Atoll | 8 630 93 |
| | White | 8 631 93 |
| | Old pink | 8 632 93 |
| | Aluminium | 8 633 93 |
| | Medium grey | 8 634 93 |
| | Black | 8 635 93 |
| | Pearl | 8 636 93 |
| | Dark grey | 8 637 93 |
| | Brushed aluminium | 8 638 93 |
| | Brushed medium grey | 8 649 93 |

4-gang plates

71 mm spacing - horizontal and vertical

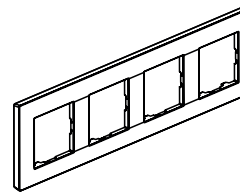
| | | |
|--|---------------------|----------|
|  | Atoll | 8 630 94 |
| | White | 8 631 94 |
| | Old pink | 8 632 94 |
| | Aluminium | 8 633 94 |
| | Medium grey | 8 634 94 |
| | Black | 8 635 94 |
| | Pearl | 8 636 94 |
| | Dark grey | 8 637 94 |
| | Brushed aluminium | 8 638 94 |
| | Brushed medium grey | 8 649 94 |

5-gang plates

71 mm spacing - horizontal and vertical

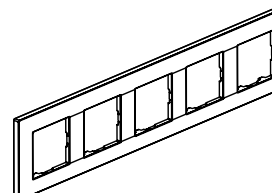
| | | |
|--|---------------------|----------|
|  | Atoll | 8 630 95 |
| | White | 8 631 95 |
| | Old pink | 8 632 95 |
| | Aluminium | 8 633 95 |
| | Medium grey | 8 634 95 |
| | Black | 8 635 95 |
| | Pearl | 8 636 95 |
| | Dark grey | 8 637 95 |
| | Brushed aluminium | 8 638 95 |
| | Brushed medium grey | 8 649 95 |

3. OVERALL DIMENSIONS (mm)

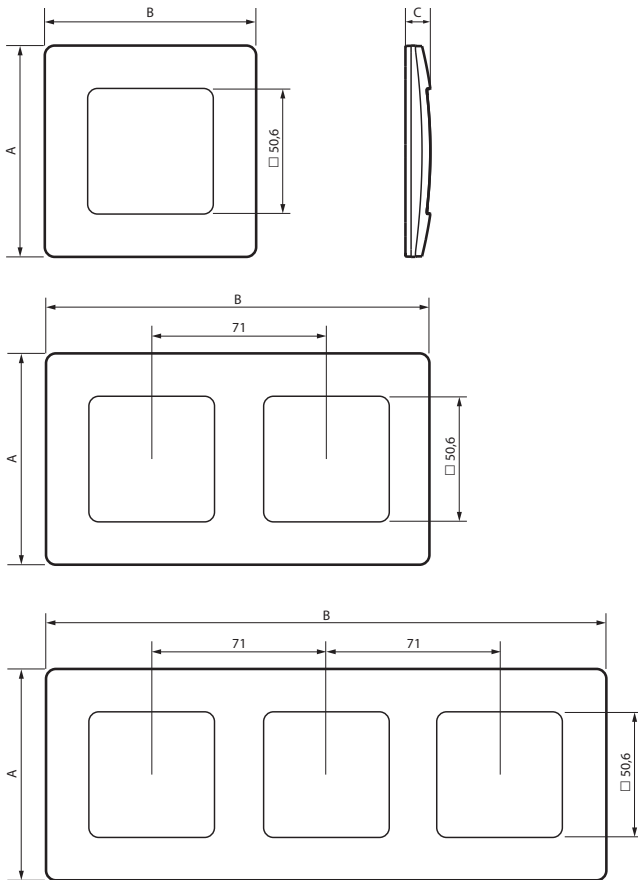

| | A | B | C |
|--------------------------------|----|-----|----|
| 1-gang | 86 | 86 | 10 |
| 2-gang 71 mm fixing centres | 86 | 157 | 10 |
| 3-gang 71 mm fixing centres | 86 | 228 | 10 |
| 4-gang 71 mm fixing centres | 86 | 299 | 10 |
| 5-gang 71 mm fixing centres | 86 | 370 | 10 |

4. TECHNICAL CHARACTERISTICS

■ **4.1 Materials**

Matt surface appearance

Material: - ABS plate

- Halogen-free

- UV resistant

Self-extinguishing:

+ 850°C/30 s for insulating parts holding live parts in place

+ 650°C/30 s for other parts made of insulating materials

■ **4.2 Climatic characteristics**

Storage and usage temperature: - 5°C to + 35°C

5. CLEANING

Clean the surface with a cloth.

Do not use acetone, tar-removing cleaning agents or trichloroethylene.

Caution: An initial test is required for the use of other special maintenance products.