

# NILOÉ<sup>STEP</sup>

8 631 72 / 73 / 74 / 75 / 76 / 78 / 79 / 80 / 82 / 83  
 8 633 72 / 73 / 74 / 75 / 76 / 78 / 79 / 80 / 82 / 83  
 8 634 72 / 73 / 74 / 75 / 76 / 78 / 79 / 80 / 82 / 83  
 8 635 72 / 73 / 74 / 75 / 76 / 78 / 79 / 80 / 82 / 83  
 8 640 50 / 51 / 52 / 53 / 54 / 55 / 56 / 57 / 58 / 59, 8 649 50 / 51 / 54 / 57

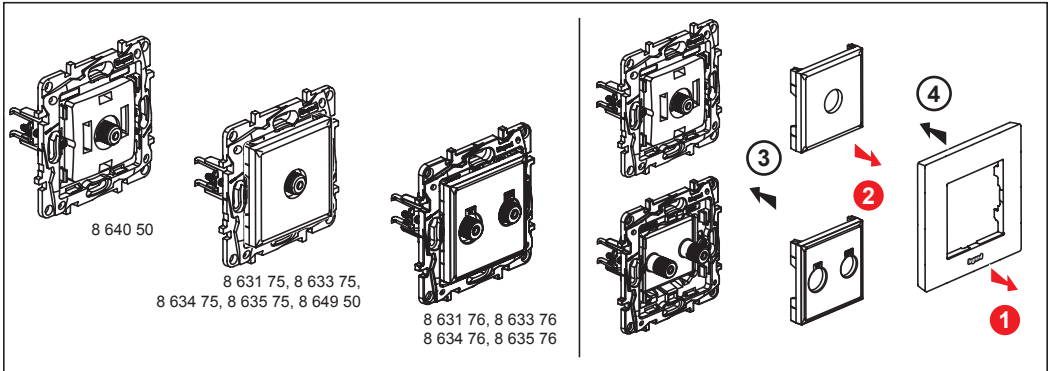

Z	Control	Return Path	Channel 1	Channel FM	Channel VHF	Channel UHF	Channel SAT (IF)	
75 Ω	500 mA	22 kHz 0,6 V	4 - 30 MHz	47 - 68 MHz	87,5 - 108 MHz	120 - 470 MHz	470 - 862 MHz	950 - 2400 MHz
8 631 75 / 76, 8 633 75 / 76 8 634 75 / 76, 8 635 75 / 76 8 640 50, 8 649 50		1,5 dB			1,5 dB		2 dB	

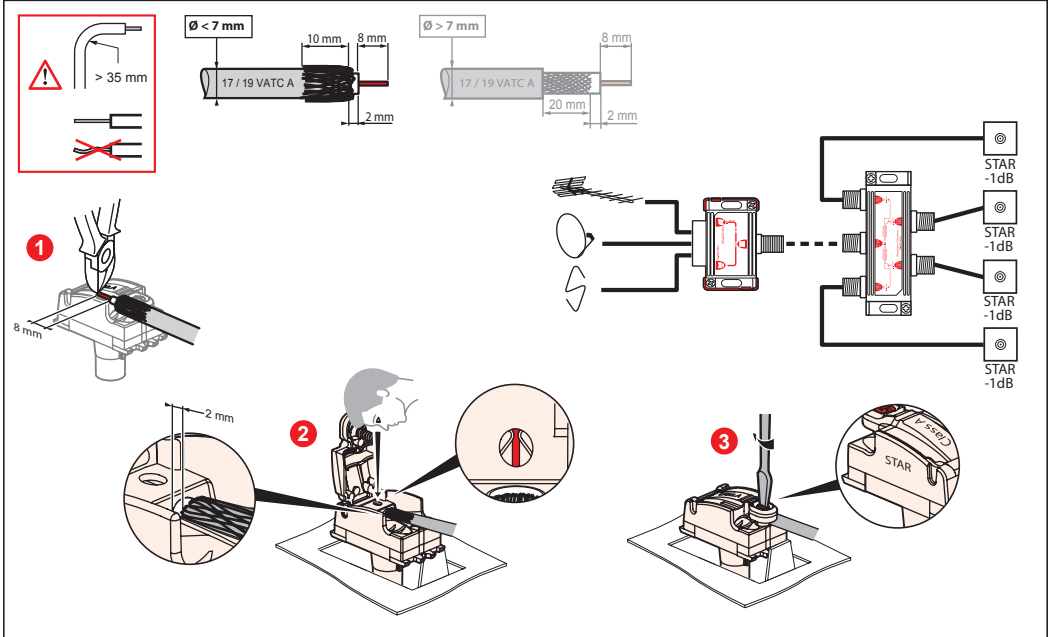

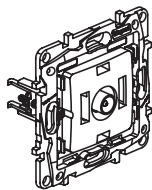

8 640 51 / 52 / 53

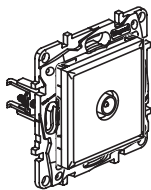

8 631 72 / 73 / 74, 8 633 72 / 73 / 74,  
8 634 72 / 73 / 74, 8 635 72 / 73 / 74,  
8 649 51

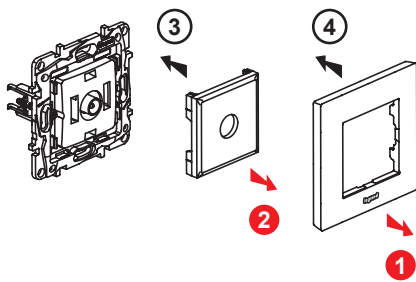

Control	Return Path	Channel 1	Channel FM	Channel VHF	Channel UHF	Channel SAT (IF)		
 Z	 —	22 kHz 0,6 V	4 - 30 MHz	47 - 68 MHz	87,5 - 108 MHz	120 - 470 MHz	470 - 862 MHz	950 - 2400 MHz
8 631 74, 8 633 74, 8 634 74 8 635 74, 8 640 51, 8 649 51	1,5 dB	1,5 dB					2 dB	
8 631 72, 8 633 72, 8 634 72 8 635 72, 8 640 52		14 dB						
8 631 73, 8 633 73, 8 634 73 8 635 73, 8 640 53		10 dB						

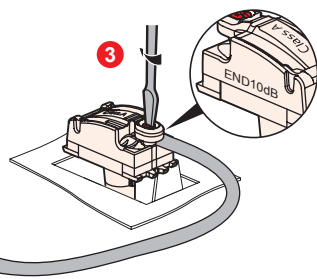
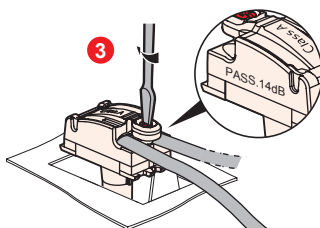
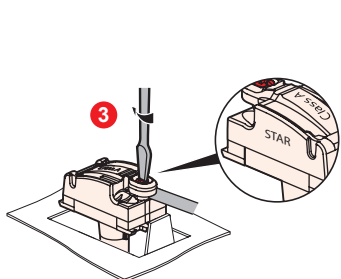
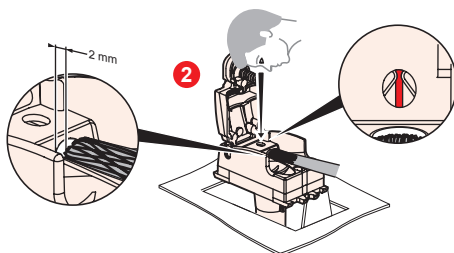
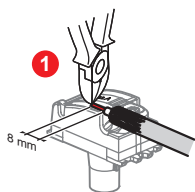
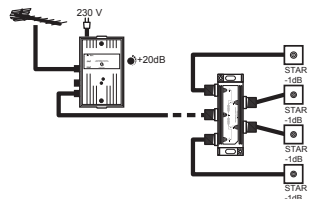
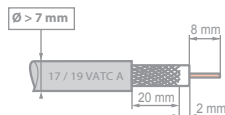
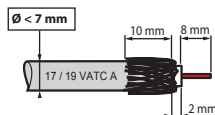
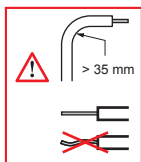

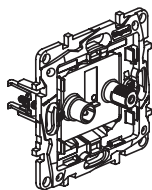

8 640 54 / 55 / 56

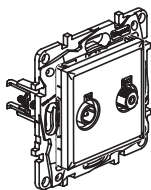

8 631 83, 8 633 83  
8 634 83, 8 635 83, 8 649 54

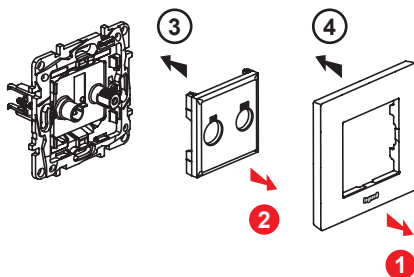

Z	Control	Return Path	Channel 1	Channel FM	Channel VHF	Channel UHF	Channel SAT (IF)	
75 Ω	500 mA	22 kHz 0,6 V	4 - 30 MHz	47 - 68 MHz	87,5 - 108 MHz	120 - 470 MHz	470 - 862 MHz	950 - 2400 MHz
8 631 83, 8 633 83, 8 634 83 8 635 83, 8 640 54, 8 649 54	1,5 dB	1,5 dB						2 dB
8 640 55		14 dB						
8 640 56		10 dB						

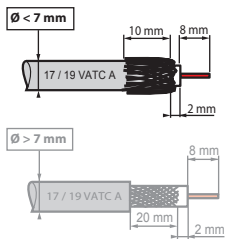
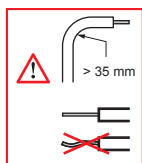

TV-SAT	Model	Diagram
	8 640 54 8 649 54	
	8 640 55	
	8 640 56	
	8 631 83 8 633 83 8 634 83 8 635 83	

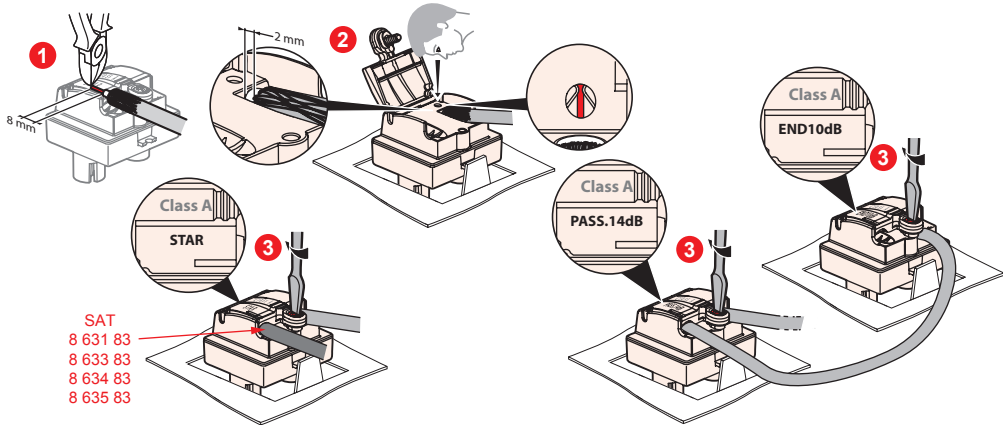

SAT  
8 631 83  
8 633 83  
8 634 83  
8 635 83

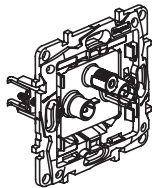

8 640 57 / 58 / 59

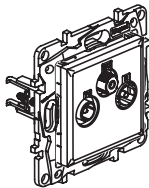

8 631 78 / 79 / 80  
8 633 78 / 79 / 80  
8 634 78 / 79 / 80  
8 635 78 / 79 / 80  
8 649 57

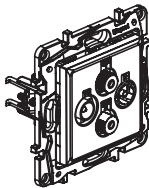

8 631 82, 8 633 82  
8 634 82, 8 635 82

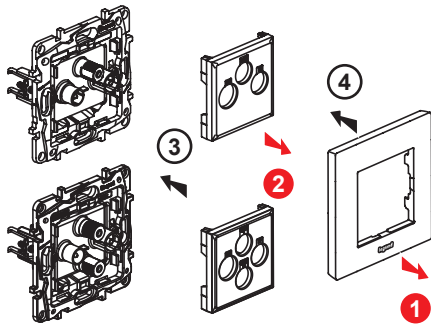

		Control	Return Path	Channel 1	Channel FM	Channel VHF	Channel UHF	Channel SAT (IF)
75 Ω	500 mA	22 kHz 0,6 V	4 - 30 MHz	47 - 68 MHz	87,5 - 108 MHz	120 - 470 MHz	470 - 862 MHz	950 - 2400 MHz
8 631 80 / 82, 8 633 80 / 82 8 634 80 / 82, 8 635 80 / 82 8 640 57, 8 649 57		1,5 dB	1,5 dB					2 dB
8 631 78, 8 633 78, 8 634 78 8 635 78, 8 640 58			14 dB					
8 631 79, 8 633 79, 8 634 79 8 635 79, 8 640 59			10 dB					

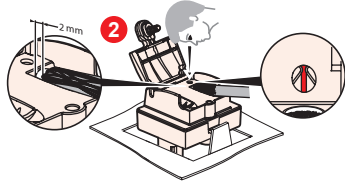
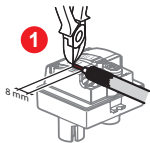
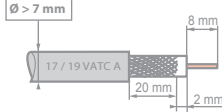
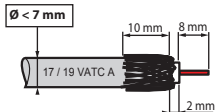
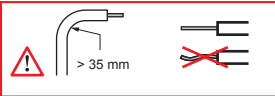

TV-R-SAT	8 640 57 8 649 57			
	8 640 58			
	8 640 59			
TV-R-SAT-SAT	8 631 82 8 633 82 8 634 82 8 635 82			

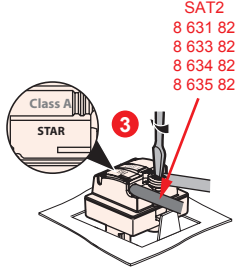
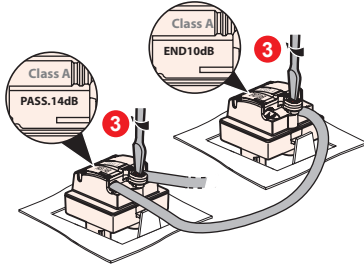

SAT2  
8 631 82  
8 633 82  
8 634 82  
8 635 82