

Hliníkový profil SX pro sklo 8mm, bez difuzoru, 2m

Kód produktu: **ML-761.122.02.2**Typ produktu: **SX - profile, 2m**

McLED Asist

+420 220 184 886, +420 220 184 827, +420 220 184 894, +420 220 184 881

support@mcled.cz

Popis: Hliníkový profil pro LED pásy, rozměry průřezu cca 11x12mm. Součástí není difuzor. Tento profil je určen pro krytí a chlazení LED pásek do šíře 10mm. Vhodný pro montáž na 8mm sklo nebo plexisklo. K profilu lze zakoupit adhesivní páska pro spojení hliník-sklo. Pro pásy max. 9,6W/m.

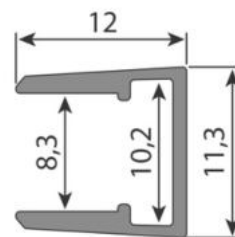

Parametry:

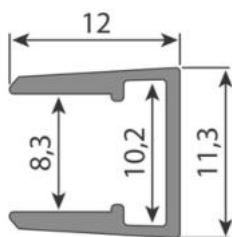
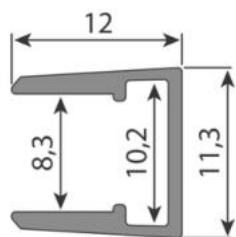
Typ příslušenství: [Profil](#)Typ profilu: [Pro sklo](#)Pro pásek šíře do [mm]: **10**Pro výkon pásku do [W/m]: **9,6**Prodej na míru: [Ano](#)Materiál: [Hliník](#)Hmotnost [kg]: **0,1**Šířka [mm]: **11,3**Výška [mm]: **12**Barva: [Hliník](#)Povrchová ochrana: [Eloxování](#)Min. délka profilu [mm]: **25**Délka segmentů [mm]: **1**Záruka McLED [M]: **24**EAN: **8595607113878**

max. 10 mm



max. 10 mm

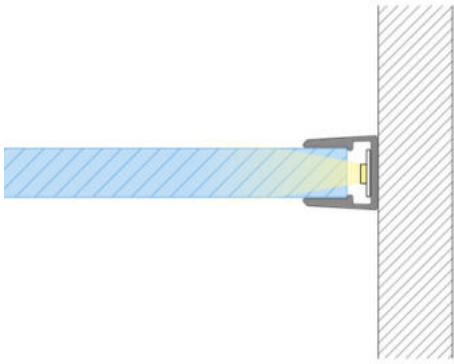

ML-762.213.07.0



ML-762.213.07.0

