

	100 - 240 V~
	50 / 60 Hz
	2 x 2,5 mm <sup>2</sup>
	-5°C / +45°C
	PIR
	500 lux
	15 mn
	Ø 8 m

230 V~	2000 W	8,5 A	1000 VA	4,3 A	10 x (2x36W)	4,3 A	500 VA	2,1 A	1000 VA	4,3 A	500 VA	2,1 A	I max. ≤ 2A
110 V~	1000 W		500 VA		5 x (2x36W)		250 VA		500 VA		250 VA		

230 V~	500 VA	2 A	I max. ≤ 2A
110 V~	250 VA		
U ≤ 30 V=	2 A maxi		

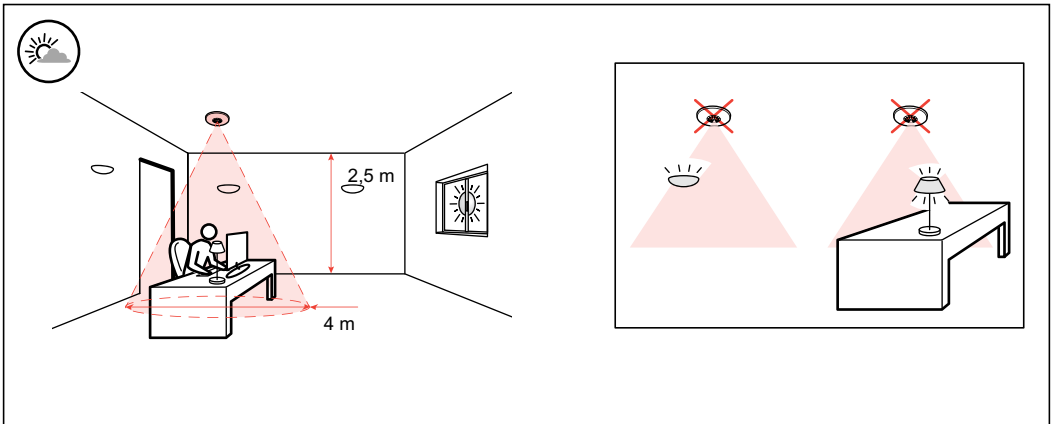

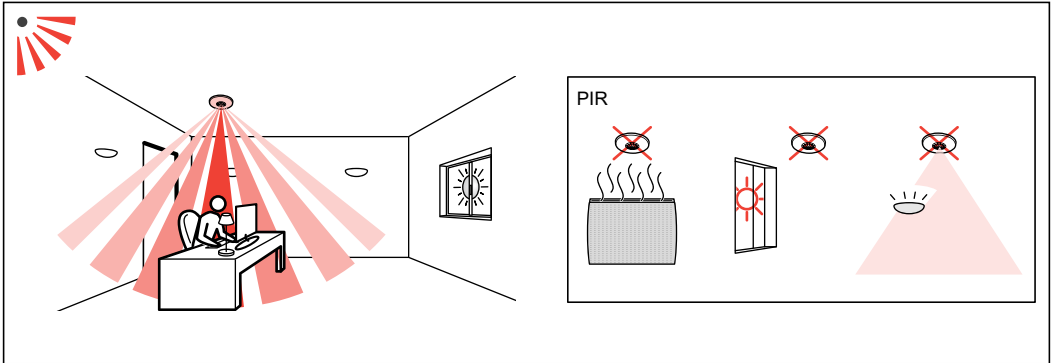
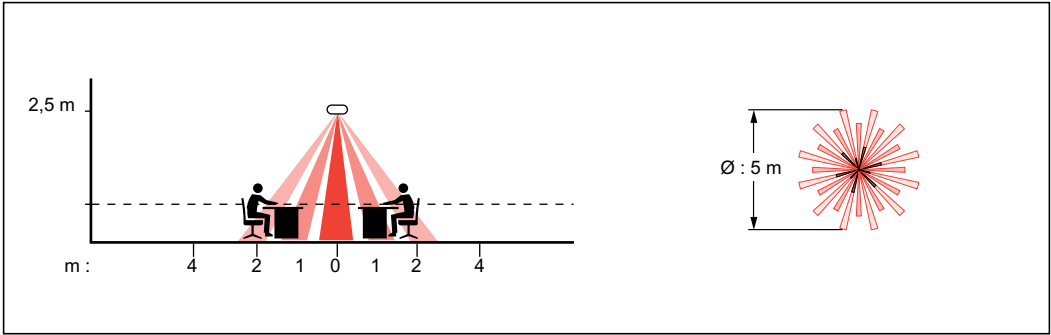
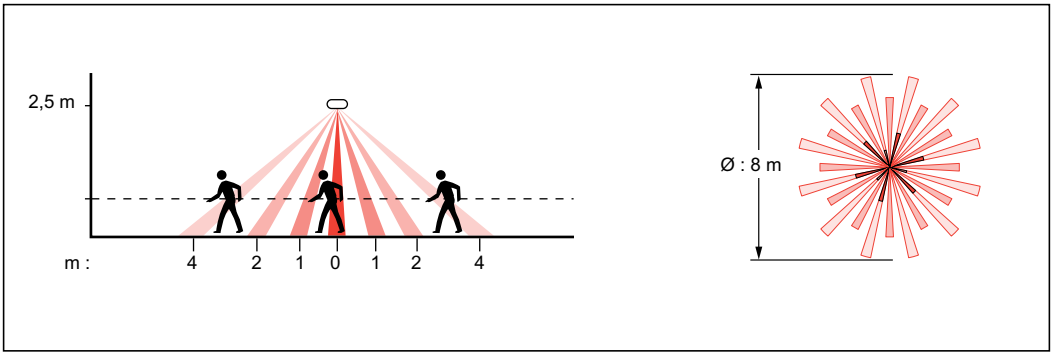

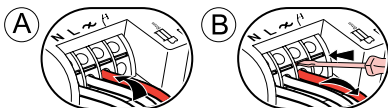
230  
110 VAC



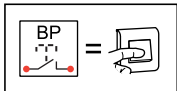
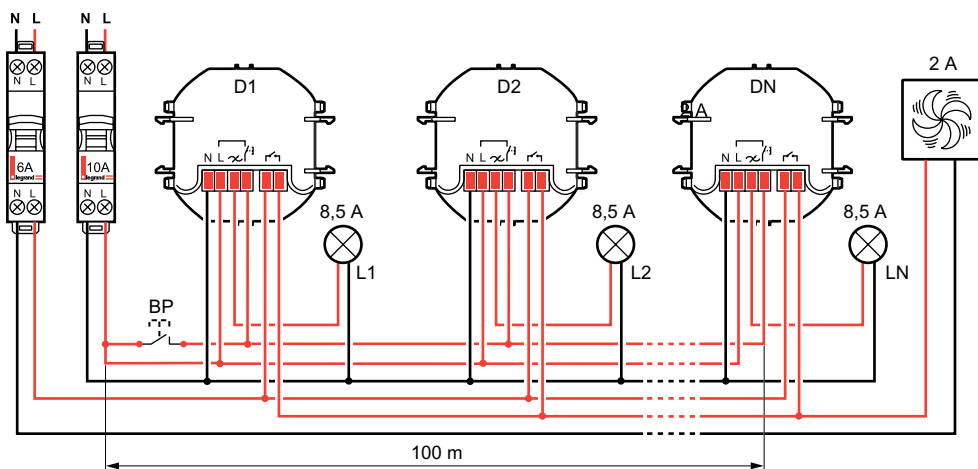
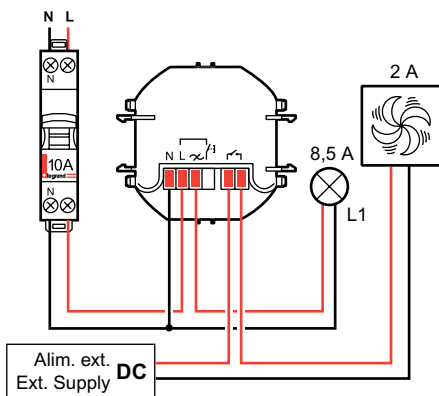
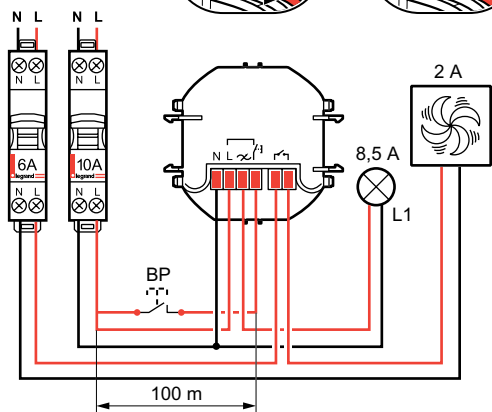

$U \leq 30V =$





- Inversion de l'état des charges :  < 1 s
- Reversal of load status :

- Synchronisation de toutes les charges à ON :
- Switching all loads to ON :  > 1 s

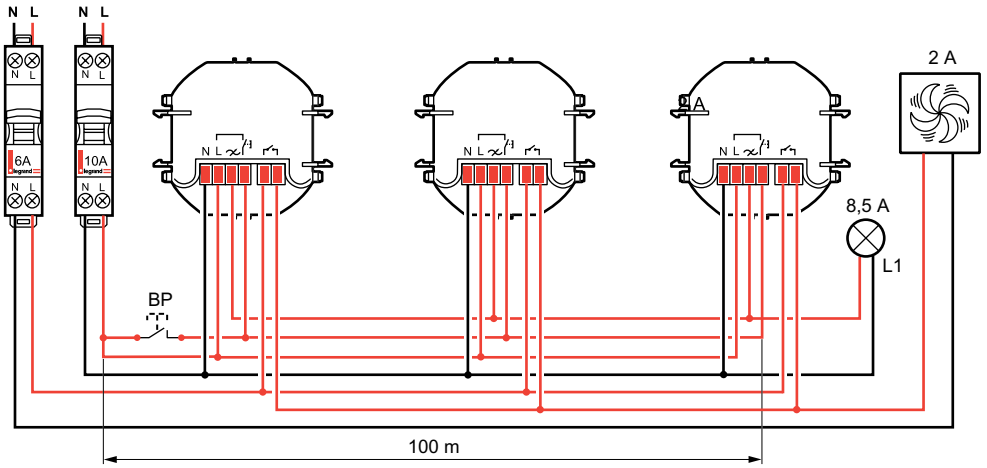
- Synchronisation de toutes les charges à OFF :
- Switching all loads to OFF :  > 1 s +  < 1 s



- Etat des charges ON :  > 1 s
- Load status ON :
- Etat des charges OFF :  > 1 s +  < 1 s
- Load status OFF :

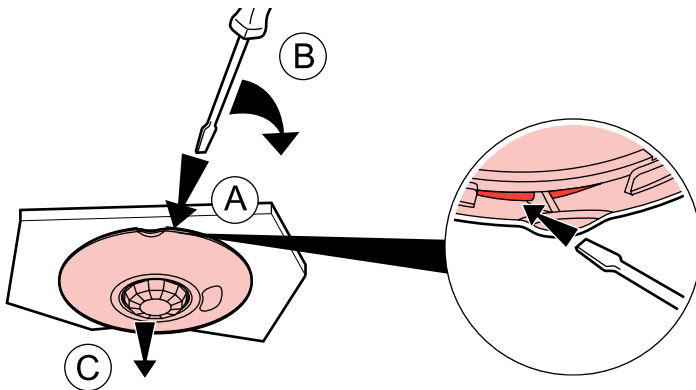
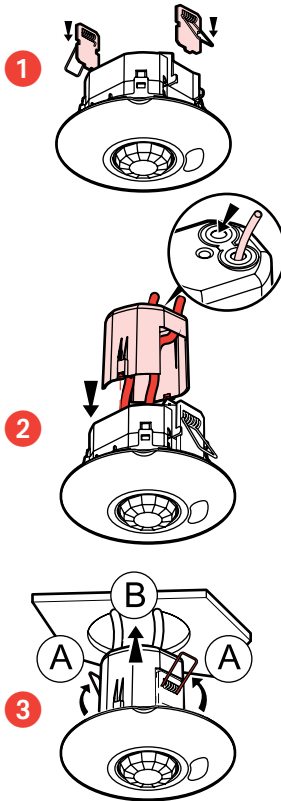
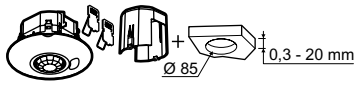



**Auto ON/OFF**

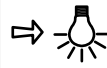
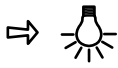

**Manual ON / Auto OFF**

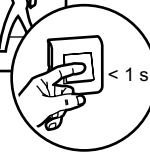
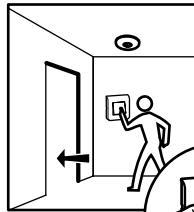
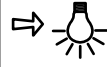
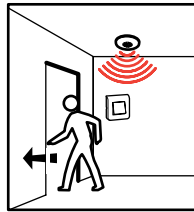
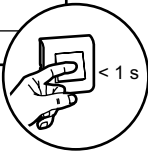
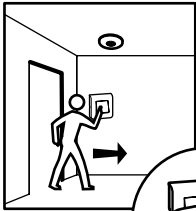

[www.legrandoc.com](http://www.legrandoc.com)

	5 - 1275 lux
	5 sec - 59 min 59 sec
	25% - 50% - 75% - 100%
Mode	Auto - Manual - Walkthrough



0 882 30



0 882 35

