





H4704C

1. USE

Supporting frames for mounting Livinglight air mechanisms.
The supporting frames are supplied with a pre-installed orange frame cover and a transparent protection.

2. RANGE

Supports for flush-mounting	Frame modules	Cat. Nos
	2	LN4702C
	3	LN4703C
	4	LN4704C
	7	LN4706C
	3 + 3	LN4726C

3. OVERALL DIMENSIONS (mm)

■ Support frame 2 modules

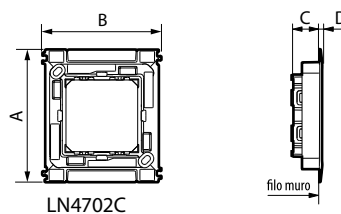

■ Support frame 3 modules

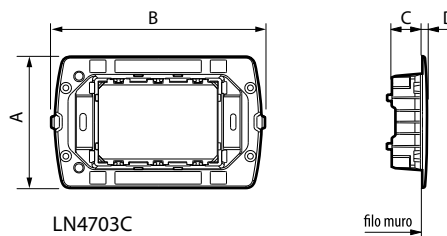

■ Support frame 4 modules

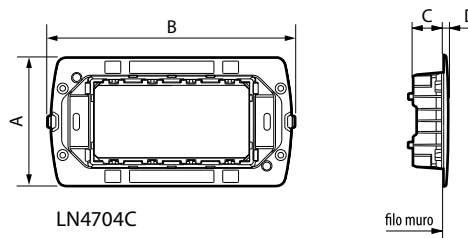

■ Support frame 7 modules

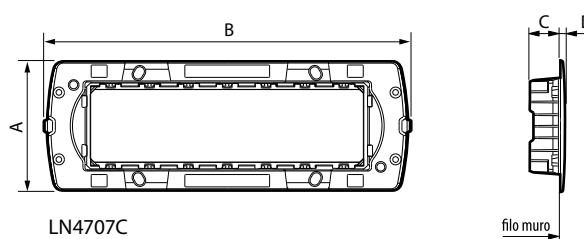

Supporting frames for Air range

3. OVERALL DIMENSIONS (mm) (continued)

■ Support frame 3 + 3 modules

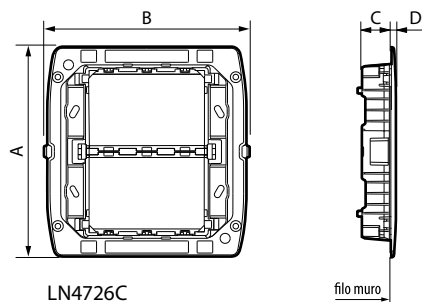

Cat. Nos	A	B	C	D
LN4702C	82	74	17	1.8
LN4703C	73	119	20	2.5
LN4704C	73	141	20	2.5
LN4707C	73	207	17	2.5
LN4726C	121	119	20	2.5

4. MOUNTING

The supporting frames are screwed to flush mounting boxes.

5. TECHNICAL CHARACTERISTICS

■ 5.1 Material characteristics

Supports are in stainless steel and polycarbonate glass fiber filled.

■ 5.2 Electrical characteristics

Self-extinguishing: 650° C / 30 s

■ 5.3 Climatic characteristics

Storage temperature: - 10° C to + 70° C

Use temperature: - 5° C to + 50° C