

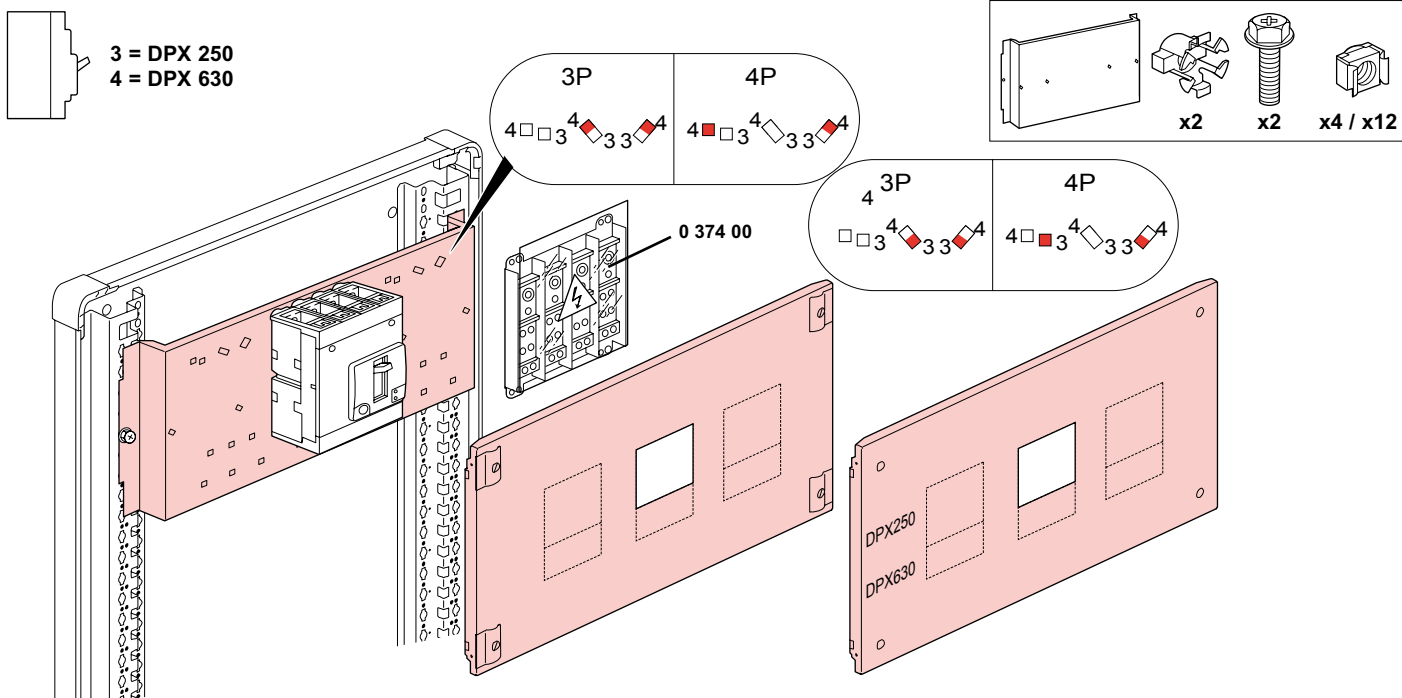

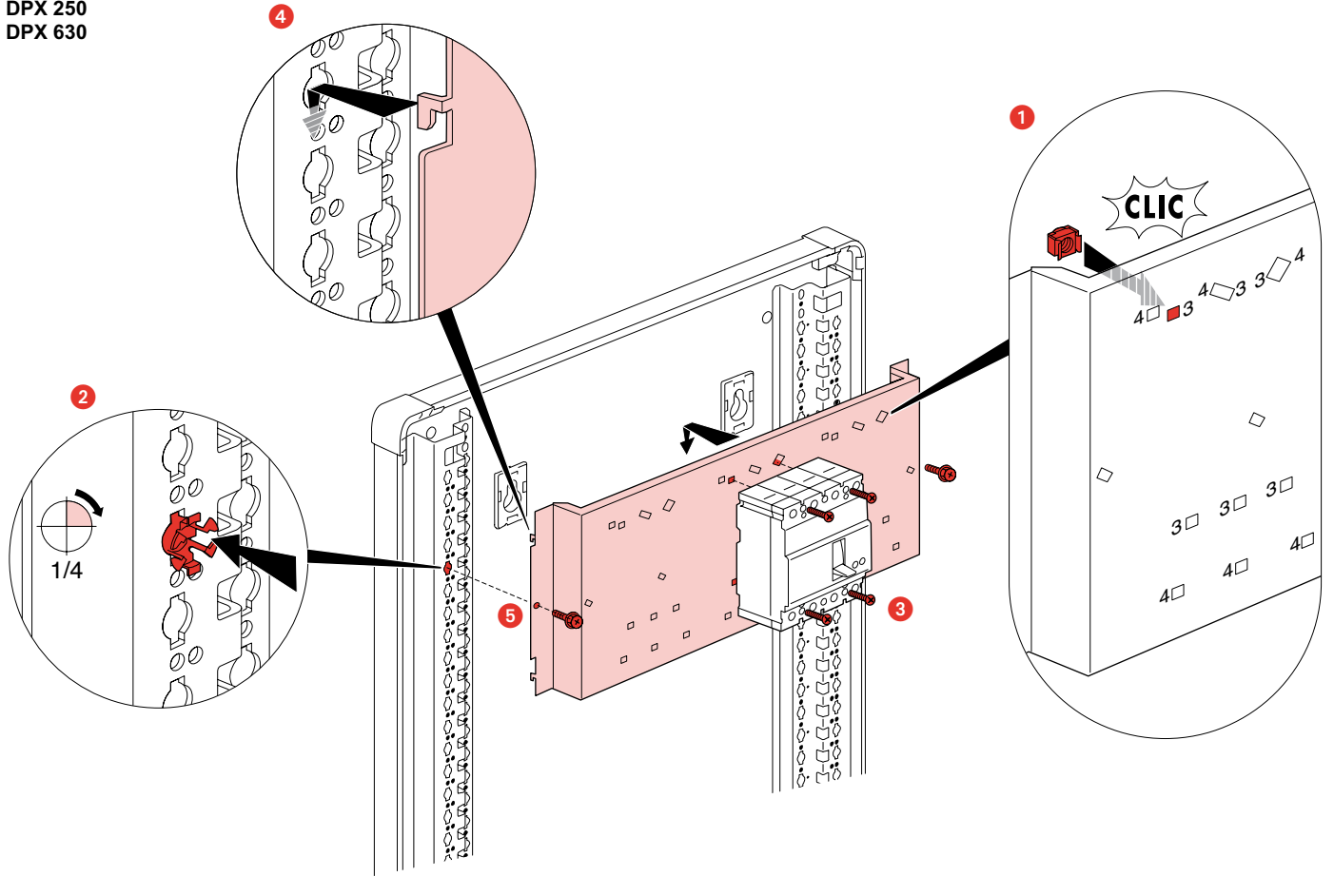



L = 660	0 206 11		0 208 10	0 209 10	300 mm
	0 206 08		0 208 05	0 209 05	300 mm
	0 206 11 (+ 0 4210 58)		0 208 10	0 209 10	300 mm
	0 206 13		0 208 10	0 209 10	300 mm
L = 910	0 206 61			0 209 60	300 mm
	0 206 11 (+ 0 4210 58)			0 209 60	300 mm

DPX 250
DPX 630

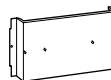

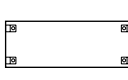
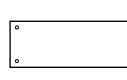
						
L = 250	0 206 78	DPX 250 / 630	x 1	0 204 48 0 204 49	— —	1400 mm 1800 mm
L = 460	0 206 28	DPX 250 / 630	x 1	— —	0 204 43 0 204 44	1400 mm 1800 mm
L = 660	0 206 20	DPX 250	x 3	0 208 20	0 209 20	400 mm
		DPX 630	3P • 3P • 3P 4P • / • 4P 4P • 3P • 3P			
L = 910	0 206 70	DPX 250 / 630	x 3	—	0 209 70	400 mm

3 = DPX 250
4 = DPX 630

3P 4P

3P 4P

x2 x2 x4 / x12

DPX250
DPX630
DPX630
DPX250
DPX630

L	DPX	DPX	DPX	DPX	DPX
L = 250	0 206 79	DPX 250 / 630	x 1	0 204 48 0 204 49	- -
L = 460	0 206 29	DPX 250 / 630	x 1	- -	0 204 43 0 204 44
L = 660	0 206 22	DPX 250	x 3	0 208 22	0 209 22
		DPX 630	3P • 3P • 3P 4P • / • 4P 4P • 3P • 3P		
L = 910	0 206 72	DPX 250 / 630	x 3	-	0 209 72

DPX 1600

3P 4P

x2 x2 x6

L	DPX	DPX	DPX	DPX	DPX
L = 660	0 211 00	DPX 1600	x 1	0 211 10	0 211 11
L = 910		DPX IS 1600		-	0 211 13
	0 211 02	DPX 1600		-	0 211 12