

**Pro 21/Galea/Sistena socket for LCS<sup>6</sup>  
 Category 6**

Cat. No(s) : 7757 98/99  
 7758 23/28/30/40/41/47

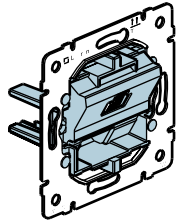

UTP/FTP

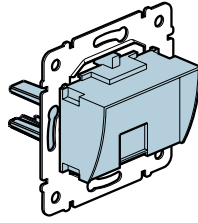

STP

CONTENTS	PAGE
1. General characteristics .....	1
2. Presentation .....	1
3. Mounting .....	1
4. Technical characteristics .....	1
5. Installation instructions .....	1
6. Dimensions .....	2
7. Standard connection .....	2
8. Performance	
1 - components .....	2/3
2 - permanent link .....	3/4
3 - channel .....	5/6
9. Standards and approvals .....	6

**1. GENERAL CHARACTERISTICS**

Category 6 RJ 45 socket.  
 For high speed transmission (Gigabit Ethernet).

Pro 21 Galea Sistena	UTP	FTP	STP
	AL 51 7758 23 7758 28 7758 30 7758 47	AL 52 7757 98 7757 99	
			AL 53 7758 41 7758 40

**2. PRESENTATION**

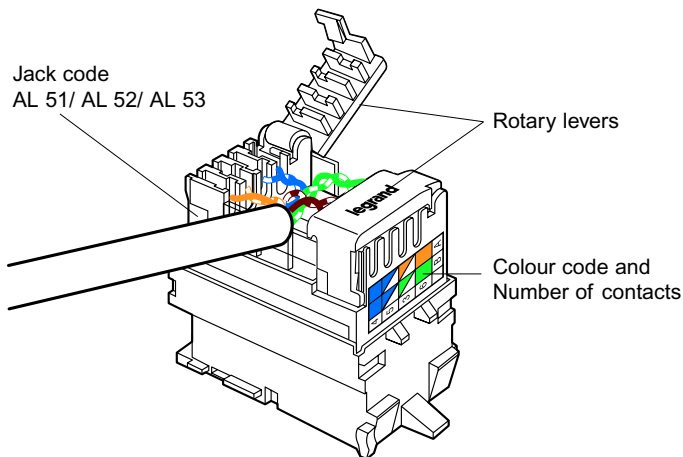

**3. MOUNTING**

Direct mounting  
 - with Legrand Galea plates and face covers

**4. TECHNICAL CHARACTERISTICS**

Contacts : gold/nickel, gold tickness > 1.27µm  
 Metal parts : Bronze (CuSn5).  
 Module insulation : ABS - Polycarbonate.  
 Cover plate: white RAL 9010

RJ 45 connectors equipped with rotary levers which do not require any special tool, and ensure error-free re-wiring.

EIA-TIA 568 A and B dual colour code on terminals

- UTP 8 contacts
- FTP 9 contacts
- STP 9 contacts + shielding cover.

Permissible conductors :

- Solid wire: 0.5 to 0.65 mm- AWG 24 to 22.
- Conductors insulation on polyethylene: Ø max on insulation : 1.5 mm.

Number of wires to attach per connection : 1  
 Max. number of connections and disconnections :  
 5 including 2 without replacing the wire.  
 Breakdown voltage ≥ 1000 V.  
 Contact resistance ≤ 20 mΩ  
 Insulation resistance ≥ 500 MΩ at 100 V DC.

Operating temperature : - 40° C to + 70° C  
 Damp heat cycle 6 days.  
 Resistance to gases (H2S and SO2).

Endurance : 750 operations (plugging in/unplugging).  
 Takes the following plugs :  
 RJ 11 (4 contacts), RJ 12 (6 contacts), RJ 45 (9 contacts).

**5. INSTALLATION INSTRUCTIONS**

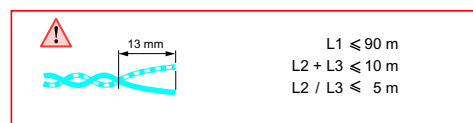
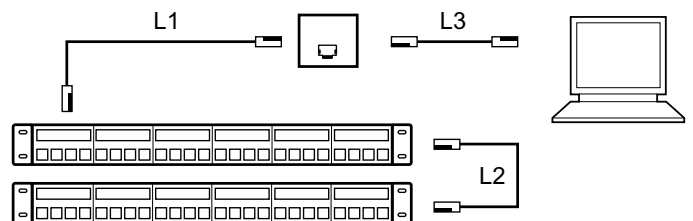

# Pro 21/Galea/Sistena socket for LCS<sup>6</sup> Category 6

Cat. No(s) : 7757 98/99  
7758 23/28/30/40/41/47

## 6. DIMENSIONS

### Front views

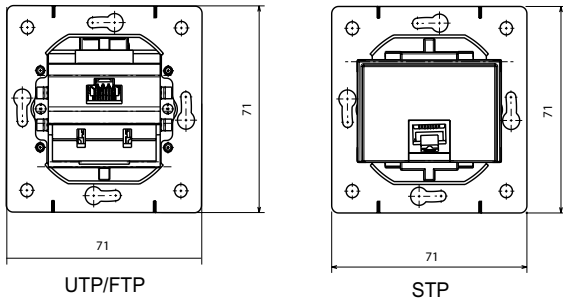

### Side views

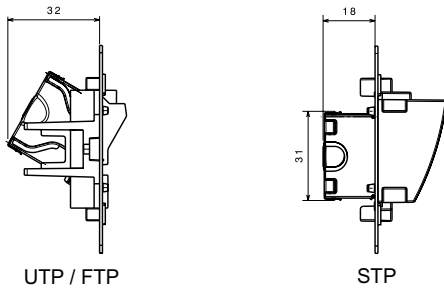

## 7. STANDARD RJ 45 CONNECTION



## 8. PERFORMANCE

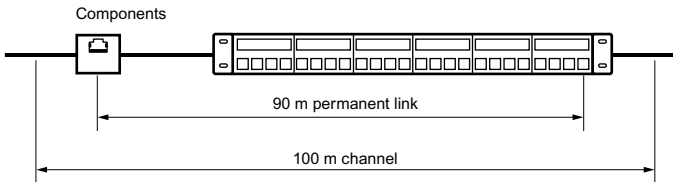

### 8.1 Performance of components (RJ 45 connectors)

#### Return loss

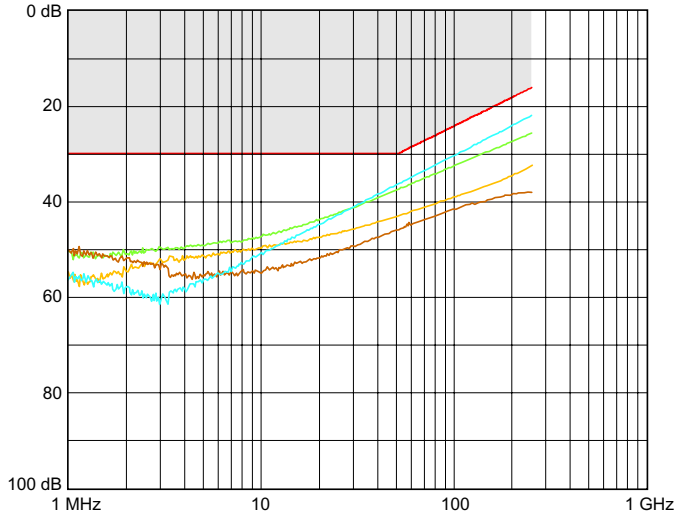

## 8. PERFORMANCE (continued)

### 8.1 Performance of components (RJ 45 connectors) (continued)

#### Attenuation

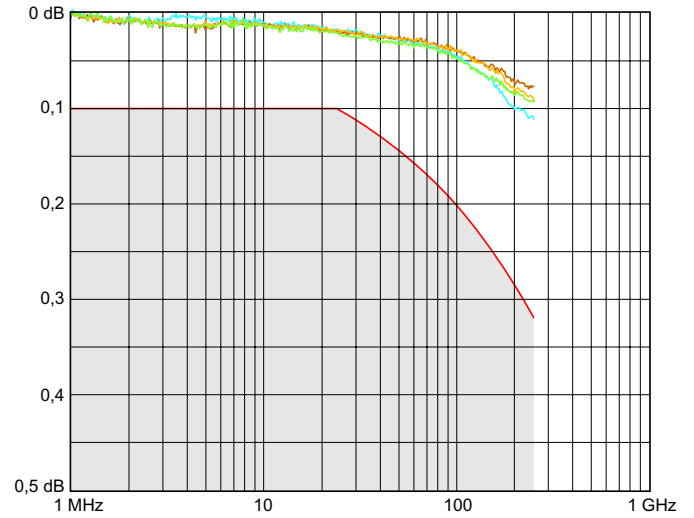

#### NEXT (Near-end Crosstalk Attenuation)

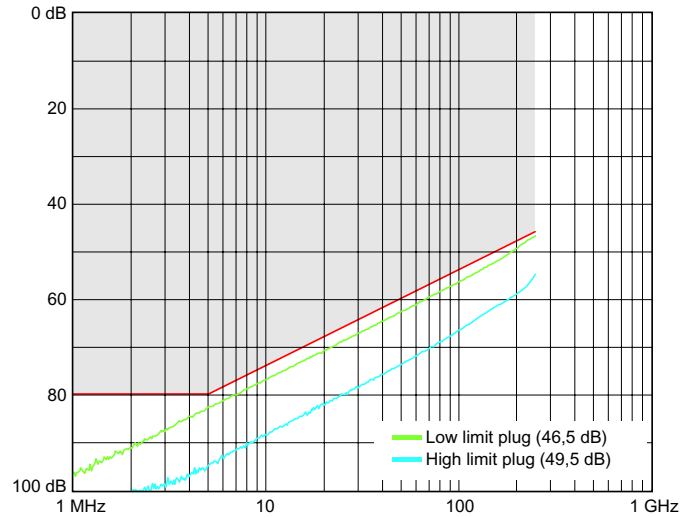

#### FEXT (Far-end Crosstalk Attenuation)

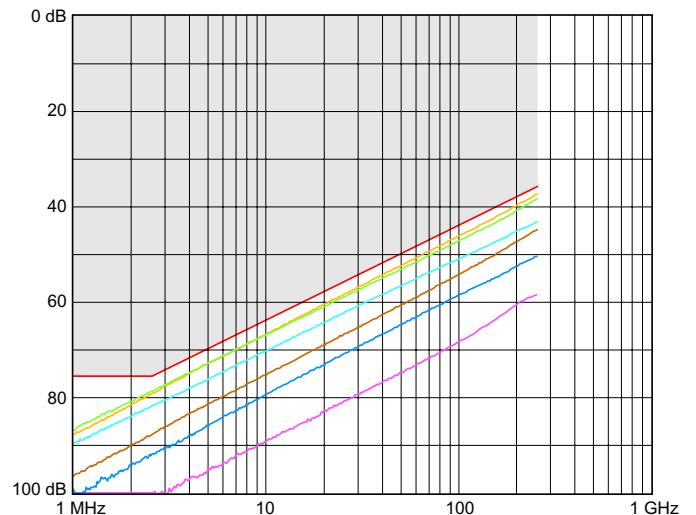

# Pro 21/Galea/Sistena socket for LCS<sup>6</sup> Category 6

Cat. No(s) : 7757 98/99  
7758 23/28/30/40/41/47

## 8. PERFORMANCE (continued)

### 8.1 Performance of components (RJ 45 connectors) (continued) TCL (Transverse Conversion Loss)

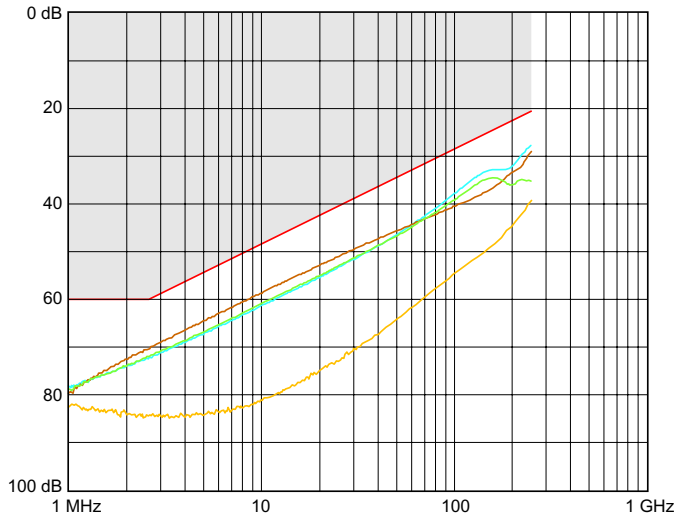

### 8.2 Permanent link performance

Return loss

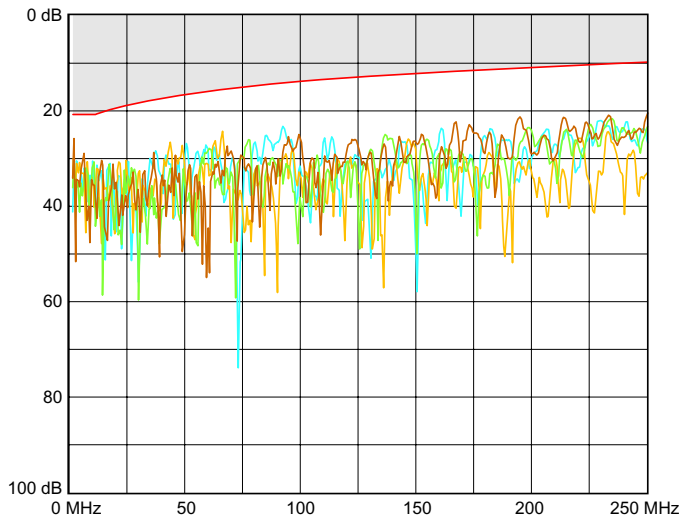

NEXT (Near-end Crosstalk Attenuation)

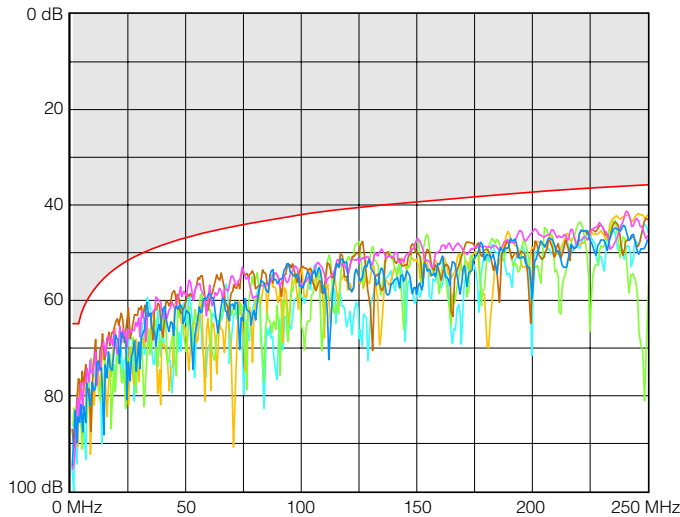

## 8. PERFORMANCE (continued)

### 8.2 Permanent link performance (continued) PS NEXT (Power sum NEXT)

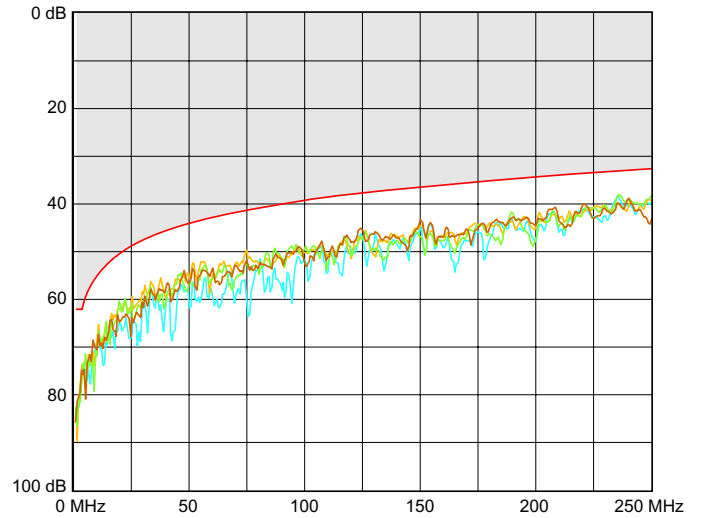

ACR (Attenuation to Crosstalk Ratio)

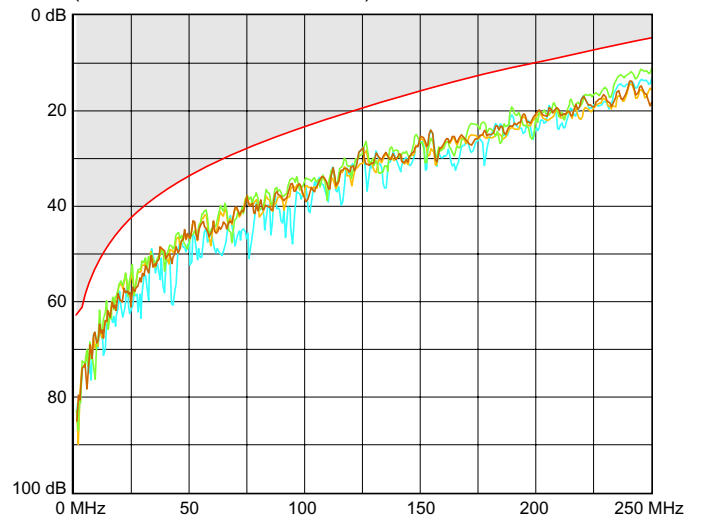

PS ACR (Power sum ACR)

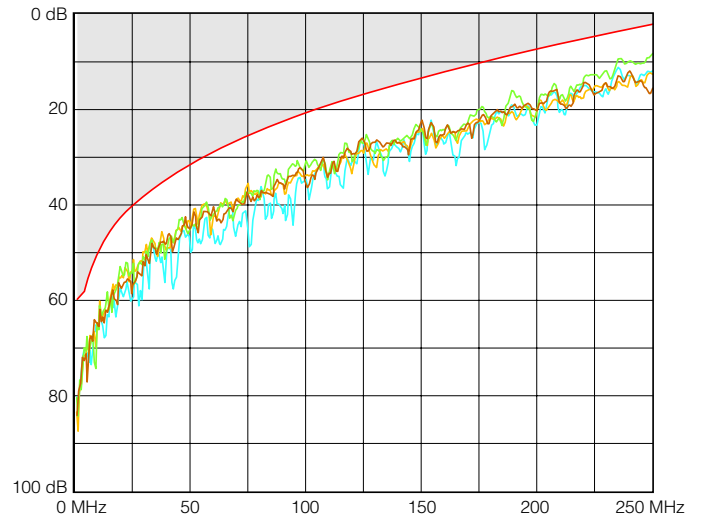

# Pro 21/Galea/Sistena socket for LCS<sup>6</sup> Category 6

Cat. No(s) : 7757 98/99  
7758 23/28/30/40/41/47

## 8. PERFORMANCE (continued)

### 8.2 Permanent link performance (continued) ELFEXT (Equal Level Far-End Crosstalk attenuation)

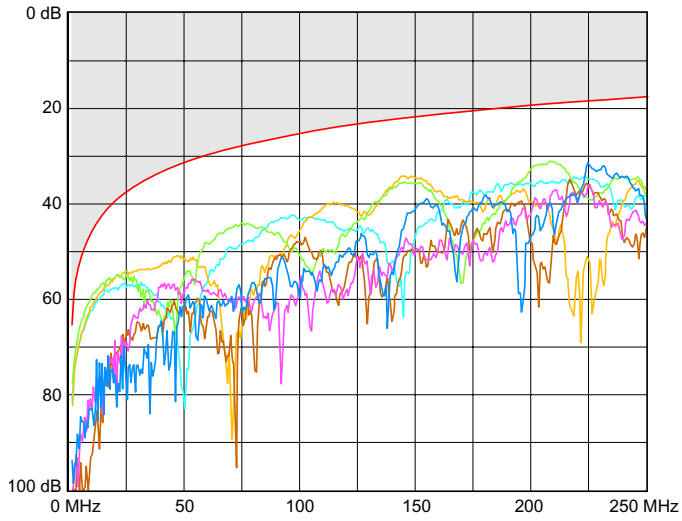

### PS ELFEXT (Power sum ELFEXT)

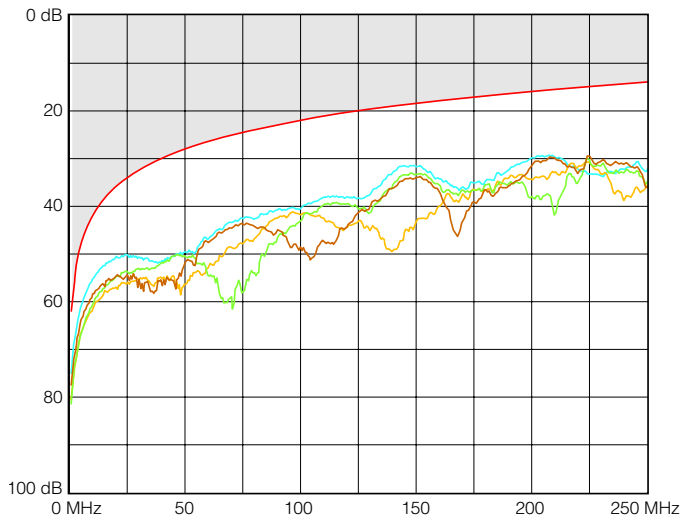

### Propagation delay

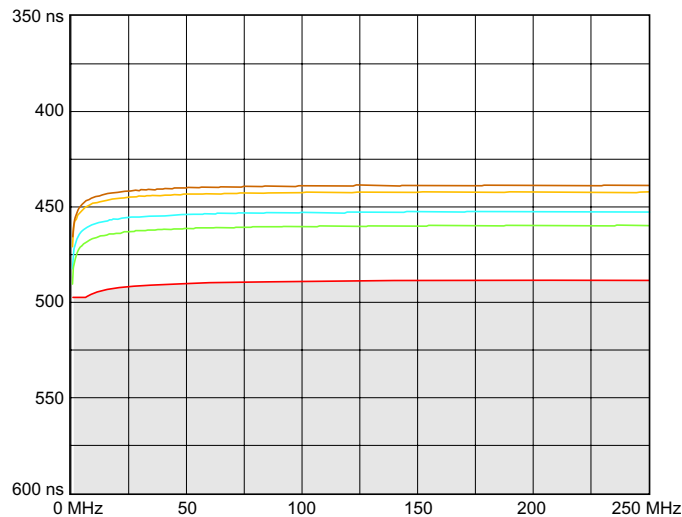

## 8. PERFORMANCE (continued)

### 8.2 Permanent link performance (continued) Delay skew

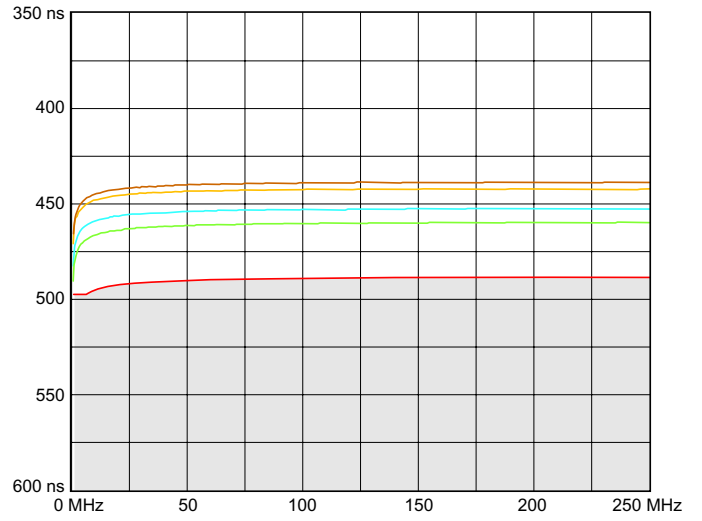

### LCL (Longitudinal Conversion Loss)

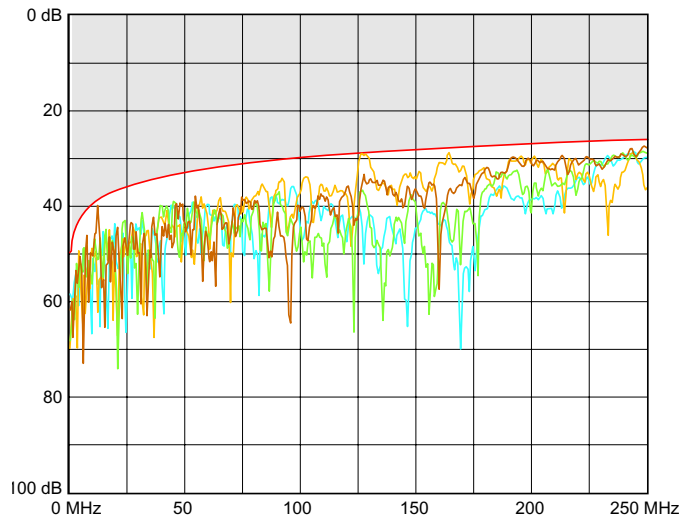

**8. PERFORMANCE (continued)**

**8.3 Channel performance**

Return loss

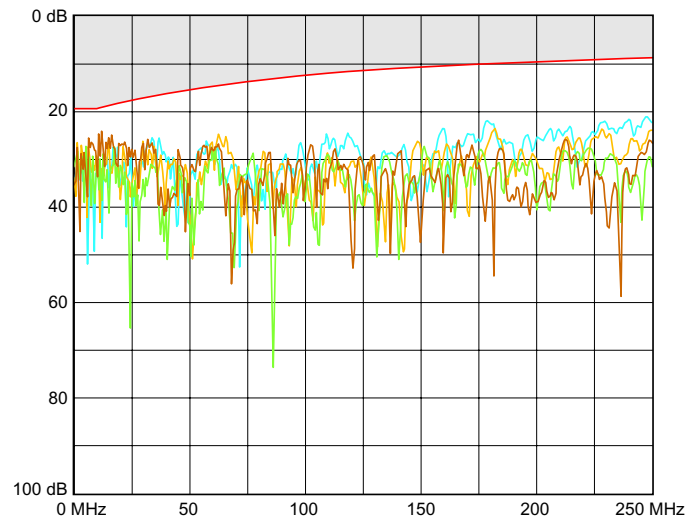

NEXT (Near end Crosstalk Attenuation)

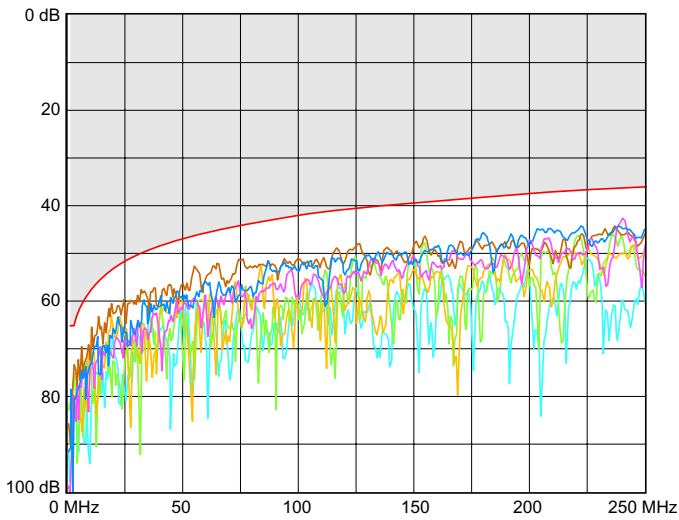

ACR (Attenuation to Crosstalk Ratio)

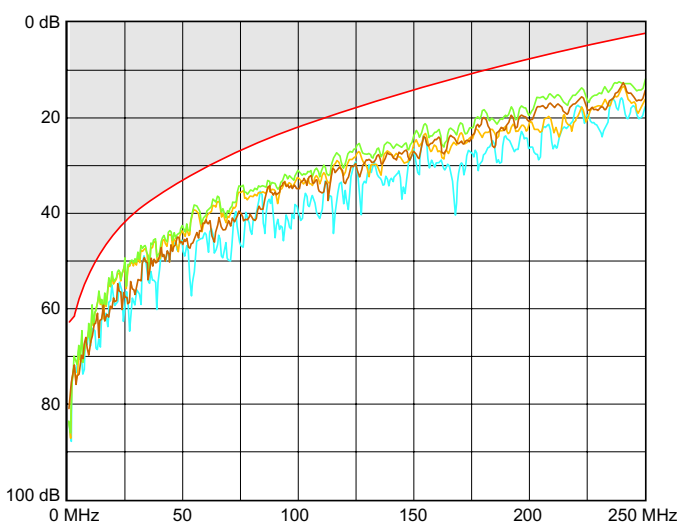

**8. PERFORMANCE (continued)**

**8.3 Channel performance (continued)**

PS ACR (Power sum ACR)

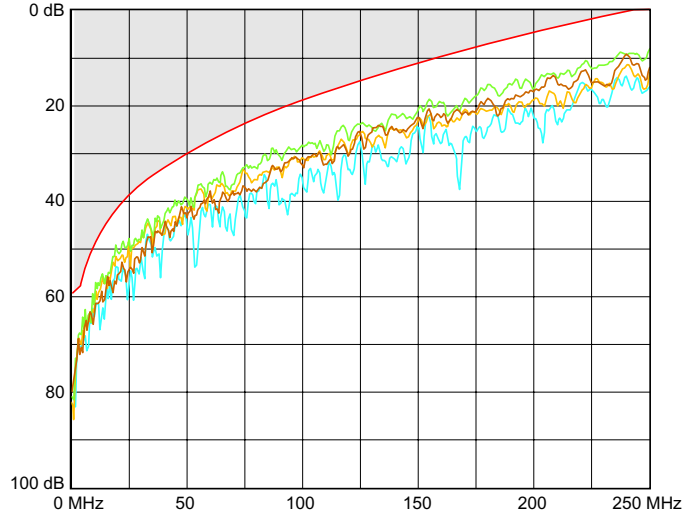

ELFEXT (Equal Level End Crosstalk attenuation)

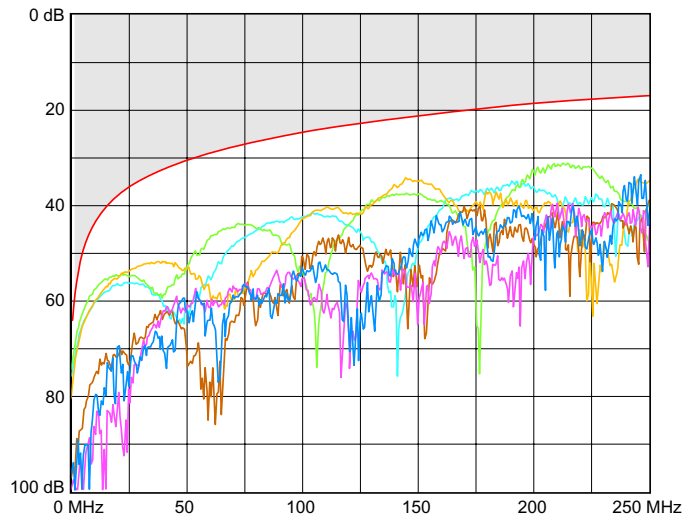

PS ELFEXT (Power sum ELFEXT)

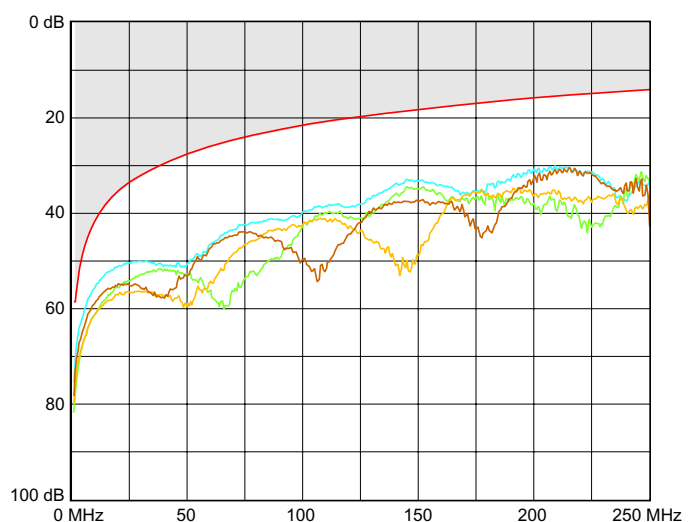

# Pro 21/Galea/Sistena socket for LCS<sup>6</sup> Category 6

Cat. No(s) : 7757 98/99  
7758 23/28/30/40/41/47

## 8. PERFORMANCE (continued)

### 8.3 Channel performance (continued)

Propagation delay

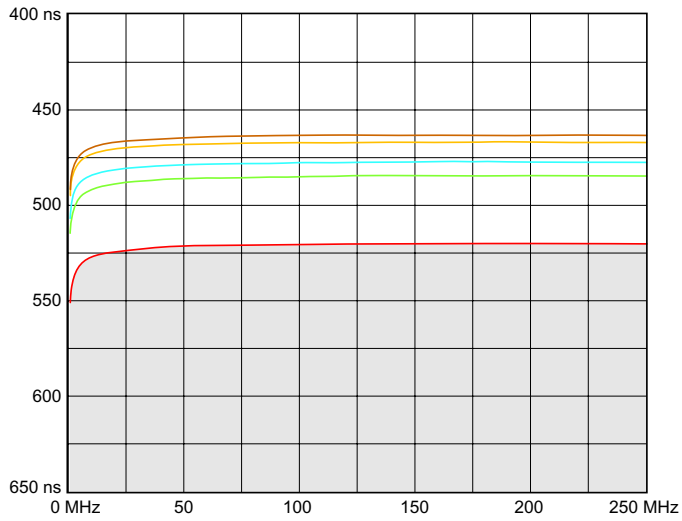

Delay skew

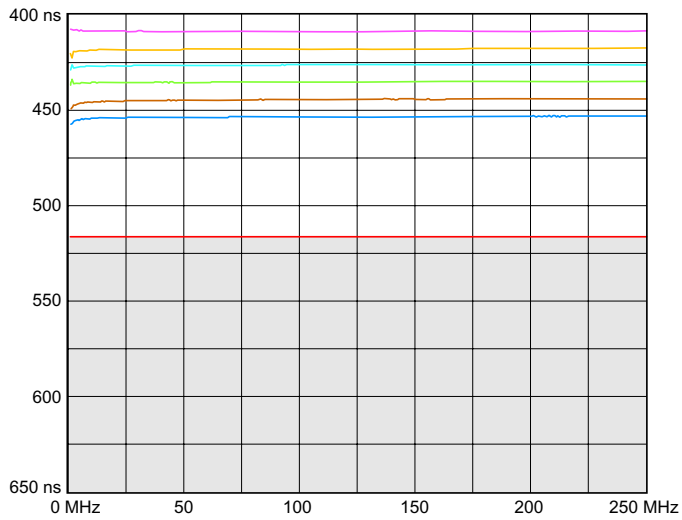

LCL (Longitudinal Conversion Loss)

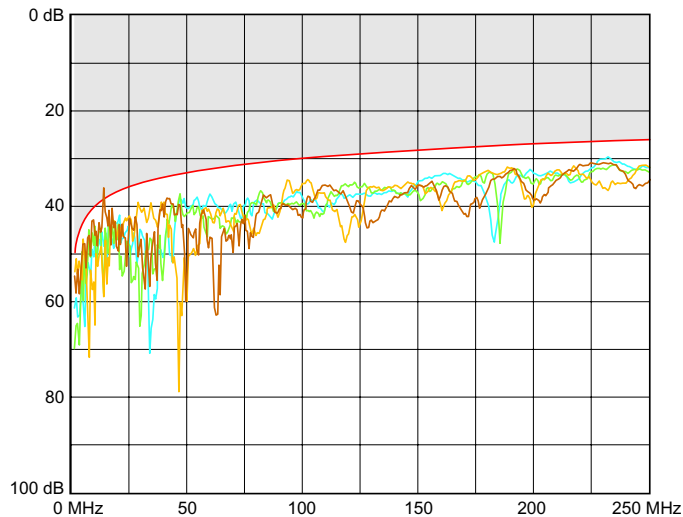

## 9. STANDARDS AND APPROVALS

Conforming to the following standards

ISO 11 801 Second edition

EN 50 173 Second edition

EIA / TIA - 568 - B.2

NFC 20 730

Standard 8877 - 603.7

3P approval no. : 102 180