

NT 041 571/00

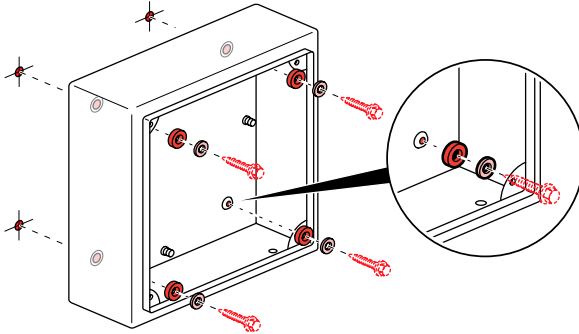

 x 4

 x 4

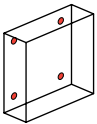
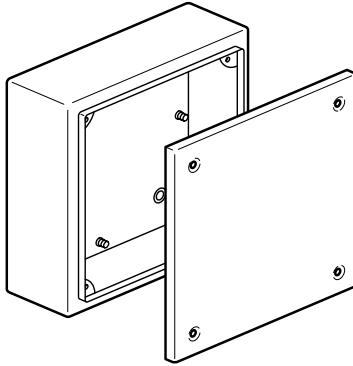
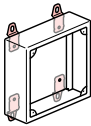
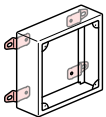

364 07

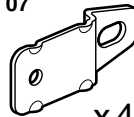

x 4



4 x M6

 x 4

 x 4

1

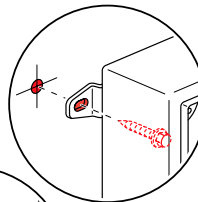
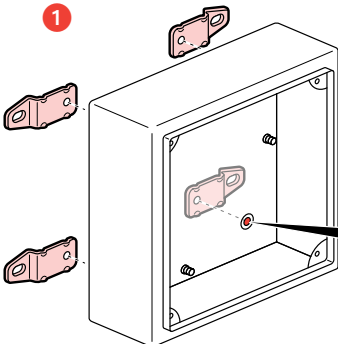

2

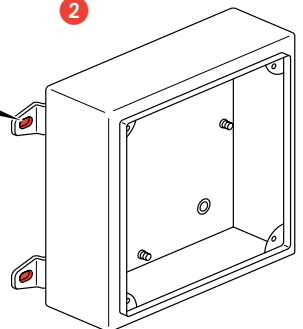

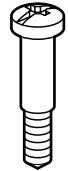
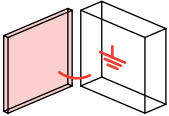
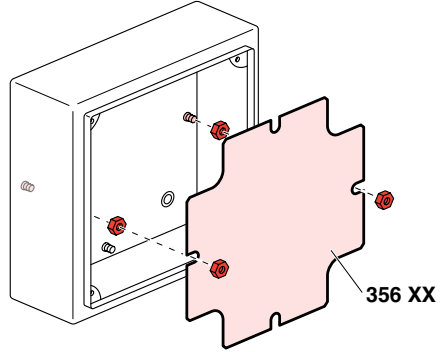
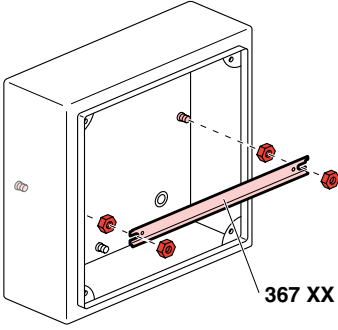
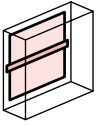

1

2

