









	29 V _~
	16 mA
	4 x (Ø 0,6 mm <  < Ø 0,8 mm)
	-5°C → +45°C
	 PIR / US
	500 lux
	15 mn
	Auto ON/OFF
	PIR/US: Ø 8 m







1

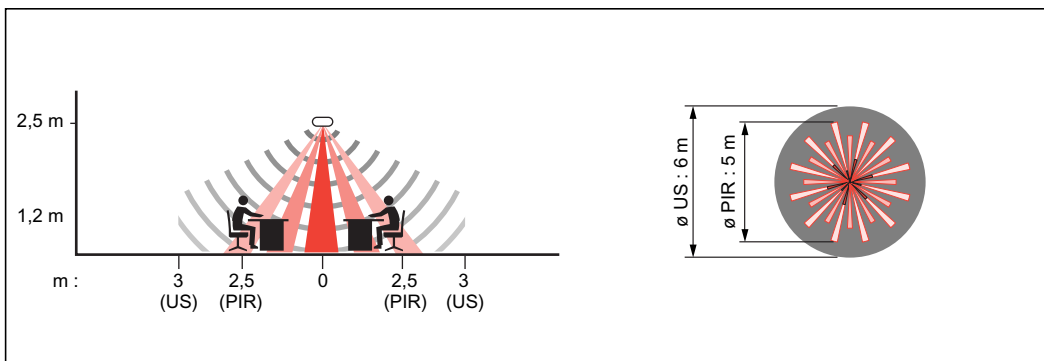
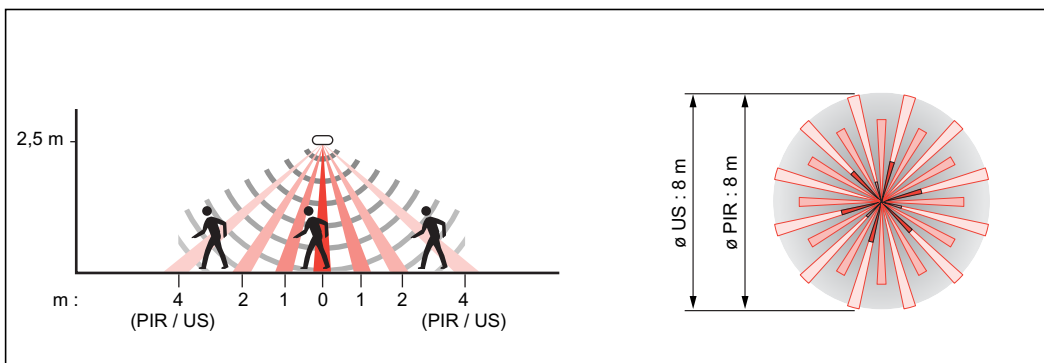
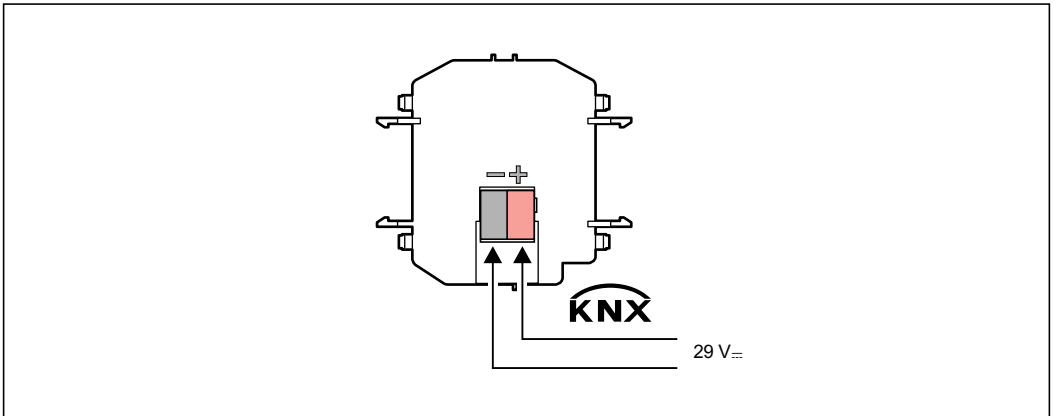
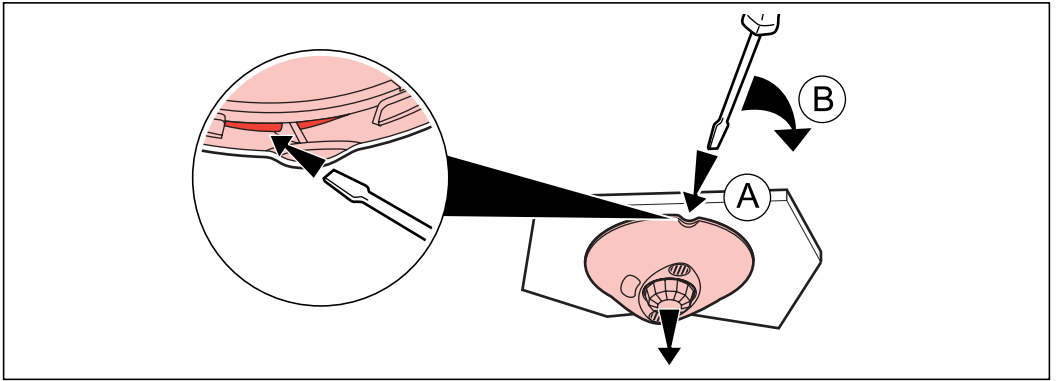
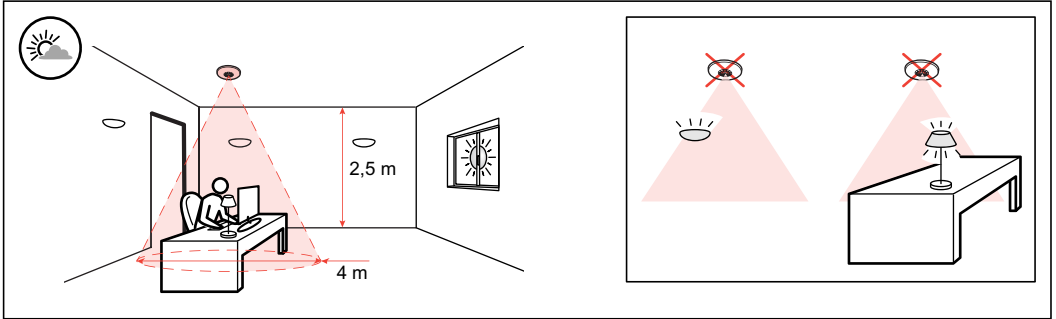
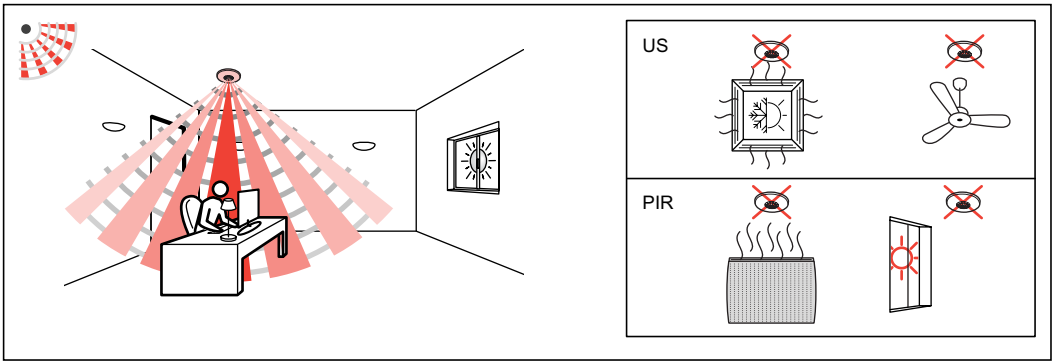
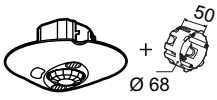

2

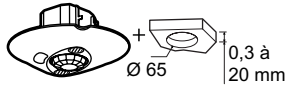
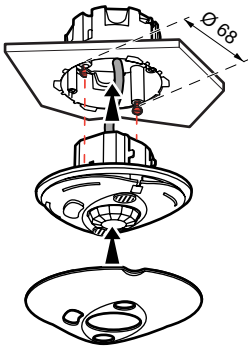

1



2

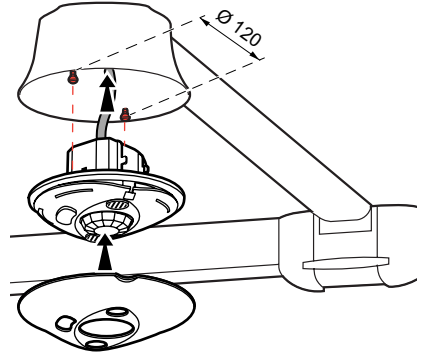
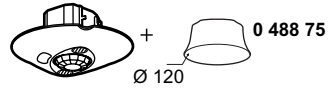
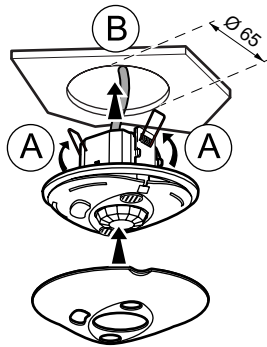



Auto ON/OFF

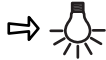

Manual ON / Auto OFF

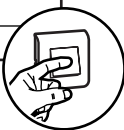
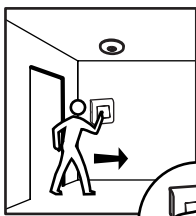

www.legrandoc.com

	5 - 1275 lux
	5 sec - 17 h 59 min 59 sec
	25% - 50% - 75% - 100%
Mode	Auto ON/OFF - Manual On/Auto OFF - Walkthrough

- Bouton de prog. KNX
- KNX prog. push-button
- Pulsante prog. KNX

- Capteur PIR
- PIR sensor
- Sensore PIR

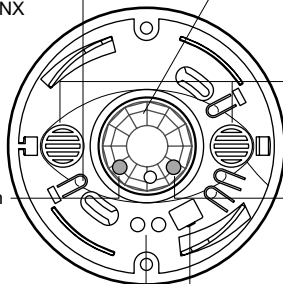

- Détecteur US
- US sensor
- Sensore US

- LED de détection
- Presence LED
- LED rilevazione presenza

- LED KNX
- KNX LED
- LED KNX

- LED d'émission/de réception IR
- IR reception/transmission LED
- LED ricezione/trasmissione IR

- Cache de protection
- Protection
- Protezione



* 0 882 30
BMSO4001

* Version minimum du firmware 2.5.6, mise à jour disponible sur www.legrandoc.com

• Minimum version of 2.5.6 firmware update available on www.legrandoc.com

• Versione minima del firmware 2.5.6, software di aggiornamento disponibile su www.legrandoc.com

