

- Do not stare into LED light beam.
- The luminaire shall be installed by a qualified electrician and wired in accordance with the latest IEE electrical regulations or the national requirements.
- The light source contained in this luminaire shall only be replaced by the manufacturer or his service agent or a similar qualified person.
- Above average concentration of sulfur effects the useful lifetime of the product. E.g: Light color changes from white to blue. Typically in chicken & pig farms.
- For use in environments where an accumulation of conductive dust on the luminaire may be expected
- Do not install the luminaire on the location where it is exposed to heavily grease, esp. mineral oil and distillates (petroleum), heavy naphthenic treated with hydrogen.
- This product is not suitable for cold & humid storage areas, especially where obvious temperature gradients are present, such as ventilation opening, door, etc.
- Do not install the luminaire on locations where it is exposed to direct sunlight. UV radiation will damage the material over time resulting in loss of waterproof sealing and IP65 rating.

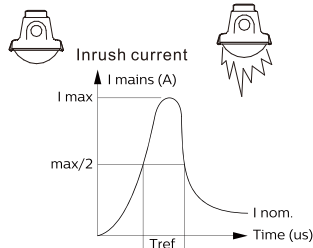

	LED19S LED18S	LED27S LED25S	LED40S LED37S	LED34S LED31S	LED60S LED57S	LED80S LED75S
Driver I peak [A]	3.58	3.58	14.2	5.16	14.2	15
Driver Tref [µs]	40	40	222	47	222	240
Max. Nr. of connecting products by MCB type						
MCB 16A type B	80	80	36	60	36	31
MCB 10A type B	50	50	22	37	22	19
MCB 16A type C	136	136	60	102	60	52
MCB 10A type C	80	80	37	62	37	32
Max. Nr. of connecting products by through wire cross-section area						
1.0 mm ²	45	33	23	27	16	11
1.5 mm ²	67	49	35	41	23	18
2.5 mm ²	112	82	59	69	39	29
According to MCB type & through wire cross-section area, choose the minimum number to connect products.						



© 05/2023 Signify Holding.
All rights reserved. This document contains information relating to the product portfolio of Signify which information may be subject to change. No representation or warranty as to the accuracy or completeness of the information included herein is given and any liability for any action in reliance thereon is disclaimed. The information presented in this document is not intended as any commercial offer and does not form part of any quotation or contract. Philips and the Philips Shield Emblem are registered trademarks of Koninklijke Philips N.V.. All other trademarks are owned by Signify Holding or their respective owners.

Signify Holding.
The Netherlands

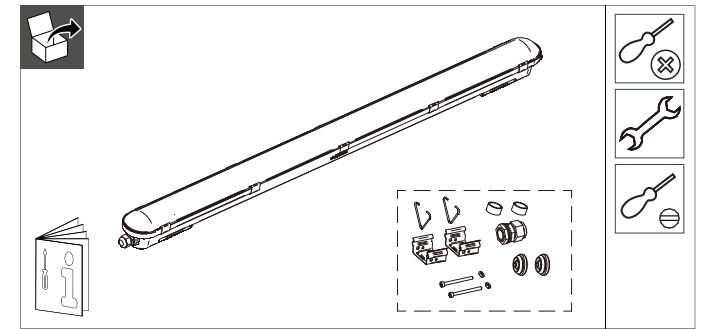

	System light output(Lm)	Color temperature(K)	Power(W)	Energy Efficiency Class of Light source	kg
WT120C G2 LED19S/840 PSU L600	1900	4000K	15	D	0.8
WT120C G2 LED27S/840 PSU L1200	2700	4000K	20.5	D	1.33
WT120C G2 LED40S/840 PSU L1200	4000	4000K	28.6	D	1.33
WT120C G2 LED34S/840 PSU L1500	3400	4000K	24.3	D	1.65
WT120C G2 LED60S/840 PSU L1500	6000	4000K	42.9	D	1.67
WT120C G2 LED80S/840 PSU L1500	8000	4000K	57.1	D	1.73
WT120C G2 LED18S/840 PSU PCO L600	1800	4000K	15	D	0.8
WT120C G2 LED25S/840 PSU PCO L1200	2500	4000K	20.5	D	1.33
WT120C G2 LED37S/840 PSU PCO L1200	3700	4000K	28.6	D	1.33
WT120C G2 LED31S/840 PSU PCO L1500	3100	4000K	24.3	D	1.65
WT120C G2 LED57S/840 PSU PCO L1500	5700	4000K	42.9	D	1.67
WT120C G2 LED75S/840 PSU PCO L1500	7500	4000K	57.1	D	1.73
WT120C G2 LED40S/865 PSU L1200	4000	6500K	28.5	D	1.33
WT120C G2 LED34S/865 PSU L1500	3400	6500K	24.5	D	1.65
WT120C G2 LED60S/865 PSU L1500	6000	6500K	43	D	1.67
WT120C G2 LED37S/830 PSU L1200	3700	3000K	28.5	D	1.33
WT120C G2 LED55S/830 PSU L1500	5500	3000K	43	D	1.67

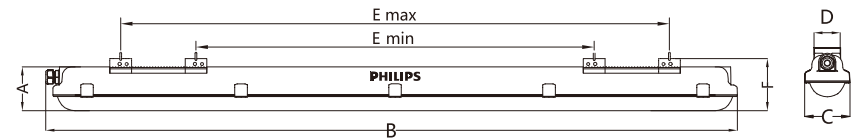

Type	Dimension(mm)						Nr. of clips
	A	B	C	D	E min	E max	
WT120C G2 LED19S/840 PSU L600 / WT120C G2 LED18S/840 PSU PCO L600		665			308	512	6
WT120C G2 LED27S/840 PSU L1200 / WT120C G2 LED25S/840 PSU PCO L1200		1215			538	1062	10
WT120C G2 LED40S/840 PSU L1200 / WT120C G2 LED37S/840 PSU PCO L1200							
WT120C G2 LED34S/840 PSU L1500 / WT120C G2 LED31S/840 PSU PCO L1500	76	1515	80	38	838	1362	85
WT120C G2 LED60S/840 PSU L1500 / WT120C G2 LED57S/840 PSU PCO L1500							
WT120C G2 LED80S/840 PSU L1500 / WT120C G2 LED75S/840 PSU PCO L1500							
WT120C G2 LED40S/865 PSU L1200 / WT120C G2 LED37S/830 PSU L1200		1215			538	1062	10
WT120C G2 LED34S/865 PSU L1500 /							
WT120C G2 LED60S/865 PSU L1500 / WT120C G2 LED55S/830 PSU L1500		1515			838	1362	12

444170173404

