



side wall mounted rot. operator standard IEC IP65 accessory for:
3VA1 100/160



Model	
Product brand name	SENTRON
Product designation	Accessories
Product version	Side wall-mounted rotary operator
Accessories	Side panel rotary operating mechanism
General technical data	
Protection class IP	IP65
Mechanical Design	
Height	70 mm
Net weight	644 g
Certificates	

General Product Approval	EMC	Declaration of Conformity	Test Certificates
 VDE	Miscellaneous EAC	 RCM	 EG-Konf.

[Type Test Certificates/Test Report](#)

Shipping Approval	other
-------------------	-------



LRS

[Manufacturer Declaration](#)

[Miscellaneous](#)

Further information

Information- and Downloadcenter (Catalogs, Brochures,...)

<http://www.siemens.com/lowvoltage/catalogs>

Industry Mall (Online ordering system)

<https://mall.industry.siemens.com/mall/en/en/Catalog/product?mlfb=3VA9157-0PK11>

Service&Support (Manuals, Certificates, Characteristics, FAQs,...)

<https://support.industry.siemens.com/cs/ww/en/ps/3VA9157-0PK11>

Image database (product images, 2D dimension drawings, 3D models, device circuit diagrams, ...)

http://www.automation.siemens.com/bilddb/cax_en.aspx?mlfb=3VA9157-0PK11

CAX-Online-Generator

<http://www.siemens.com/cax>

Tender specifications

<http://www.siemens.com/specifications>

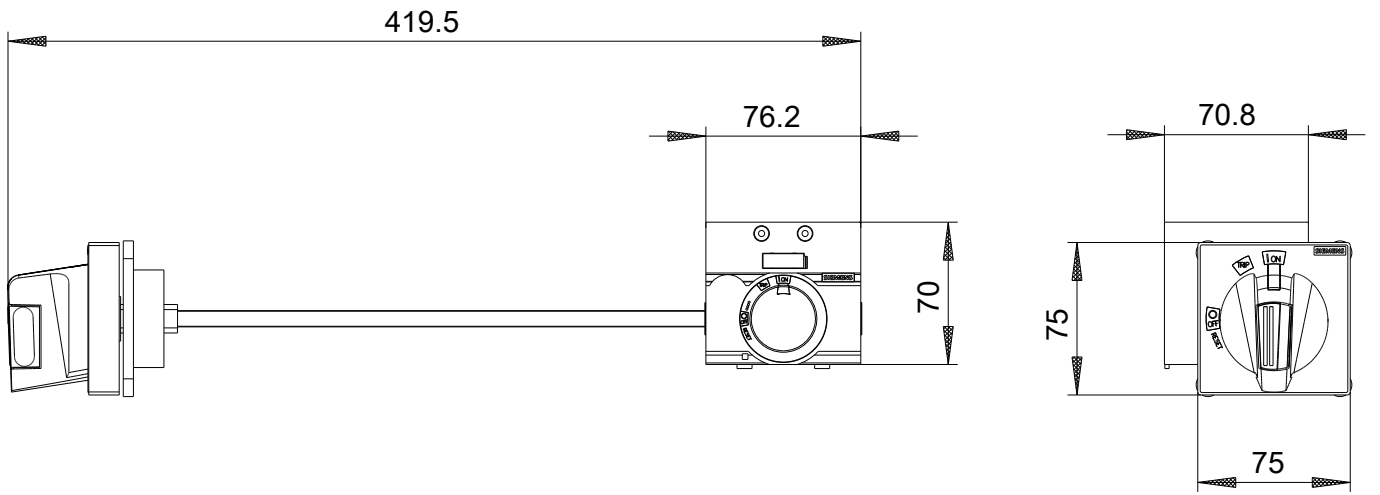

last modified:

08/08/2020