

Door mounted rotary operator standard, rigid without tolerance adapter IEC IP65 with door interlocking accessory for: 3VA1 400/630 3VA2 400/630

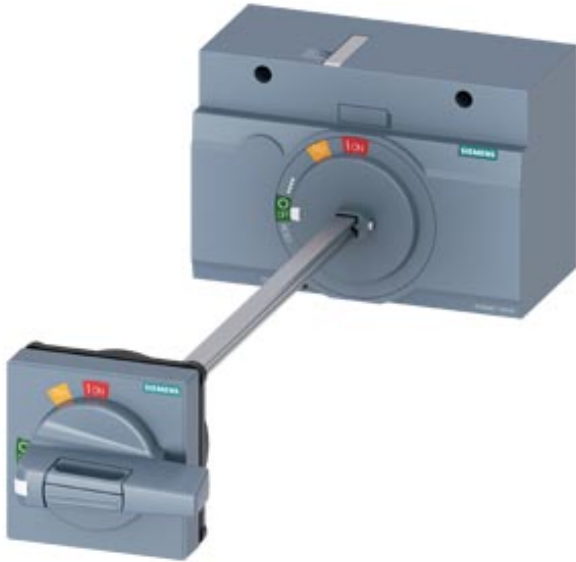





Model	
Product brand name	SETRON
Product designation	Accessories
Product version	Door-coupling rotary operating mechanism
Accessories	Door-coupling rotary operating mechanisms

General technical data	
Protection class IP	IP65

Mechanical Design	
Height	94 mm
Width	138 mm
Net weight	676 g

Certificates

General Product Approval	EMC	Declaration of Conformity	Shipping Approval	other
Miscellaneous 	 RCM	 EG-Konf.	 LRS	Manufacturer Declaration

other
Miscellaneous

Further information

Information- and Downloadcenter (Catalogs, Brochures,...)

<http://www.siemens.com/lowvoltage/catalogs>

Industry Mall (Online ordering system)

<https://mall.industry.siemens.com/mall/en/en/Catalog/product?mlfb=3VA9467-0FK61>

Service&Support (Manuals, Certificates, Characteristics, FAQs,...)

<https://support.industry.siemens.com/cs/ww/en/ps/3VA9467-0FK61>

Image database (product images, 2D dimension drawings, 3D models, device circuit diagrams, ...)

http://www.automation.siemens.com/bilddb/cax_en.aspx?mlfb=3VA9467-0FK61

CAX-Online-Generator

<http://www.siemens.com/cax>

Tender specifications

<http://www.siemens.com/specifications>

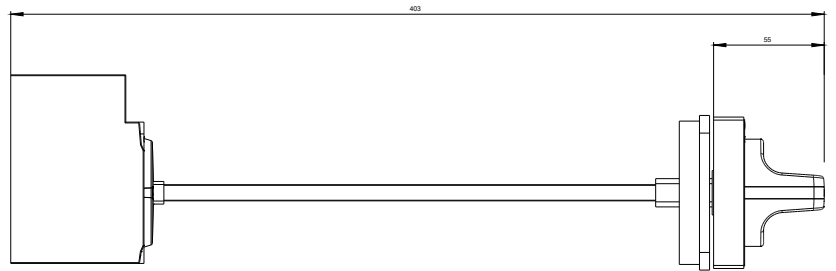
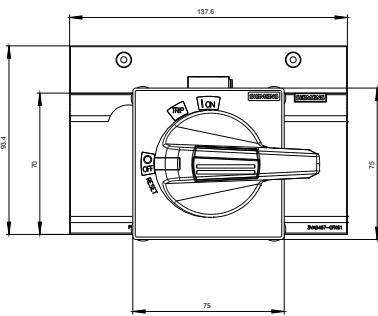

last modified:

08/08/2020