

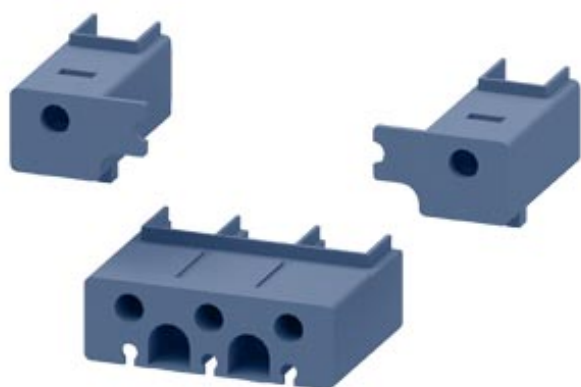







kryt pro rámové svorky, 4pól., stykač, konstrukční velikost S2



Název značky produktu	SIRIUS
označení produktu	kryt

### Schválení Osvědčení

General Product Approval	EMC	Declaration of Conformity	Marine / Shipping
 UL	 EAC	 RCM	 EG-Konf.
			<a href="#">Miscellaneous</a>  BUREAU VERITAS
Marine / Shipping	other		
 PRS	 RMRS	 TYPE APPROVED PRODUCT DNV-GL DNVGL.COM/AF	<a href="#">Confirmation</a>

### Další informace

Informace- a Stáhnout Center  
<https://www.siemens.com/ic10>

**Industry Mall (online objednávkový systém)**

<https://mall.industry.siemens.com/mall/cs/cs/Catalog/product?mlfb=3RT2936-4EA4>

**CAX Online generátor**

<http://support.automation.siemens.com/WW/CAXorder/default.aspx?lang=en&mlfb=3RT2936-4EA4>

**Služba&Podpora (Manuály, Návod k obsluze, Certifikáty, Vlastnosti, FAQs, ...)**

<https://support.industry.siemens.com/cs/ww/en-CS/ps/3RT2936-4EA4>

**Databáze obrázků (Fotografie produktu, 2D Výkresy rozměr, 3D Modely, Schéma zapojení vnitřních obvodů, EPLAN**

**Makra, ...)**

[http://www.automation.siemens.com/bilddb/cax\\_de.aspx?mlfb=3RT2936-4EA4&lang=en](http://www.automation.siemens.com/bilddb/cax_de.aspx?mlfb=3RT2936-4EA4&lang=en)

**Charakteristiky: Spouštění chování, I<sup>2</sup>t, vpřed proud**

<https://support.industry.siemens.com/cs/ww/en/ps/3RT2936-4EA4/char>

**Více charakteristik (např. Elektrický život, Spínací frekvence)**

<http://www.automation.siemens.com/bilddb/index.aspx?view=Search&mlfb=3RT2936-4EA4&objecttype=14&gridview=view1>

