

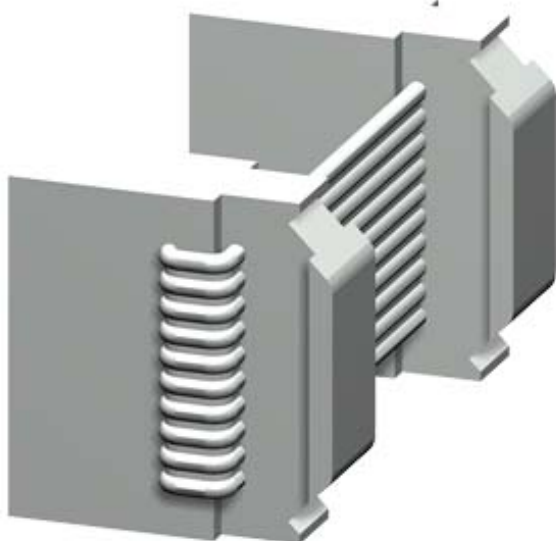





spojovací kabel délka 0,3 m, plochý, pro připojení základního přístroje, modulu pro zaznamenávání proudu, modulu pro zaznamenávání proudu/napětí, ovládacího prvku nebo rozšiřujících modulů přes systémové rozhraní







## Obecné technické údaje

Název značky produktu	SIRIUS
označení produktu	spojovací kabel
provedení produktu	délka 0,3 m, ploché
okolní teplota	
• během skladování	-40 ... +80 °C
• během provozu	-25 ... +60 °C
• během přepravy	-40 ... +80 °C

## Schválení/ Osvědčení

General Product Approval	EMC	Declaration of Conformity	Test Certificates	Shipping Approval
 UL		 RCM	 EG-Konf.	<a href="#">Type Test Certificates/Test Report</a>  ABS

Shipping Approval	other			
 LRS	 PRS	 RMRS	<a href="#">Confirmation</a>	<a href="#">PROFINET-Certification</a>  Profibus

#### Další informace

##### Informace- a Stáhnout Center

<https://www.siemens.com/ic10>

##### Industry Mall (online objednávkový systém)

<https://mall.industry.siemens.com/mall/cs/cs/Catalog/product?mlfb=3UF7935-0AA00-0>

##### CAX Online generátor

<http://support.automation.siemens.com/WW/CAXorder/default.aspx?lang=en&mlfb=3UF7935-0AA00-0>

##### Služba&Podpora (Manuály, Návod k obsluze, Certifikáty, Vlastnosti, FAQs, ...)

<https://support.industry.siemens.com/cs/ww/en-CS/ps/3UF7935-0AA00-0>

##### Databáze obrázků (Fotografie produktu, 2D Výkresy rozměr, 3D Modely, Schéma zapojení vnitřních obvodů, EPLAN

##### Makra, ...)

[http://www.automation.siemens.com/bilddb/cax\\_de.aspx?mlfb=3UF7935-0AA00-0&lang=en](http://www.automation.siemens.com/bilddb/cax_de.aspx?mlfb=3UF7935-0AA00-0&lang=en)

