

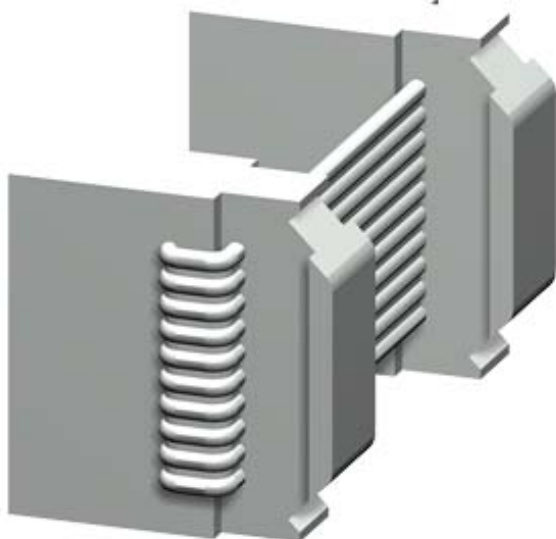





spojovací kabel délka 0,1 m, plochý, pro připojení základního přístroje, modulu pro zaznamenávání proudu, modulu pro zaznamenávání proudu/napětí, ovládacího prvku nebo rozšiřujících modulů přes systémové rozhraní







Obecné technické údaje

| | |
|-----------------------|---------------------|
| Název značky produktu | SIRIUS |
| označení produktu | spojovací kabel |
| provedení produktu | délka 0,1 m, ploché |
| okolní teplota | |
| • během skladování | -40 ... +80 °C |
| • během provozu | -25 ... +60 °C |
| • během přepravy | -40 ... +80 °C |

Schválení/ Osvědčení

| General Product Approval | | EMC | Declaration of Conformity | Test Certificates |
|--|---|---|--|---|
|  CSA |  UL |  |  RCM |  EG-Konf. |

[Type Test Certificates/Test Report](#)

| Shipping Approval | | | | other | |
|--|--|--|---|------------------------------|--|
|  ABS |  LRS |  PRS |  RMRS | Confirmation | PROFINET-Certification |

other



Profibus

Další informace

Informace- a Stáhnout Center

<https://www.siemens.com/ic10>

Industry Mall (online objednávkový systém)

<https://mall.industry.siemens.com/mall/cs/cs/Catalog/product?mlfb=3UF7931-0AA00-0>

CAX Online generátor

<http://support.automation.siemens.com/WW/CAXorder/default.aspx?lang=en&mlfb=3UF7931-0AA00-0>

Služba&Podpora (Manuály, Návod k obsluze, Certifikáty, Vlastnosti, FAQs, ...)

<https://support.industry.siemens.com/cs/ww/en-CS/ps/3UF7931-0AA00-0>

Databáze obrázků (Fotografie produktu, 2D Výkresy rozměr, 3D Modely, Schéma zapojení vnitřních obvodů, EPLAN

Makra, ...)

http://www.automation.siemens.com/bilddb/cax_de.aspx?mlfb=3UF7931-0AA00-0&lang=en

