

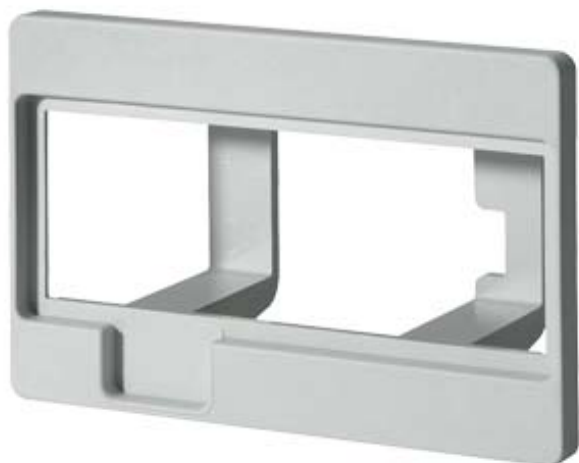









adaptér, pro ovládací modul 3UF720



Obecné technické údaje

Název značky produktu	SIRIUS
označení produktu	adaptér pro ovládací modul
provedení produktu	umožňuje použít menší ovládací prvek 3UF7200
Druh krytí IP	IP54
okolní teplota	
• během skladování	-40 ... +80 °C
• během provozu	-25 ... +60 °C
• během přepravy	-40 ... +80 °C

Schválení/ Osvědčení

General Product Approval			EMC	Declaration of Conformity	Test Certificates
 CSA	 UL		 RCM	 EG-Konf.	Type Test Certificates/Test Report
Shipping Approval			other		
 ABS	 LRS	 RMRS	Confirmation	 Profibus	PROFINET-Certification

Další informace

Informace- a Stáhnout Center

<https://www.siemens.com/ic10>

Industry Mall (online objednávkový systém)

<https://mall.industry.siemens.com/mall/cs/cs/Catalog/product?mlfb=3UF7922-0AA00-0>

CAX Online generátor

<http://support.automation.siemens.com/WW/CAXorder/default.aspx?lang=en&mlfb=3UF7922-0AA00-0>

Služba&Podpora (Manuály, Návod k obsluze, Certifikáty, Vlastnosti, FAQs, ...)

<https://support.industry.siemens.com/cs/ww/en-CS/ps/3UF7922-0AA00-0>

Databáze obrázků (Fotografie produktu, 2D Výkresy rozměr, 3D Modely, Schéma zapojení vnitřních obvodů, EPLAN

Makra, ...)

http://www.automation.siemens.com/bilddb/cax_de.aspx?mlfb=3UF7922-0AA00-0&lang=en

