







kabelová sada pružina elektrická a mechanická
elektrická a mechanická pro reverzační spouštěč S2



Obecné technické údaje		
Název značky produktu		SIRIUS
označení produktu		elektroinstalační sada
provedení produktu		Ovládací napětí stykače: AC a DC
konstrukční velikost výkonového jističe		S2
konstrukční velikost stykače		S2
součást produktu zapojovací modul dolní		Ano
součást produktu zapojovací modul horní		Ano
Schválení/ Osvědčení		

General Product Approval	Declaration of Conformity	Test Certificates	Shipping Approval
 CSA	 EAC	 EG-Konf.	Miscellaneous Type Test Certificates/Test Report  ABS

Shipping Approval	other
 BUREAU VERITAS	 PRS
 RINA	Confirmation

Další informace

Informace- a Stáhnout Center

<https://www.siemens.com/ic10>

Industry Mall (online objednávkový systém)

<https://mall.industry.siemens.com/mall/cs/cs/Catalog/product?mlfb=3RA2933-2AA2>

CAX Online generátor

<http://support.automation.siemens.com/WW/CAXorder/default.aspx?lang=en&mlfb=3RA2933-2AA2>

Služba&Podpora (Manuály, Návod k obsluze, Certifikáty, Vlastnosti, FAQs, ...)

<https://support.industry.siemens.com/cs/ww/en-CS/ps/3RA2933-2AA2>

Databáze obrázků (Fotografie produktu, 2D Výkresy rozměr, 3D Modely, Schéma zapojení vnitřních obvodů, EPLAN

Makra, ...)

http://www.automation.siemens.com/bilddb/cax_de.aspx?mlfb=3RA2933-2AA2&lang=en

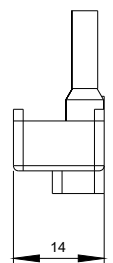
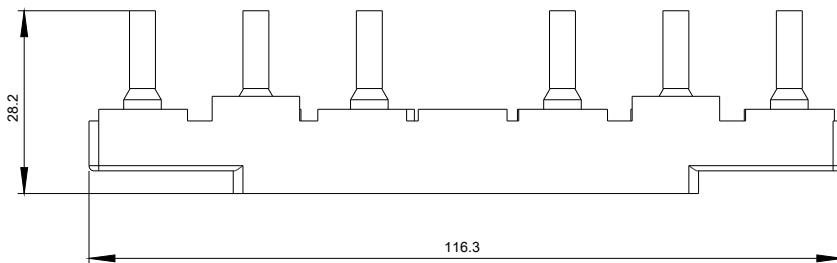
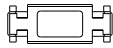
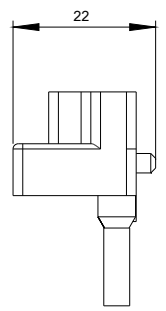
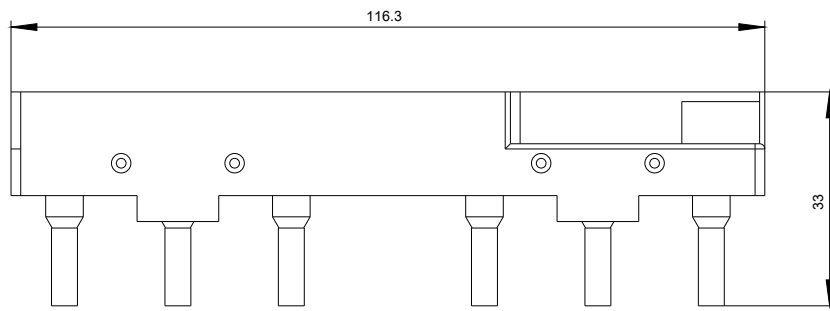

Poslední změna:

25.11.2020