



Data

Elektrické parametry

Ratings per IEC/EN 60664-1

Návrhové napětí (III / 3)	800 V
Jmenovitý proud	14 A

Approvals Ex

Jmenovitý proud (Ex e II)	12 A
---------------------------	------



Geometrické údaje

Šířka	20 mm / 0.787 inch
Výška	19 mm / 0.748 inch
Hloubka	4,1 mm / 0.161 inch

Údaje o materiálu

barva	Světle šedá
Požární zatížení	0.011 MJ
Hmotnost	1.12 g

Obchodní údaje

Product Group	22 (TOPJOB S)
Druh balení	bag
Country of origin	DE
GTIN	4055143697293
Customs Tariff No.	85366990990

Ke stažení

Documentation

Additional Information

Technical explanations	03-Apr-2019	pdf 2,1 MB	Stáhnout
------------------------	-------------	---------------	----------

CAD/CAE-Data

CAD data

2D/3D Models 2000-436	URL	Stáhnout
-----------------------	-----	----------

CAE data

EPLAN Data Portal 2000-436	Stáhnout
----------------------------	----------

WSCAD Universe 2000-436	Stáhnout
-------------------------	----------

Handling Instructions

Jumpered



The push-in type jumper bar system is based on the common plug and socket principle. Each terminal block is spring-loaded with a double socket and a resilient CrNi steel spring. The jumper contact material is pure electrolytic copper, which allows for an extremely small design capable of carrying the full-rated current of the terminal block. Ground terminal blocks can also be commoned using the same jumper system. Custom jumpers are created by breaking and removing jumper contacts (2000, 2001, 2002, 2004 Series).

Removing a push-in type jumper bar.

Insert the operating tool between the jumper and the partition wall of the dual jumper slots, then lift up the jumper.

Place the operating tool in the center of jumpers up to five contacts (see above), or alternately on both sides for jumpers with more than five contacts.

Jumpered



Custom push-in type jumper bars are created by breaking off jumper contacts.



Marking a push-in type jumper bar using a felt-tip pen.

500 V

300 V

Jumpered

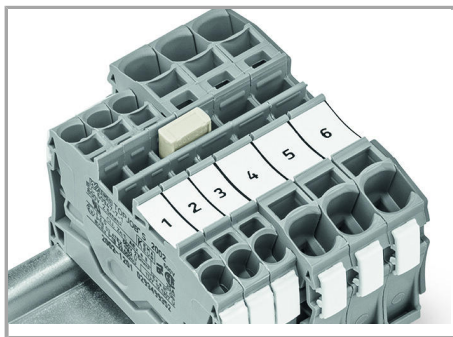

Stepping down via push-in type jumper bar.

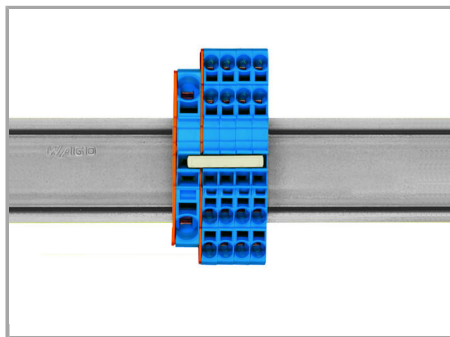

Stepping down via push-in type jumper bar.

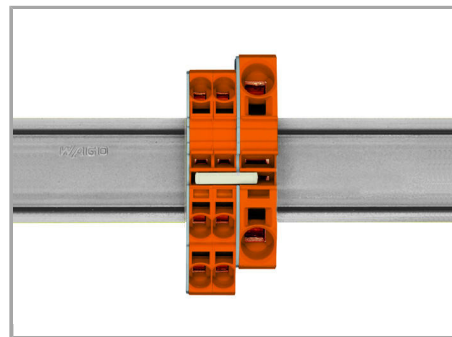

Stepping down via push-in type jumper bar.

Commoning via closed terminal side with end plate allows jumpering over two cross-section sizes, e.g., from 16 mm² (6 AWG) to 6 mm² (10 AWG) or from 6 mm² (10 AWG) to 2.5 mm² (14 AWG) (see illustration above).

Commoning via open terminal side with end plate allows jumpering over two cross-section sizes for 16 mm² (6 AWG) and 10 mm² (8 AWG) and one cross-section size for 6/4/2.5 mm² (10/12/14 AWG). An example: from 16 mm² (6 AWG) to 6 mm² (10 AWG) (see illustration above) or from 10 mm² (8 AWG) to 4 mm² (12 AWG).

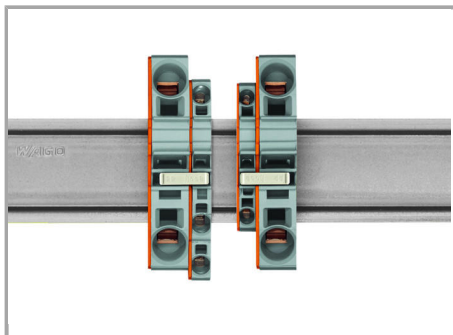

Note:

The total current of the outgoing circuits shall not exceed the nominal current of the step-down jumper/push-in type jumper bar.

Produktová rodina

TOPJOB® S

TOPJOB® S: In various industrial applications and modern building installations, WAGO's wide and versatile range of rail-mount terminal blocks provides more than just reliable electrical connections.

[Zobrazit všechny produkty z rodiny](#)



Změny vyhrazeny.

WAGO Elektro spol. sr. o.
Rozvodova 1116/36
143 00 Praha 12 - Modřany
Tel.: +420 261 090 143
Email: info.cz@wago.com, wago-cz@wago.com

Máte otázky ohledně našich produktů?
Kdykoli nám zavolejte na číslo +420 261 090 143.