

Datový list | Objednací číslo: 769-675/004-000

THT male header; 1.0 x 1.0 mm solder pin; angled; Pin spacing 5 mm; 15-pole; gray

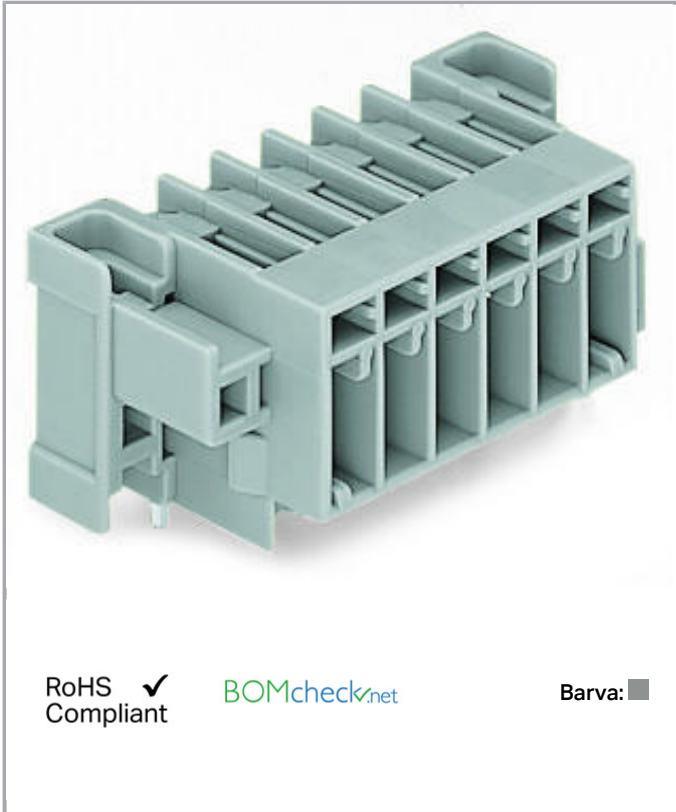

www.wago.com/769-675/004-000



RoHS Compliant

BOMcheck.net

Barva: ■

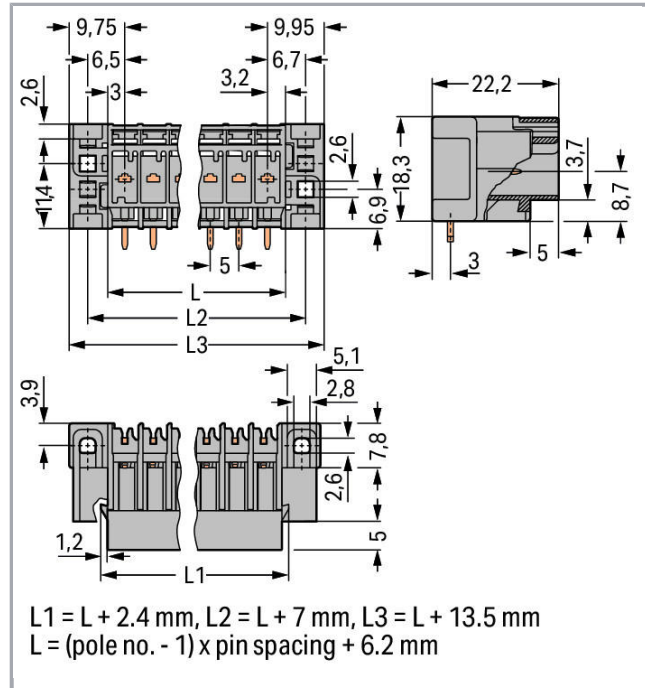

Data

Elektrické parametry

Ratings per IEC/EN 60664-1

Návrhové napětí (III / 3)	250 V
Návrhové rázové napětí (III / 3)	4 kV
Návrhové napětí (III/2)	500 V
Návrhové rázové napětí (III / 2)	4 kV
Jmenovitý proud	32 A
Legenda (návrhové hodnoty)	(III / 3) ≙ kategorie přepětí III / stupeň znečištění 3

Údaje o připojení

Počet pólů	15
Celkový počet potenciálů	15
Počet úrovní	1



Geometrické údaje

Rozteč	5 mm / 0.197 inch
Šířka	89,7 mm / 3.531 inch
Výška od povrchu	18,3 mm / 0.72 inch
Hloubka	22,2 mm / 0.874 inch

Mechanické parametry

Způsob upevnění	Upevňovací příruba
-----------------	--------------------

Plug connection

Typ kontaktu (konektor)	Konektor (vidlice) / zástrčka
Typ připojení konektoru	na desky plošných spojů
Ochrana proti chybnému zapojení	No
Směr zapojení vůči desce plošných spojů	0°

PCB contact

Kontakt na desku plošných spojů	THT
---------------------------------	-----

Údaje o materiálu

barva	Šedá
Izolační materiál	Polyamid 66 (PA 66)
Požární zatížení	0.343 MJ
Hmotnost	16.85 g

Obchodní údaje

Product Group	18 (X-COM-System)
Druh balení	BOX
Country of origin	PL
GTIN	4017332412919
Customs Tariff No.	85366990990

Atesty/certifikáty

Specifické atesty jednotlivých států

Logo	Schválení	Doplňkový text schválení	Název certifikátu
	CCA DEKRA Certification B.V.	EN 60947	NTR NL- 7626
	CCA	EN 61984	2190419.02

DEKRA Certification B.V.



CCA DEKRA Certification B.V.	IEC 61984	NL-47799
---------------------------------	-----------	----------





CSA DEKRA Certification B.V.	C22.2 No. 158	1101144
---------------------------------	---------------	---------



KEMA/KEUR DEKRA Certification B.V.	EN 60947	2190419.01
---------------------------------------	----------	------------

Atesty UL

Logo	Schválení	Doplňkový text schválení	Název certifikátu
	UR Underwriters Laboratories Inc.	UL 1977	E45171-20010720
	UR Underwriters Laboratories Inc.	UL 1059	31.07.2019-E45172

Kompatibilní produkty

















Marking accessories















	Obj. č.: 210-831 Popisovací páska; Na cívce; Šířka 2,3 mm; Bez potisku; Samolepicí; Bílá	www.wago.com/210-831
	Obj. č.: 210-832 Popisovací páska; Na cívce; Šířka 3 mm; Bez potisku; Samolepicí; Bílá	www.wago.com/210-832
	Obj. č.: 210-833 Popisovací páska; Na cívce; Šířka 6 mm; Bez potisku; Samolepicí; Bílá	www.wago.com/210-833
	Obj. č.: 210-834 Popisovací páska; Na cívce; Šířka 5 mm; Bez potisku; Samolepicí; Bílá	www.wago.com/210-834

Coding

	Obj. č.: 769-435 Kódovací kolík; Ke kódování pružinových svorkovnic; Pro základní svorky / konektory s pájecími piny; Oranžová	www.wago.com/769-435
--	---	--

ferrule

	Obj. č.: 216-101 Dutinka; Objímka na 0,5 mm ² / AWG 22; Bez plastového límce; Galvanicky pocínováno	www.wago.com/216-101
	Obj. č.: 216-102 Dutinka; Objímka na 0,75 mm ² / AWG 20; Bez plastového límce; Galvanicky pocínováno	www.wago.com/216-102
	Obj. č.: 216-103 Dutinka; Objímka na 1 mm ² / AWG 18; Bez plastového límce; Galvanicky pocínováno	www.wago.com/216-103
	Obj. č.: 216-104 Dutinka; Objímka na 1,5 mm ² / AWG 16; Bez plastového límce; Galvanicky pocínováno	www.wago.com/216-104
	Obj. č.: 216-201 Ferrule; Sleeve for 0.5 mm ² / 20 AWG; insulated; electro-tin plated; white	www.wago.com/216-201
	Obj. č.: 216-202 Ferrule; Sleeve for 0.75 mm ² / 18 AWG; insulated; electro-tin plated; gray	www.wago.com/216-202
	Obj. č.: 216-203 Dutinka; Objímka na 1 mm ² / AWG 18; S plastovým límcem; Galvanicky pocínováno; Červená	www.wago.com/216-203
	Obj. č.: 216-204 Dutinka; Objímka na 1,5 mm ² / AWG 16; S plastovým límcem; Galvanicky pocínováno; Černá	www.wago.com/216-204
	Obj. č.: 216-206 Dutinka; Objímka na 2,5 mm ² / AWG 14; S plastovým límcem; Galvanicky pocínováno; Modrá	www.wago.com/216-206
	Obj. č.: 216-301 Dutinka; Objímka na 0,25 mm ² / AWG 24; S plastovým límcem; Galvanicky pocínováno; Žlutá	www.wago.com/216-301
	Obj. č.: 216-302 Ferrule; Sleeve for 0.34 mm ² / 22 AWG; insulated; electro-tin plated; green	www.wago.com/216-302
Female plug		
	Obj. č.: 769-101 1 vodičová pružinová svorkovnice; 4 mm ² ; 1pól.; 4,00 mm ² ; Šedá	www.wago.com/769-101
	Obj. č.: 769-102 1 vodičová pružinová svorkovnice; 4 mm ² ; 2pól.; 4,00 mm ² ; Šedá	www.wago.com/769-102
	Obj. č.: 769-102/000-036 1 vodičová pružinová svorkovnice; 4 mm ² ; 2pól.; 4,00 mm ² ; Šedá / zelená – žlutá	www.wago.com/769-102/000-036
	Obj. č.: 769-102/000-037 1 vodičová pružinová svorkovnice; 4 mm ² ; 2pól.; 4,00 mm ² ; Zelená – žlutá / šedá	www.wago.com/769-102/000-037
	Obj. č.: 769-103 1 vodičová pružinová svorkovnice; 4 mm ² ; 3pól.; 4,00 mm ² ; Šedá	www.wago.com/769-103
	Obj. č.: 769-103/000-036 1 vodičová pružinová svorkovnice; 4 mm ² ; 3pól.; 4,00 mm ² ; Šedá / zelená – žlutá	www.wago.com/769-103/000-036
	Obj. č.: 769-103/000-037 1 vodičová pružinová svorkovnice; 4 mm ² ; 3pól.; 4,00 mm ² ; Zelená – žlutá / šedá	www.wago.com/769-103/000-037

	Obj. č.: 769-103/000-038 1 vodičová pružinová svorkovnice; 4 mm ² ; 3pól.; 4,00 mm ² ; Šedá / modrá / zelená – žlutá	www.wago.com/769-103/000-038
	Obj. č.: 769-103/000-039 1 vodičová pružinová svorkovnice; 4 mm ² ; 3pól.; 4,00 mm ² ; Zelená – žlutá, modrá, šedá	www.wago.com/769-103/000-039
	Obj. č.: 769-104 1 vodičová pružinová svorkovnice; 4 mm ² ; 4pól.; 4,00 mm ² ; Šedá	www.wago.com/769-104
	Obj. č.: 769-104/000-036 1 vodičová pružinová svorkovnice; 4 mm ² ; 4pól.; 4,00 mm ² ; Šedá / zelená – žlutá	www.wago.com/769-104/000-036
	Obj. č.: 769-104/000-037 1 vodičová pružinová svorkovnice; 4 mm ² ; 4pól.; 4,00 mm ² ; Zelená – žlutá / šedá	www.wago.com/769-104/000-037
	Obj. č.: 769-104/000-038 1 vodičová pružinová svorkovnice; 4 mm ² ; 4pól.; 4,00 mm ² ; Šedá / modrá / zelená – žlutá	www.wago.com/769-104/000-038
	Obj. č.: 769-104/000-039 1 vodičová pružinová svorkovnice; 4 mm ² ; 4pól.; 4,00 mm ² ; Zelená – žlutá, modrá, šedá	www.wago.com/769-104/000-039
	Obj. č.: 769-105 1 vodičová pružinová svorkovnice; 4 mm ² ; 5pól.; 4,00 mm ² ; Šedá	www.wago.com/769-105
	Obj. č.: 769-105/000-036 1 vodičová pružinová svorkovnice; 4 mm ² ; 5pól.; 4,00 mm ² ; Šedá / zelená – žlutá	www.wago.com/769-105/000-036
	Obj. č.: 769-105/000-037 1 vodičová pružinová svorkovnice; 4 mm ² ; 5pól.; 4,00 mm ² ; Zelená – žlutá / šedá	www.wago.com/769-105/000-037
	Obj. č.: 769-105/000-038 1 vodičová pružinová svorkovnice; 4 mm ² ; 5pól.; 4,00 mm ² ; Šedá / modrá / zelená – žlutá	www.wago.com/769-105/000-038
	Obj. č.: 769-105/000-039 1 vodičová pružinová svorkovnice; 4 mm ² ; 5pól.; 4,00 mm ² ; Zelená – žlutá, modrá, šedá	www.wago.com/769-105/000-039
	Obj. č.: 769-106 1 vodičová pružinová svorkovnice; 4 mm ² ; 6pól.; 4,00 mm ² ; Šedá	www.wago.com/769-106
	Obj. č.: 769-106/000-006 1 vodičová pružinová svorkovnice; 4 mm ² ; 6pól.; 4,00 mm ² ; Modrá	www.wago.com/769-106/000-006
	Obj. č.: 769-106/000-036 1 vodičová pružinová svorkovnice; 4 mm ² ; 6pól.; 4,00 mm ² ; Šedá / zelená – žlutá	www.wago.com/769-106/000-036
	Obj. č.: 769-106/000-037 1 vodičová pružinová svorkovnice; 4 mm ² ; 6pól.; 4,00 mm ² ; Zelená – žlutá / šedá	www.wago.com/769-106/000-037



Obj. č.: 769-106/000-038
1 vodičová pružinová svorkovnice; 4 mm²; 6pól.; 4,00 mm²; Šedá / modrá / zelená – žlutá

www.wago.com/769-106/000-038



Obj. č.: 769-106/000-039
1 vodičová pružinová svorkovnice; 4 mm²; 6pól.; 4,00 mm²; Zelená – žlutá, modrá, šedá

www.wago.com/769-106/000-039



Obj. č.: 769-107
1 vodičová pružinová svorkovnice; 4 mm²; 7pól.; 4,00 mm²; Šedá

www.wago.com/769-107



Obj. č.: 769-107/000-036
1 vodičová pružinová svorkovnice; 4 mm²; 7pól.; 4,00 mm²; Šedá / zelená – žlutá

www.wago.com/769-107/000-036



Obj. č.: 769-107/000-037
1 vodičová pružinová svorkovnice; 4 mm²; 7pól.; 4,00 mm²; Zelená – žlutá / šedá

www.wago.com/769-107/000-037



Obj. č.: 769-107/000-038
1 vodičová pružinová svorkovnice; 4 mm²; 7pól.; 4,00 mm²; Šedá / modrá / zelená – žlutá

www.wago.com/769-107/000-038



Obj. č.: 769-107/000-039
1 vodičová pružinová svorkovnice; 4 mm²; 7pól.; 4,00 mm²; Zelená – žlutá, modrá, šedá

www.wago.com/769-107/000-039



Obj. č.: 769-108
1 vodičová pružinová svorkovnice; 4 mm²; 8pól.; 4,00 mm²; Šedá

www.wago.com/769-108



Obj. č.: 769-108/000-036
1 vodičová pružinová svorkovnice; 4 mm²; 8pól.; 4,00 mm²; Šedá / zelená – žlutá

www.wago.com/769-108/000-036



Obj. č.: 769-108/000-037
1 vodičová pružinová svorkovnice; 4 mm²; 8pól.; 4,00 mm²; Zelená – žlutá / šedá

www.wago.com/769-108/000-037



Obj. č.: 769-108/000-038
1 vodičová pružinová svorkovnice; 4 mm²; 8pól.; 4,00 mm²; Šedá / modrá / zelená – žlutá

www.wago.com/769-108/000-038



Obj. č.: 769-108/000-039
1 vodičová pružinová svorkovnice; 4 mm²; 8pól.; 4,00 mm²; Zelená – žlutá, modrá, šedá

www.wago.com/769-108/000-039



Obj. č.: 769-109
1 vodičová pružinová svorkovnice; 4 mm²; 9pól.; 4,00 mm²; Šedá

www.wago.com/769-109

















Obj. č.: 769-109/000-036
1 vodičová pružinová svorkovnice; 4 mm²; 9pól.; 4,00 mm²; Šedá / zelená – žlutá

www.wago.com/769-109/000-036



Obj. č.: 769-109/000-037
1 vodičová pružinová svorkovnice; 4 mm²; 9pól.; 4,00 mm²; Zelená – žlutá / šedá

www.wago.com/769-109/000-037

	Obj. č.: 769-109/000-038 1 vodičová pružinová svorkovnice; 4 mm ² ; 9pól.; 4,00 mm ² ; Šedá / modrá / zelená – žlutá	www.wago.com/769-109/000-038
	Obj. č.: 769-109/000-039 1 vodičová pružinová svorkovnice; 4 mm ² ; 9pól.; 4,00 mm ² ; Zelená – žlutá, modrá, šedá	www.wago.com/769-109/000-039
	Obj. č.: 769-110 1 vodičová pružinová svorkovnice; 4 mm ² ; 10pól.; 4,00 mm ² ; Šedá	www.wago.com/769-110
	Obj. č.: 769-110/000-036 1 vodičová pružinová svorkovnice; 4 mm ² ; 10pól.; 4,00 mm ² ; Šedá / zelená – žlutá	www.wago.com/769-110/000-036
	Obj. č.: 769-110/000-037 1 vodičová pružinová svorkovnice; 4 mm ² ; 10pól.; 4,00 mm ² ; Zelená – žlutá / šedá	www.wago.com/769-110/000-037
	Obj. č.: 769-110/000-038 1 vodičová pružinová svorkovnice; 4 mm ² ; 10pól.; 4,00 mm ² ; Šedá / modrá / zelená – žlutá	www.wago.com/769-110/000-038
	Obj. č.: 769-110/000-039 1 vodičová pružinová svorkovnice; 4 mm ² ; 10pól.; 4,00 mm ² ; Zelená – žlutá, modrá, šedá	www.wago.com/769-110/000-039
	Obj. č.: 769-111 1 vodičová pružinová svorkovnice; 4 mm ² ; 11pól.; 4,00 mm ² ; Šedá	www.wago.com/769-111
	Obj. č.: 769-111/000-036 1 vodičová pružinová svorkovnice; 4 mm ² ; 11pól.; 4,00 mm ² ; Šedá / zelená – žlutá	www.wago.com/769-111/000-036
	Obj. č.: 769-111/000-037 1 vodičová pružinová svorkovnice; 4 mm ² ; 11pól.; 4,00 mm ² ; Zelená – žlutá / šedá	www.wago.com/769-111/000-037
	Obj. č.: 769-111/000-038 1 vodičová pružinová svorkovnice; 4 mm ² ; 11pól.; 4,00 mm ² ; Šedá / modrá / zelená – žlutá	www.wago.com/769-111/000-038
	Obj. č.: 769-111/000-039 1 vodičová pružinová svorkovnice; 4 mm ² ; 11pól.; 4,00 mm ² ; Zelená – žlutá, modrá, šedá	www.wago.com/769-111/000-039
	Obj. č.: 769-112 1 vodičová pružinová svorkovnice; 4 mm ² ; 12pól.; 4,00 mm ² ; Šedá	www.wago.com/769-112
	Obj. č.: 769-112/000-036 1 vodičová pružinová svorkovnice; 4 mm ² ; 12pól.; 4,00 mm ² ; Šedá / zelená – žlutá	www.wago.com/769-112/000-036
	Obj. č.: 769-112/000-037 1 vodičová pružinová svorkovnice; 4 mm ² ; 12pól.; 4,00 mm ² ; Zelená – žlutá / šedá	www.wago.com/769-112/000-037



Obj. č.: 769-112/000-038
1 vodičová pružinová svorkovnice; 4 mm²; 12pól.; 4,00 mm²; Šedá / modrá / zelená – žlutá

www.wago.com/769-112/000-038



Obj. č.: 769-112/000-039
1 vodičová pružinová svorkovnice; 4 mm²; 12pól.; 4,00 mm²; Zelená – žlutá, modrá, šedá

www.wago.com/769-112/000-039



Obj. č.: 769-113
1 vodičová pružinová svorkovnice; 4 mm²; 13pól.; 4,00 mm²; Šedá

www.wago.com/769-113



Obj. č.: 769-113/000-036
1 vodičová pružinová svorkovnice; 4 mm²; 13pól.; 4,00 mm²; Šedá / zelená – žlutá

www.wago.com/769-113/000-036



Obj. č.: 769-113/000-037
1 vodičová pružinová svorkovnice; 4 mm²; 13pól.; 4,00 mm²; Zelená – žlutá / šedá

www.wago.com/769-113/000-037



Obj. č.: 769-113/000-038
1 vodičová pružinová svorkovnice; 4 mm²; 13pól.; 4,00 mm²; Šedá / modrá / zelená – žlutá

www.wago.com/769-113/000-038



Obj. č.: 769-113/000-039
1 vodičová pružinová svorkovnice; 4 mm²; 13pól.; 4,00 mm²; Zelená – žlutá, modrá, šedá

www.wago.com/769-113/000-039



Obj. č.: 769-114
1 vodičová pružinová svorkovnice; 4 mm²; 14pól.; 4,00 mm²; Šedá

www.wago.com/769-114



Obj. č.: 769-114/000-036
1 vodičová pružinová svorkovnice; 4 mm²; 14pól.; 4,00 mm²; Šedá / zelená – žlutá

www.wago.com/769-114/000-036



Obj. č.: 769-114/000-037
1 vodičová pružinová svorkovnice; 4 mm²; 14pól.; 4,00 mm²; Zelená – žlutá / šedá

www.wago.com/769-114/000-037



Obj. č.: 769-114/000-038
1 vodičová pružinová svorkovnice; 4 mm²; 14pól.; 4,00 mm²; Šedá / modrá / zelená – žlutá

www.wago.com/769-114/000-038



Obj. č.: 769-114/000-039
1 vodičová pružinová svorkovnice; 4 mm²; 14pól.; 4,00 mm²; Zelená – žlutá, modrá, šedá

www.wago.com/769-114/000-039



Obj. č.: 769-115/000-036
1 vodičová pružinová svorkovnice; 4 mm²; 15pól.; 4,00 mm²; Šedá / zelená – žlutá

www.wago.com/769-115/000-036

















Obj. č.: 769-115/000-037
1 vodičová pružinová svorkovnice; 4 mm²; 15pól.; 4,00 mm²; Zelená – žlutá / šedá

www.wago.com/769-115/000-037



Obj. č.: 769-115/000-038
1 vodičová pružinová svorkovnice; 4 mm²; 15pól.; 4,00 mm²; Šedá / modrá / zelená – žlutá

www.wago.com/769-115/000-038

	<p>Obj. č.: 769-115/000-039 1 vodičová pružinová svorkovnice; 4 mm²; 15pól.; 4,00 mm²; Zelená – žlutá, modrá, šedá</p>	www.wago.com/769-115/000-039
	<p>Obj. č.: 769-121 2 vodičová pružinová svorkovnice; 4 mm²; 1pól.; 4,00 mm²; Šedá</p>	www.wago.com/769-121
	<p>Obj. č.: 769-122 2 vodičová pružinová svorkovnice; 4 mm²; 2pól.; 4,00 mm²; Šedá</p>	www.wago.com/769-122
	<p>Obj. č.: 769-123 2 vodičová pružinová svorkovnice; 4 mm²; 3pól.; 4,00 mm²; Šedá</p>	www.wago.com/769-123
	<p>Obj. č.: 769-124 2 vodičová pružinová svorkovnice; 4 mm²; 4pól.; 4,00 mm²; Šedá</p>	www.wago.com/769-124
	<p>Obj. č.: 769-125 2 vodičová pružinová svorkovnice; 4 mm²; 5pól.; 4,00 mm²; Šedá</p>	www.wago.com/769-125
	<p>Obj. č.: 769-126 2 vodičová pružinová svorkovnice; 4 mm²; 6pól.; 4,00 mm²; Šedá</p>	www.wago.com/769-126
	<p>Obj. č.: 769-127 2 vodičová pružinová svorkovnice; 4 mm²; 7pól.; 4,00 mm²; Šedá</p>	www.wago.com/769-127
	<p>Obj. č.: 769-128 2 vodičová pružinová svorkovnice; 4 mm²; 8pól.; 4,00 mm²; Šedá</p>	www.wago.com/769-128
	<p>Obj. č.: 769-129 2 vodičová pružinová svorkovnice; 4 mm²; 9pól.; 4,00 mm²; Šedá</p>	www.wago.com/769-129
	<p>Obj. č.: 769-130 2 vodičová pružinová svorkovnice; 4 mm²; 10pól.; 4,00 mm²; Šedá</p>	www.wago.com/769-130
	<p>Obj. č.: 769-131 2 vodičová pružinová svorkovnice; 4 mm²; 11pól.; 4,00 mm²; Šedá</p>	www.wago.com/769-131
	<p>Obj. č.: 769-132 2 vodičová pružinová svorkovnice; 4 mm²; 12pól.; 4,00 mm²; Šedá</p>	www.wago.com/769-132
	<p>Obj. č.: 769-133 2 vodičová pružinová svorkovnice; 4 mm²; 13pól.; 4,00 mm²; Šedá</p>	www.wago.com/769-133
	<p>Obj. č.: 769-134 2 vodičová pružinová svorkovnice; 4 mm²; 14pól.; 4,00 mm²; Šedá</p>	www.wago.com/769-134

Ke stažení

Documentation

Additional Information

Technical explanations	03-Apr-2019	pdf 2,1 MB	Stáhnout
------------------------	-------------	---------------	----------

CAD/CAE-Data

CAD data



2D/3D Models 769-675/004-000

URL

Stáhnout

Handling Instructions

Produktová rodina

X-COM

[Zobrazit všechny produkty z rodiny](#)

Změny vyhrazeny.

WAGO Elektro spol. sr. o.
Rozvodova 1116/36
143 00 Praha 12 - Modřany
Tel.: +420 261 090 143

Email: info.cz@wago.com, wago-cz@wago.com

Máte otázky ohledně našich produktů?

Kdykoli nám zavolejte na číslo +420 261 090 143.