

Datový list | Objednací číslo: 769-669

Konektor s pájecími piny THT; 1.0 x 1.0 mm solder pin; Úhlové provedení;
Rozteč 5 mm; 9pól.; Šedá



www.wago.com/769-669



RoHS Compliant

[BOMcheck.net](https://www.bomcheck.net)

Barva: ■

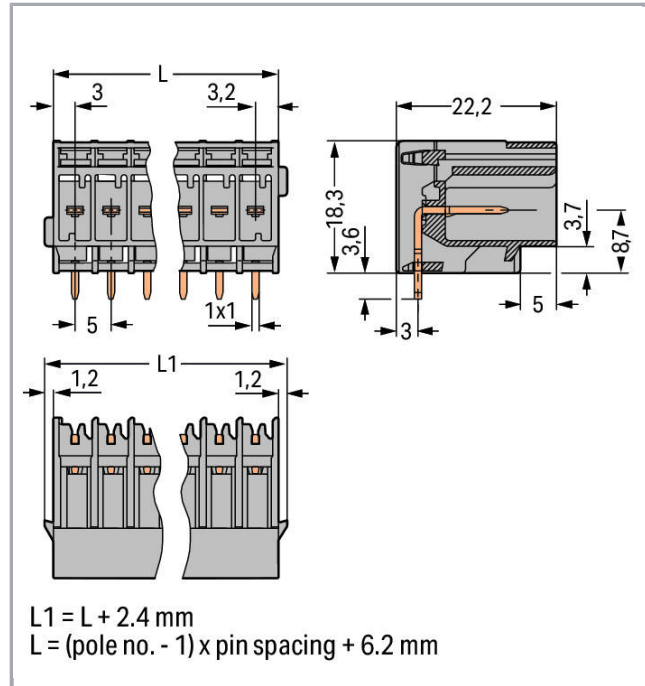

Data

Elektrické parametry

Ratings per IEC/EN 60664-1

Návrhové napětí (III / 3)	250 V
Návrhové rázové napětí (III / 3)	4 kV
Návrhové napětí (III/2)	500 V
Návrhové rázové napětí (III / 2)	4 kV
Jmenovitý proud	32 A
Legenda (návrhové hodnoty)	(III / 3) ≙ kategorie přepětí III / stupeň znečištění 3

Údaje o připojení

Počet pólů	9
Celkový počet potenciálů	9
Počet úrovní	1

Geometrické údaje

Rozteč	5 mm / 0.197 inch
Šířka	48,6 mm / 1.913 inch
Výška od povrchu	18,3 mm / 0.72 inch
Hloubka	22,2 mm / 0.874 inch

Plug connection

Typ kontaktu (konektor)	Konektor (vidlice) / zástrčka
Typ připojení konektoru	na desky plošných spojů
Ochrana proti chybnému zapojení	No
Směr zapojení vůči desce plošných spojů	0°

PCB contact

Kontakt na desku plošných spojů	THT
---------------------------------	-----

Údaje o materiálu



barva	Šedá
Izolační materiál	Polyamid 66 (PA 66)
Požární zatížení	0.195 MJ
Hmotnost	9.758 g

Obchodní údaje

Product Group	18 (X-COM-System)
Druh balení	BOX
Country of origin	DE
GTIN	4044918760515
Customs Tariff No.	85366990990

Atesty/certifikáty

Specifické atesty jednotlivých států

Logo	Schválení	Doplňkový text schválení	Název certifikátu
	CCA DEKRA Certification B.V.	EN 60947	NTR NL-7626
	CCA DEKRA Certification B.V.	EN 61984	2190419.02
	CCA	IEC 61984	NL-47799

DEKRA Certification B.V.

CSA
DEKRA Certification B.V.

C22.2 No. 158



1101144

KEMA/KEUR
DEKRA Certification B.V.

EN 60947









2190419.01















Atesty UL















Logo	Schválení	Doplňkový text schválení	Název certifikátu
	UR Underwriters Laboratories Inc.	UL 1977	E45171- 20010720
	UR Underwriters Laboratories Inc.	UL 1059	31.07.2019- E45172















Kompatibilní produkty















ferrule

	Obj. č.: 216-101 Dutinka; Objímka na 0,5 mm ² / AWG 22; Bez plastového límce; Galvanicky pocínováno	www.wago.com/216-101
	Obj. č.: 216-102 Dutinka; Objímka na 0,75 mm ² / AWG 20; Bez plastového límce; Galvanicky pocínováno	www.wago.com/216-102
	Obj. č.: 216-103 Dutinka; Objímka na 1 mm ² / AWG 18; Bez plastového límce; Galvanicky pocínováno	www.wago.com/216-103
	Obj. č.: 216-104 Dutinka; Objímka na 1,5 mm ² / AWG 16; Bez plastového límce; Galvanicky pocínováno	www.wago.com/216-104
	Obj. č.: 216-201 Ferrule; Sleeve for 0.5 mm ² / 20 AWG; insulated; electro-tin plated; white	www.wago.com/216-201
	Obj. č.: 216-202 Ferrule; Sleeve for 0.75 mm ² / 18 AWG; insulated; electro-tin plated; gray	www.wago.com/216-202
	Obj. č.: 216-203 Dutinka; Objímka na 1 mm ² / AWG 18; S plastovým límcem; Galvanicky pocínováno; Červená	www.wago.com/216-203
	Obj. č.: 216-204 Dutinka; Objímka na 1,5 mm ² / AWG 16; S plastovým límcem; Galvanicky pocínováno; Černá	www.wago.com/216-204













	Obj. č.: 216-206 Dutinka; Objímka na 2,5 mm ² / AWG 14; S plastovým límcem; Galvanicky pocínováno; Modrá	www.wago.com/216-206
	Obj. č.: 216-301 Dutinka; Objímka na 0,25 mm ² / AWG 24; S plastovým límcem; Galvanicky pocínováno; Žlutá	www.wago.com/216-301
	Obj. č.: 216-302 Ferrule; Sleeve for 0.34 mm ² / 22 AWG; insulated; electro-tin plated; green	www.wago.com/216-302
Marking accessories		
	Obj. č.: 210-831 Popisovací páska; Na cívice; Šířka 2,3 mm; Bez potisku; Samolepicí; Bílá	www.wago.com/210-831
	Obj. č.: 210-832 Popisovací páska; Na cívice; Šířka 3 mm; Bez potisku; Samolepicí; Bílá	www.wago.com/210-832
	Obj. č.: 210-833 Popisovací páska; Na cívice; Šířka 6 mm; Bez potisku; Samolepicí; Bílá	www.wago.com/210-833
	Obj. č.: 210-834 Popisovací páska; Na cívice; Šířka 5 mm; Bez potisku; Samolepicí; Bílá	www.wago.com/210-834
Coding		
	Obj. č.: 769-435 Kódovací kolík; Ke kódování pružinových svorkovnic; Pro základní svorky / konektory s pájecími piny; Oranžová	www.wago.com/769-435
Female plug		
	Obj. č.: 769-101 1 vodičová pružinová svorkovnice; 4 mm ² ; 1pól.; 4,00 mm ² ; Šedá	www.wago.com/769-101
	Obj. č.: 769-102 1 vodičová pružinová svorkovnice; 4 mm ² ; 2pól.; 4,00 mm ² ; Šedá	www.wago.com/769-102
	Obj. č.: 769-102/000-036 1 vodičová pružinová svorkovnice; 4 mm ² ; 2pól.; 4,00 mm ² ; Šedá / zelená – žlutá	www.wago.com/769-102/000-036
	Obj. č.: 769-102/000-037 1 vodičová pružinová svorkovnice; 4 mm ² ; 2pól.; 4,00 mm ² ; Zelená – žlutá / šedá	www.wago.com/769-102/000-037
	Obj. č.: 769-103 1 vodičová pružinová svorkovnice; 4 mm ² ; 3pól.; 4,00 mm ² ; Šedá	www.wago.com/769-103
	Obj. č.: 769-103/000-036 1 vodičová pružinová svorkovnice; 4 mm ² ; 3pól.; 4,00 mm ² ; Šedá / zelená – žlutá	www.wago.com/769-103/000-036
	Obj. č.: 769-103/000-037 1 vodičová pružinová svorkovnice; 4 mm ² ; 3pól.; 4,00 mm ² ; Zelená – žlutá / šedá	www.wago.com/769-103/000-037
	Obj. č.: 769-103/000-038 1 vodičová pružinová svorkovnice; 4 mm ² ; 3pól.; 4,00 mm ² ; Šedá / modrá / zelená – žlutá	www.wago.com/769-103/000-038

	Obj. č.: 769-103/000-039 1 vodičová pružinová svorkovnice; 4 mm ² ; 3pól.; 4,00 mm ² ; Zelená – žlutá, modrá, šedá	www.wago.com/769-103/000-039
	Obj. č.: 769-104 1 vodičová pružinová svorkovnice; 4 mm ² ; 4pól.; 4,00 mm ² ; Šedá	www.wago.com/769-104
	Obj. č.: 769-104/000-036 1 vodičová pružinová svorkovnice; 4 mm ² ; 4pól.; 4,00 mm ² ; Šedá / zelená – žlutá	www.wago.com/769-104/000-036
	Obj. č.: 769-104/000-037 1 vodičová pružinová svorkovnice; 4 mm ² ; 4pól.; 4,00 mm ² ; Zelená – žlutá / šedá	www.wago.com/769-104/000-037
	Obj. č.: 769-104/000-038 1 vodičová pružinová svorkovnice; 4 mm ² ; 4pól.; 4,00 mm ² ; Šedá / modrá / zelená – žlutá	www.wago.com/769-104/000-038
	Obj. č.: 769-104/000-039 1 vodičová pružinová svorkovnice; 4 mm ² ; 4pól.; 4,00 mm ² ; Zelená – žlutá, modrá, šedá	www.wago.com/769-104/000-039
	Obj. č.: 769-105 1 vodičová pružinová svorkovnice; 4 mm ² ; 5pól.; 4,00 mm ² ; Šedá	www.wago.com/769-105
	Obj. č.: 769-105/000-036 1 vodičová pružinová svorkovnice; 4 mm ² ; 5pól.; 4,00 mm ² ; Šedá / zelená – žlutá	www.wago.com/769-105/000-036
	Obj. č.: 769-105/000-037 1 vodičová pružinová svorkovnice; 4 mm ² ; 5pól.; 4,00 mm ² ; Zelená – žlutá / šedá	www.wago.com/769-105/000-037
	Obj. č.: 769-105/000-038 1 vodičová pružinová svorkovnice; 4 mm ² ; 5pól.; 4,00 mm ² ; Šedá / modrá / zelená – žlutá	www.wago.com/769-105/000-038
	Obj. č.: 769-105/000-039 1 vodičová pružinová svorkovnice; 4 mm ² ; 5pól.; 4,00 mm ² ; Zelená – žlutá, modrá, šedá	www.wago.com/769-105/000-039
	Obj. č.: 769-106 1 vodičová pružinová svorkovnice; 4 mm ² ; 6pól.; 4,00 mm ² ; Šedá	www.wago.com/769-106
	Obj. č.: 769-106/000-006 1 vodičová pružinová svorkovnice; 4 mm ² ; 6pól.; 4,00 mm ² ; Modrá	www.wago.com/769-106/000-006
	Obj. č.: 769-106/000-036 1 vodičová pružinová svorkovnice; 4 mm ² ; 6pól.; 4,00 mm ² ; Šedá / zelená – žlutá	www.wago.com/769-106/000-036
	Obj. č.: 769-106/000-037 1 vodičová pružinová svorkovnice; 4 mm ² ; 6pól.; 4,00 mm ² ; Zelená – žlutá / šedá	www.wago.com/769-106/000-037

	Obj. č.: 769-106/000-038 1 vodičová pružinová svorkovnice; 4 mm ² ; 6pól.; 4,00 mm ² ; Šedá / modrá / zelená – žlutá	www.wago.com/769-106/000-038
	Obj. č.: 769-106/000-039 1 vodičová pružinová svorkovnice; 4 mm ² ; 6pól.; 4,00 mm ² ; Zelená – žlutá, modrá, šedá	www.wago.com/769-106/000-039
	Obj. č.: 769-107 1 vodičová pružinová svorkovnice; 4 mm ² ; 7pól.; 4,00 mm ² ; Šedá	www.wago.com/769-107
	Obj. č.: 769-107/000-036 1 vodičová pružinová svorkovnice; 4 mm ² ; 7pól.; 4,00 mm ² ; Šedá / zelená – žlutá	www.wago.com/769-107/000-036
	Obj. č.: 769-107/000-037 1 vodičová pružinová svorkovnice; 4 mm ² ; 7pól.; 4,00 mm ² ; Zelená – žlutá / šedá	www.wago.com/769-107/000-037
	Obj. č.: 769-107/000-038 1 vodičová pružinová svorkovnice; 4 mm ² ; 7pól.; 4,00 mm ² ; Šedá / modrá / zelená – žlutá	www.wago.com/769-107/000-038
	Obj. č.: 769-107/000-039 1 vodičová pružinová svorkovnice; 4 mm ² ; 7pól.; 4,00 mm ² ; Zelená – žlutá, modrá, šedá	www.wago.com/769-107/000-039
	Obj. č.: 769-108 1 vodičová pružinová svorkovnice; 4 mm ² ; 8pól.; 4,00 mm ² ; Šedá	www.wago.com/769-108
	Obj. č.: 769-108/000-036 1 vodičová pružinová svorkovnice; 4 mm ² ; 8pól.; 4,00 mm ² ; Šedá / zelená – žlutá	www.wago.com/769-108/000-036
	Obj. č.: 769-108/000-037 1 vodičová pružinová svorkovnice; 4 mm ² ; 8pól.; 4,00 mm ² ; Zelená – žlutá / šedá	www.wago.com/769-108/000-037
	Obj. č.: 769-108/000-038 1 vodičová pružinová svorkovnice; 4 mm ² ; 8pól.; 4,00 mm ² ; Šedá / modrá / zelená – žlutá	www.wago.com/769-108/000-038
	Obj. č.: 769-108/000-039 1 vodičová pružinová svorkovnice; 4 mm ² ; 8pól.; 4,00 mm ² ; Zelená – žlutá, modrá, šedá	www.wago.com/769-108/000-039
	Obj. č.: 769-109/000-036 1 vodičová pružinová svorkovnice; 4 mm ² ; 9pól.; 4,00 mm ² ; Šedá / zelená – žlutá	www.wago.com/769-109/000-036
	Obj. č.: 769-109/000-037 1 vodičová pružinová svorkovnice; 4 mm ² ; 9pól.; 4,00 mm ² ; Zelená – žlutá / šedá	www.wago.com/769-109/000-037
	Obj. č.: 769-109/000-038 1 vodičová pružinová svorkovnice; 4 mm ² ; 9pól.; 4,00 mm ² ; Šedá / modrá / zelená – žlutá	www.wago.com/769-109/000-038

	Obj. č.: 769-109/000-039 1 vodičová pružinová svorkovnice; 4 mm ² ; 9pól.; 4,00 mm ² ; Zelená – žlutá, modrá, šedá	www.wago.com/769-109/000-039
	Obj. č.: 769-110 1 vodičová pružinová svorkovnice; 4 mm ² ; 10pól.; 4,00 mm ² ; Šedá	www.wago.com/769-110
	Obj. č.: 769-110/000-036 1 vodičová pružinová svorkovnice; 4 mm ² ; 10pól.; 4,00 mm ² ; Šedá / zelená – žlutá	www.wago.com/769-110/000-036
	Obj. č.: 769-110/000-037 1 vodičová pružinová svorkovnice; 4 mm ² ; 10pól.; 4,00 mm ² ; Zelená – žlutá / šedá	www.wago.com/769-110/000-037
	Obj. č.: 769-110/000-038 1 vodičová pružinová svorkovnice; 4 mm ² ; 10pól.; 4,00 mm ² ; Šedá / modrá / zelená – žlutá	www.wago.com/769-110/000-038
	Obj. č.: 769-110/000-039 1 vodičová pružinová svorkovnice; 4 mm ² ; 10pól.; 4,00 mm ² ; Zelená – žlutá, modrá, šedá	www.wago.com/769-110/000-039
	Obj. č.: 769-111 1 vodičová pružinová svorkovnice; 4 mm ² ; 11pól.; 4,00 mm ² ; Šedá	www.wago.com/769-111
	Obj. č.: 769-111/000-036 1 vodičová pružinová svorkovnice; 4 mm ² ; 11pól.; 4,00 mm ² ; Šedá / zelená – žlutá	www.wago.com/769-111/000-036
	Obj. č.: 769-111/000-037 1 vodičová pružinová svorkovnice; 4 mm ² ; 11pól.; 4,00 mm ² ; Zelená – žlutá / šedá	www.wago.com/769-111/000-037
	Obj. č.: 769-111/000-038 1 vodičová pružinová svorkovnice; 4 mm ² ; 11pól.; 4,00 mm ² ; Šedá / modrá / zelená – žlutá	www.wago.com/769-111/000-038
	Obj. č.: 769-111/000-039 1 vodičová pružinová svorkovnice; 4 mm ² ; 11pól.; 4,00 mm ² ; Zelená – žlutá, modrá, šedá	www.wago.com/769-111/000-039
	Obj. č.: 769-112 1 vodičová pružinová svorkovnice; 4 mm ² ; 12pól.; 4,00 mm ² ; Šedá	www.wago.com/769-112
	Obj. č.: 769-112/000-036 1 vodičová pružinová svorkovnice; 4 mm ² ; 12pól.; 4,00 mm ² ; Šedá / zelená – žlutá	www.wago.com/769-112/000-036
	Obj. č.: 769-112/000-037 1 vodičová pružinová svorkovnice; 4 mm ² ; 12pól.; 4,00 mm ² ; Zelená – žlutá / šedá	www.wago.com/769-112/000-037
	Obj. č.: 769-112/000-038 1 vodičová pružinová svorkovnice; 4 mm ² ; 12pól.; 4,00 mm ² ; Šedá / modrá / zelená – žlutá	www.wago.com/769-112/000-038
	Obj. č.: 769-112/000-039 1 vodičová pružinová svorkovnice; 4 mm ² ; 12pól.; 4,00 mm ² ; Zelená – žlutá, modrá, šedá	www.wago.com/769-112/000-039

**Obj. č.: 769-113**1 vodičová pružinová svorkovnice; 4 mm²; 13pól.; 4,00 mm²; Šedáwww.wago.com/769-113**Obj. č.: 769-113/000-036**1 vodičová pružinová svorkovnice; 4 mm²; 13pól.; 4,00 mm²; Šedá / zelená – žlutáwww.wago.com/769-113/000-036**Obj. č.: 769-113/000-037**1 vodičová pružinová svorkovnice; 4 mm²; 13pól.; 4,00 mm²; Zelená – žlutá / šedáwww.wago.com/769-113/000-037**Obj. č.: 769-113/000-038**1 vodičová pružinová svorkovnice; 4 mm²; 13pól.; 4,00 mm²; Šedá / modrá / zelená – žlutáwww.wago.com/769-113/000-038**Obj. č.: 769-113/000-039**1 vodičová pružinová svorkovnice; 4 mm²; 13pól.; 4,00 mm²; Zelená – žlutá, modrá, šedáwww.wago.com/769-113/000-039**Obj. č.: 769-114**1 vodičová pružinová svorkovnice; 4 mm²; 14pól.; 4,00 mm²; Šedáwww.wago.com/769-114**Obj. č.: 769-114/000-036**1 vodičová pružinová svorkovnice; 4 mm²; 14pól.; 4,00 mm²; Šedá / zelená – žlutáwww.wago.com/769-114/000-036**Obj. č.: 769-114/000-037**1 vodičová pružinová svorkovnice; 4 mm²; 14pól.; 4,00 mm²; Zelená – žlutá / šedáwww.wago.com/769-114/000-037**Obj. č.: 769-114/000-038**1 vodičová pružinová svorkovnice; 4 mm²; 14pól.; 4,00 mm²; Šedá / modrá / zelená – žlutáwww.wago.com/769-114/000-038**Obj. č.: 769-114/000-039**1 vodičová pružinová svorkovnice; 4 mm²; 14pól.; 4,00 mm²; Zelená – žlutá, modrá, šedáwww.wago.com/769-114/000-039**Obj. č.: 769-115**1 vodičová pružinová svorkovnice; 4 mm²; 15pól.; 4,00 mm²; Šedáwww.wago.com/769-115**Obj. č.: 769-115/000-036**1 vodičová pružinová svorkovnice; 4 mm²; 15pól.; 4,00 mm²; Šedá / zelená – žlutáwww.wago.com/769-115/000-036**Obj. č.: 769-115/000-037**1 vodičová pružinová svorkovnice; 4 mm²; 15pól.; 4,00 mm²; Zelená – žlutá / šedáwww.wago.com/769-115/000-037**Obj. č.: 769-115/000-038**1 vodičová pružinová svorkovnice; 4 mm²; 15pól.; 4,00 mm²; Šedá / modrá / zelená – žlutáwww.wago.com/769-115/000-038**Obj. č.: 769-115/000-039**1 vodičová pružinová svorkovnice; 4 mm²; 15pól.; 4,00 mm²; Zelená – žlutá, modrá, šedáwww.wago.com/769-115/000-039

	Obj. č.: 769-122 2vodičová pružinová svorkovnice; 4 mm ² ; 2pól.; 4,00 mm ² ; Šedá	www.wago.com/769-122
	Obj. č.: 769-123 2vodičová pružinová svorkovnice; 4 mm ² ; 3pól.; 4,00 mm ² ; Šedá	www.wago.com/769-123
	Obj. č.: 769-124 2vodičová pružinová svorkovnice; 4 mm ² ; 4pól.; 4,00 mm ² ; Šedá	www.wago.com/769-124
	Obj. č.: 769-125 2vodičová pružinová svorkovnice; 4 mm ² ; 5pól.; 4,00 mm ² ; Šedá	www.wago.com/769-125
	Obj. č.: 769-126 2vodičová pružinová svorkovnice; 4 mm ² ; 6pól.; 4,00 mm ² ; Šedá	www.wago.com/769-126
	Obj. č.: 769-127 2vodičová pružinová svorkovnice; 4 mm ² ; 7pól.; 4,00 mm ² ; Šedá	www.wago.com/769-127
	Obj. č.: 769-128 2vodičová pružinová svorkovnice; 4 mm ² ; 8pól.; 4,00 mm ² ; Šedá	www.wago.com/769-128
	Obj. č.: 769-130 2vodičová pružinová svorkovnice; 4 mm ² ; 10pól.; 4,00 mm ² ; Šedá	www.wago.com/769-130
	Obj. č.: 769-131 2vodičová pružinová svorkovnice; 4 mm ² ; 11pól.; 4,00 mm ² ; Šedá	www.wago.com/769-131
	Obj. č.: 769-132 2vodičová pružinová svorkovnice; 4 mm ² ; 12pól.; 4,00 mm ² ; Šedá	www.wago.com/769-132
	Obj. č.: 769-133 2vodičová pružinová svorkovnice; 4 mm ² ; 13pól.; 4,00 mm ² ; Šedá	www.wago.com/769-133
	Obj. č.: 769-134 2vodičová pružinová svorkovnice; 4 mm ² ; 14pól.; 4,00 mm ² ; Šedá	www.wago.com/769-134
	Obj. č.: 769-135 2vodičová pružinová svorkovnice; 4 mm ² ; 15pól.; 4,00 mm ² ; Šedá	www.wago.com/769-135

Ke stažení

Documentation

Additional Information

Technical explanations	03-Apr-2019	pdf 2,1 MB	Stáhnout
------------------------	-------------	---------------	----------

CAD/CAE-Data

CAD data

2D/3D Models 769-669	URL	Stáhnout
----------------------	-----	----------

Handling Instructions

Assembly

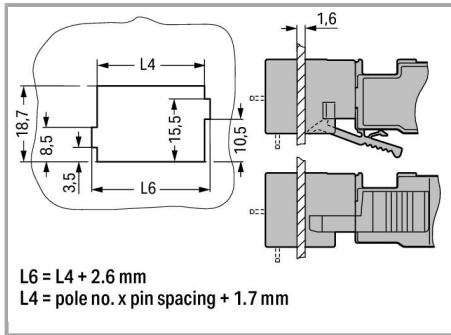

Cutout

Male headers with solder pins

Application

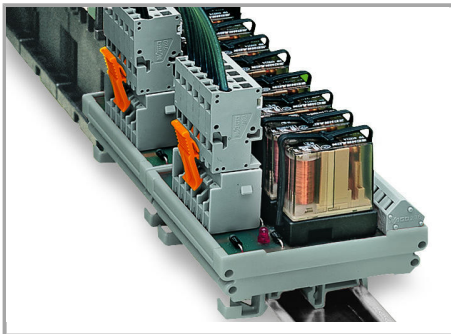

Male headers with straight solder pins and 1-conductor female plugs (picture shows a relay module)

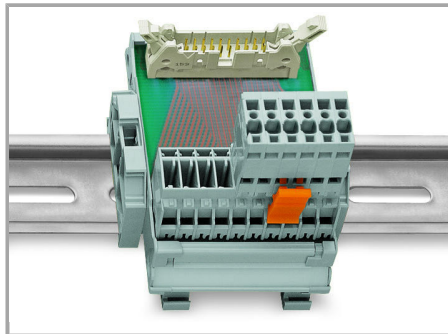

Male headers with solder pins for printed circuit boards

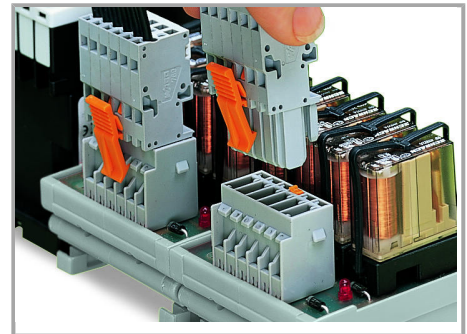

Pluggable PCB connection

Connection to a relay module inside the switchgear cabinet

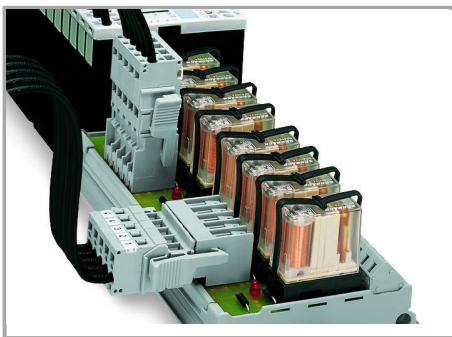

Male headers with solder pins:

Integrating PCB components into the system wiring.

Produktová rodina

X-COM

[Zobrazit všechny produkty z rodiny](#)

Změny vyhrazeny.

WAGO Elektro spol. sr. o.
Rozvodova 1116/36
143 00 Praha 12 - Modřany
Tel.: +420 261 090 143
Email: info.cz@wago.com, wago-cz@wago.com

Máte otázky ohledně našich produktů?
Kdykoli nám zavolejte na číslo +420 261 090 143.