

Datový list | Objednací číslo: 769-645

Konektor s pájecími piny THT; 1.0 x 1.0 mm solder pin; Rovné provedení;
Rozteč 5 mm; 15pól.; Šedá

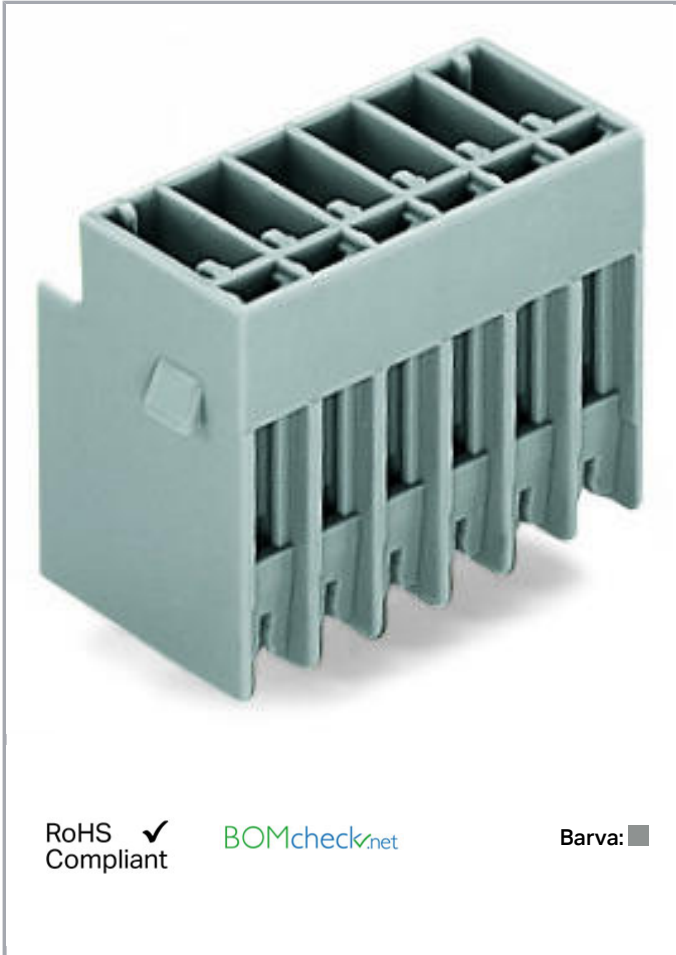

www.wago.com/769-645



RoHS Compliant

[BOMcheck.net](https://www.bomcheck.net)

Barva: ■

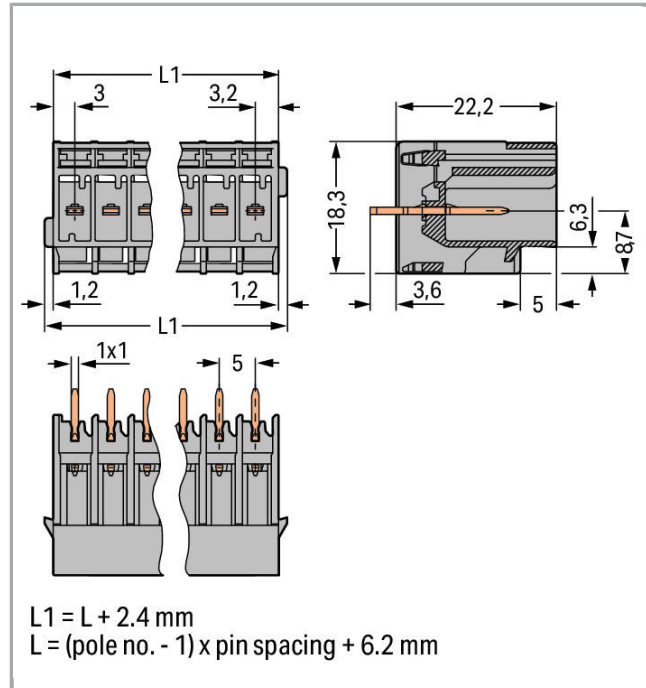

Data

Elektrické parametry

Ratings per IEC/EN 60664-1

Návrhové napětí (III / 3)	250 V
Návrhové rázové napětí (III / 3)	4 kV
Návrhové napětí (III/2)	500 V
Návrhové rázové napětí (III / 2)	4 kV
Jmenovitý proud	32 A
Legenda (návrhové hodnoty)	(III / 3) ≙ kategorie přepětí III / stupeň znečištění 3

Údaje o připojení

Počet pólů	15
------------	----



Celkový počet potenciálů	15
Počet úrovní	1

Geometrické údaje

Rozteč	5 mm / 0.197 inch
Šířka	78,6 mm / 3.094 inch
Výška od povrchu	22,2 mm / 0.874 inch
Hloubka	18,3 mm / 0.72 inch

Plug connection

Typ kontaktu (konektor)	Konektor (vidlice) / zástrčka
Typ připojení konektoru	na desky plošných spojů
Ochrana proti chybnému zapojení	No
Směr zapojení vůči desce plošných spojů	90°

PCB contact

Kontakt na desku plošných spojů	THT
---------------------------------	-----

Údaje o materiálu

barva	šedá
Izolační materiál	Polyamid 66 (PA 66)
Požární zatížení	0.314 MJ
Hmotnost	14.905 g

Obchodní údaje

Product Group	18 (X-COM-System)
Druh balení	BOX
Country of origin	PL
GTIN	4044918270809
Customs Tariff No.	85366990990

Atesty/certifikáty**Specifické atesty jednotlivých států**

Logo	Schválení	Doplňkový text schválení	Název certifikátu
	CCA DEKRA Certification B.V.	EN 60947	NTR NL- 7626
	CCA	EN 61984	2190419.02

DEKRA Certification B.V.



CCA DEKRA Certification B.V.	IEC 61984	NL-47799
--	-----------	----------





CSA DEKRA Certification B.V.	C22.2 No. 158	1101144
--	---------------	---------



KEMA/KEUR DEKRA Certification B.V.	EN 60947	2190419.01
--	----------	------------















Atesty UL















Logo	Schválení	Doplňkový text schválení	Název certifikátu
	UR Underwriters Laboratories Inc.	UL 1977	E45171-20010720
	UR Underwriters Laboratories Inc.	UL 1059	31.07.2019-E45172















Kompatibilní produkty

Female plug

	Obj. č.: 769-101 1 vodičová pružinová svorkovnice; 4 mm ² ; 1pól.; 4,00 mm ² ; Šedá	www.wago.com/769-101
	Obj. č.: 769-102 1 vodičová pružinová svorkovnice; 4 mm ² ; 2pól.; 4,00 mm ² ; Šedá	www.wago.com/769-102
	Obj. č.: 769-102/000-036 1 vodičová pružinová svorkovnice; 4 mm ² ; 2pól.; 4,00 mm ² ; Šedá / zelená – žlutá	www.wago.com/769-102/000-036
	Obj. č.: 769-102/000-037 1 vodičová pružinová svorkovnice; 4 mm ² ; 2pól.; 4,00 mm ² ; Zelená – žlutá / šedá	www.wago.com/769-102/000-037
	Obj. č.: 769-103 1 vodičová pružinová svorkovnice; 4 mm ² ; 3pól.; 4,00 mm ² ; Šedá	www.wago.com/769-103

	Obj. č.: 769-103/000-036 1 vodičová pružinová svorkovnice; 4 mm ² ; 3pól.; 4,00 mm ² ; Šedá / zelená – žlutá	www.wago.com/769-103/000-036
	Obj. č.: 769-103/000-037 1 vodičová pružinová svorkovnice; 4 mm ² ; 3pól.; 4,00 mm ² ; Zelená – žlutá / šedá	www.wago.com/769-103/000-037
	Obj. č.: 769-103/000-038 1 vodičová pružinová svorkovnice; 4 mm ² ; 3pól.; 4,00 mm ² ; Šedá / modrá / zelená – žlutá	www.wago.com/769-103/000-038
	Obj. č.: 769-103/000-039 1 vodičová pružinová svorkovnice; 4 mm ² ; 3pól.; 4,00 mm ² ; Zelená – žlutá, modrá, šedá	www.wago.com/769-103/000-039
	Obj. č.: 769-104 1 vodičová pružinová svorkovnice; 4 mm ² ; 4pól.; 4,00 mm ² ; Šedá	www.wago.com/769-104
	Obj. č.: 769-104/000-036 1 vodičová pružinová svorkovnice; 4 mm ² ; 4pól.; 4,00 mm ² ; Šedá / zelená – žlutá	www.wago.com/769-104/000-036
	Obj. č.: 769-104/000-037 1 vodičová pružinová svorkovnice; 4 mm ² ; 4pól.; 4,00 mm ² ; Zelená – žlutá / šedá	www.wago.com/769-104/000-037
	Obj. č.: 769-104/000-038 1 vodičová pružinová svorkovnice; 4 mm ² ; 4pól.; 4,00 mm ² ; Šedá / modrá / zelená – žlutá	www.wago.com/769-104/000-038
	Obj. č.: 769-104/000-039 1 vodičová pružinová svorkovnice; 4 mm ² ; 4pól.; 4,00 mm ² ; Zelená – žlutá, modrá, šedá	www.wago.com/769-104/000-039
	Obj. č.: 769-105 1 vodičová pružinová svorkovnice; 4 mm ² ; 5pól.; 4,00 mm ² ; Šedá	www.wago.com/769-105
	Obj. č.: 769-105/000-036 1 vodičová pružinová svorkovnice; 4 mm ² ; 5pól.; 4,00 mm ² ; Šedá / zelená – žlutá	www.wago.com/769-105/000-036
	Obj. č.: 769-105/000-037 1 vodičová pružinová svorkovnice; 4 mm ² ; 5pól.; 4,00 mm ² ; Zelená – žlutá / šedá	www.wago.com/769-105/000-037
	Obj. č.: 769-105/000-038 1 vodičová pružinová svorkovnice; 4 mm ² ; 5pól.; 4,00 mm ² ; Šedá / modrá / zelená – žlutá	www.wago.com/769-105/000-038
	Obj. č.: 769-105/000-039 1 vodičová pružinová svorkovnice; 4 mm ² ; 5pól.; 4,00 mm ² ; Zelená – žlutá, modrá, šedá	www.wago.com/769-105/000-039
	Obj. č.: 769-106 1 vodičová pružinová svorkovnice; 4 mm ² ; 6pól.; 4,00 mm ² ; Šedá	www.wago.com/769-106

	Obj. č.: 769-106/000-006 1 vodičová pružinová svorkovnice; 4 mm ² ; 6pól.; 4,00 mm ² ; Modrá	www.wago.com/769-106/000-006
	Obj. č.: 769-106/000-036 1 vodičová pružinová svorkovnice; 4 mm ² ; 6pól.; 4,00 mm ² ; Šedá / zelená – žlutá	www.wago.com/769-106/000-036
	Obj. č.: 769-106/000-037 1 vodičová pružinová svorkovnice; 4 mm ² ; 6pól.; 4,00 mm ² ; Zelená – žlutá / šedá	www.wago.com/769-106/000-037
	Obj. č.: 769-106/000-038 1 vodičová pružinová svorkovnice; 4 mm ² ; 6pól.; 4,00 mm ² ; Šedá / modrá / zelená – žlutá	www.wago.com/769-106/000-038
	Obj. č.: 769-106/000-039 1 vodičová pružinová svorkovnice; 4 mm ² ; 6pól.; 4,00 mm ² ; Zelená – žlutá, modrá, šedá	www.wago.com/769-106/000-039
	Obj. č.: 769-107 1 vodičová pružinová svorkovnice; 4 mm ² ; 7pól.; 4,00 mm ² ; Šedá	www.wago.com/769-107
	Obj. č.: 769-107/000-036 1 vodičová pružinová svorkovnice; 4 mm ² ; 7pól.; 4,00 mm ² ; Šedá / zelená – žlutá	www.wago.com/769-107/000-036
	Obj. č.: 769-107/000-037 1 vodičová pružinová svorkovnice; 4 mm ² ; 7pól.; 4,00 mm ² ; Zelená – žlutá / šedá	www.wago.com/769-107/000-037
	Obj. č.: 769-107/000-038 1 vodičová pružinová svorkovnice; 4 mm ² ; 7pól.; 4,00 mm ² ; Šedá / modrá / zelená – žlutá	www.wago.com/769-107/000-038
	Obj. č.: 769-107/000-039 1 vodičová pružinová svorkovnice; 4 mm ² ; 7pól.; 4,00 mm ² ; Zelená – žlutá, modrá, šedá	www.wago.com/769-107/000-039
	Obj. č.: 769-108 1 vodičová pružinová svorkovnice; 4 mm ² ; 8pól.; 4,00 mm ² ; Šedá	www.wago.com/769-108
	Obj. č.: 769-108/000-036 1 vodičová pružinová svorkovnice; 4 mm ² ; 8pól.; 4,00 mm ² ; Šedá / zelená – žlutá	www.wago.com/769-108/000-036
	Obj. č.: 769-108/000-037 1 vodičová pružinová svorkovnice; 4 mm ² ; 8pól.; 4,00 mm ² ; Zelená – žlutá / šedá	www.wago.com/769-108/000-037
	Obj. č.: 769-108/000-038 1 vodičová pružinová svorkovnice; 4 mm ² ; 8pól.; 4,00 mm ² ; Šedá / modrá / zelená – žlutá	www.wago.com/769-108/000-038
	Obj. č.: 769-108/000-039 1 vodičová pružinová svorkovnice; 4 mm ² ; 8pól.; 4,00 mm ² ; Zelená – žlutá, modrá, šedá	www.wago.com/769-108/000-039

	Obj. č.: 769-109 1 vodičová pružinová svorkovnice; 4 mm ² ; 9pól.; 4,00 mm ² ; Šedá	www.wago.com/769-109
	Obj. č.: 769-109/000-036 1 vodičová pružinová svorkovnice; 4 mm ² ; 9pól.; 4,00 mm ² ; Šedá / zelená – žlutá	www.wago.com/769-109/000-036
	Obj. č.: 769-109/000-037 1 vodičová pružinová svorkovnice; 4 mm ² ; 9pól.; 4,00 mm ² ; Zelená – žlutá / šedá	www.wago.com/769-109/000-037
	Obj. č.: 769-109/000-038 1 vodičová pružinová svorkovnice; 4 mm ² ; 9pól.; 4,00 mm ² ; Šedá / modrá / zelená – žlutá	www.wago.com/769-109/000-038
	Obj. č.: 769-109/000-039 1 vodičová pružinová svorkovnice; 4 mm ² ; 9pól.; 4,00 mm ² ; Zelená – žlutá, modrá, šedá	www.wago.com/769-109/000-039
	Obj. č.: 769-110 1 vodičová pružinová svorkovnice; 4 mm ² ; 10pól.; 4,00 mm ² ; Šedá	www.wago.com/769-110
	Obj. č.: 769-110/000-036 1 vodičová pružinová svorkovnice; 4 mm ² ; 10pól.; 4,00 mm ² ; Šedá / zelená – žlutá	www.wago.com/769-110/000-036
	Obj. č.: 769-110/000-037 1 vodičová pružinová svorkovnice; 4 mm ² ; 10pól.; 4,00 mm ² ; Zelená – žlutá / šedá	www.wago.com/769-110/000-037
	Obj. č.: 769-110/000-038 1 vodičová pružinová svorkovnice; 4 mm ² ; 10pól.; 4,00 mm ² ; Šedá / modrá / zelená – žlutá	www.wago.com/769-110/000-038
	Obj. č.: 769-110/000-039 1 vodičová pružinová svorkovnice; 4 mm ² ; 10pól.; 4,00 mm ² ; Zelená – žlutá, modrá, šedá	www.wago.com/769-110/000-039
	Obj. č.: 769-111 1 vodičová pružinová svorkovnice; 4 mm ² ; 11pól.; 4,00 mm ² ; Šedá	www.wago.com/769-111
	Obj. č.: 769-111/000-036 1 vodičová pružinová svorkovnice; 4 mm ² ; 11pól.; 4,00 mm ² ; Šedá / zelená – žlutá	www.wago.com/769-111/000-036
	Obj. č.: 769-111/000-037 1 vodičová pružinová svorkovnice; 4 mm ² ; 11pól.; 4,00 mm ² ; Zelená – žlutá / šedá	www.wago.com/769-111/000-037
	Obj. č.: 769-111/000-038 1 vodičová pružinová svorkovnice; 4 mm ² ; 11pól.; 4,00 mm ² ; Šedá / modrá / zelená – žlutá	www.wago.com/769-111/000-038
	Obj. č.: 769-111/000-039 1 vodičová pružinová svorkovnice; 4 mm ² ; 11pól.; 4,00 mm ² ; Zelená – žlutá, modrá, šedá	www.wago.com/769-111/000-039
	Obj. č.: 769-112 1 vodičová pružinová svorkovnice; 4 mm ² ; 12pól.; 4,00 mm ² ; Šedá	www.wago.com/769-112

**Obj. č.: 769-112/000-036**1 vodičová pružinová svorkovnice; 4 mm²; 12pól.; 4,00 mm²; Šedá / zelená – žlutáwww.wago.com/769-112/000-036**Obj. č.: 769-112/000-037**1 vodičová pružinová svorkovnice; 4 mm²; 12pól.; 4,00 mm²; Zelená – žlutá / šedáwww.wago.com/769-112/000-037**Obj. č.: 769-112/000-038**1 vodičová pružinová svorkovnice; 4 mm²; 12pól.; 4,00 mm²; Šedá / modrá / zelená – žlutáwww.wago.com/769-112/000-038**Obj. č.: 769-112/000-039**1 vodičová pružinová svorkovnice; 4 mm²; 12pól.; 4,00 mm²; Zelená – žlutá, modrá, šedáwww.wago.com/769-112/000-039**Obj. č.: 769-113**1 vodičová pružinová svorkovnice; 4 mm²; 13pól.; 4,00 mm²; Šedáwww.wago.com/769-113**Obj. č.: 769-113/000-036**1 vodičová pružinová svorkovnice; 4 mm²; 13pól.; 4,00 mm²; Šedá / zelená – žlutáwww.wago.com/769-113/000-036**Obj. č.: 769-113/000-037**1 vodičová pružinová svorkovnice; 4 mm²; 13pól.; 4,00 mm²; Zelená – žlutá / šedáwww.wago.com/769-113/000-037**Obj. č.: 769-113/000-038**1 vodičová pružinová svorkovnice; 4 mm²; 13pól.; 4,00 mm²; Šedá / modrá / zelená – žlutáwww.wago.com/769-113/000-038**Obj. č.: 769-113/000-039**1 vodičová pružinová svorkovnice; 4 mm²; 13pól.; 4,00 mm²; Zelená – žlutá, modrá, šedáwww.wago.com/769-113/000-039**Obj. č.: 769-114**1 vodičová pružinová svorkovnice; 4 mm²; 14pól.; 4,00 mm²; Šedáwww.wago.com/769-114**Obj. č.: 769-114/000-036**1 vodičová pružinová svorkovnice; 4 mm²; 14pól.; 4,00 mm²; Šedá / zelená – žlutáwww.wago.com/769-114/000-036**Obj. č.: 769-114/000-037**1 vodičová pružinová svorkovnice; 4 mm²; 14pól.; 4,00 mm²; Zelená – žlutá / šedáwww.wago.com/769-114/000-037**Obj. č.: 769-114/000-038**1 vodičová pružinová svorkovnice; 4 mm²; 14pól.; 4,00 mm²; Šedá / modrá / zelená – žlutáwww.wago.com/769-114/000-038**Obj. č.: 769-114/000-039**1 vodičová pružinová svorkovnice; 4 mm²; 14pól.; 4,00 mm²; Zelená – žlutá, modrá, šedáwww.wago.com/769-114/000-039



Obj. č.: 769-115/000-036

1 vodičová pružinová svorkovnice; 4 mm²; 15pól.; 4,00 mm²; Šedá / zelená – žlutá

www.wago.com/769-115/000-036



Obj. č.: 769-115/000-037

1 vodičová pružinová svorkovnice; 4 mm²; 15pól.; 4,00 mm²; Zelená – žlutá / šedá

www.wago.com/769-115/000-037



Obj. č.: 769-115/000-038

1 vodičová pružinová svorkovnice; 4 mm²; 15pól.; 4,00 mm²; Šedá / modrá / zelená – žlutá

www.wago.com/769-115/000-038



Obj. č.: 769-115/000-039

1 vodičová pružinová svorkovnice; 4 mm²; 15pól.; 4,00 mm²; Zelená – žlutá, modrá, šedá

www.wago.com/769-115/000-039



Obj. č.: 769-121

2 vodičová pružinová svorkovnice; 4 mm²; 1pól.; 4,00 mm²; Šedá

www.wago.com/769-121



Obj. č.: 769-122

2 vodičová pružinová svorkovnice; 4 mm²; 2pól.; 4,00 mm²; Šedá

www.wago.com/769-122



Obj. č.: 769-123

2 vodičová pružinová svorkovnice; 4 mm²; 3pól.; 4,00 mm²; Šedá

www.wago.com/769-123



Obj. č.: 769-124

2 vodičová pružinová svorkovnice; 4 mm²; 4pól.; 4,00 mm²; Šedá

www.wago.com/769-124



Obj. č.: 769-125

2 vodičová pružinová svorkovnice; 4 mm²; 5pól.; 4,00 mm²; Šedá

www.wago.com/769-125



Obj. č.: 769-126

2 vodičová pružinová svorkovnice; 4 mm²; 6pól.; 4,00 mm²; Šedá

www.wago.com/769-126



Obj. č.: 769-127

2 vodičová pružinová svorkovnice; 4 mm²; 7pól.; 4,00 mm²; Šedá

www.wago.com/769-127



Obj. č.: 769-128

2 vodičová pružinová svorkovnice; 4 mm²; 8pól.; 4,00 mm²; Šedá

www.wago.com/769-128



Obj. č.: 769-129

2 vodičová pružinová svorkovnice; 4 mm²; 9pól.; 4,00 mm²; Šedá

www.wago.com/769-129



Obj. č.: 769-130

2 vodičová pružinová svorkovnice; 4 mm²; 10pól.; 4,00 mm²; Šedá

www.wago.com/769-130



Obj. č.: 769-131

2 vodičová pružinová svorkovnice; 4 mm²; 11pól.; 4,00 mm²; Šedá

www.wago.com/769-131



Obj. č.: 769-132

2 vodičová pružinová svorkovnice; 4 mm²; 12pól.; 4,00 mm²; Šedá

www.wago.com/769-132



Obj. č.: 769-133

2 vodičová pružinová svorkovnice; 4 mm²; 13pól.; 4,00 mm²; Šedá

www.wago.com/769-133



Obj. č.: 769-134

2 vodičová pružinová svorkovnice; 4 mm²; 14pól.; 4,00 mm²; Šedá

www.wago.com/769-134

Coding



Obj. č.: 769-435

Kódovací kolík; Ke kódování pružinových svorkovnic; Pro základní svorky / konektory s pájecími piny;

Oranžová

www.wago.com/769-435

Marking accessories



Obj. č.: 210-831

Popisovací páska; Na cívce; Šířka 2,3 mm; Bez potisku; Samolepicí; Bílá

www.wago.com/210-831



Obj. č.: 210-832

Popisovací páska; Na cívce; Šířka 3 mm; Bez potisku; Samolepicí; Bílá

www.wago.com/210-832



Obj. č.: 210-833

Popisovací páska; Na cívce; Šířka 6 mm; Bez potisku; Samolepicí; Bílá

www.wago.com/210-833



Obj. č.: 210-834

Popisovací páska; Na cívce; Šířka 5 mm; Bez potisku; Samolepicí; Bílá

www.wago.com/210-834

Ke stažení

Documentation

Additional Information

Technical explanations

03-Apr-2019

pdf
2,1 MB

Stáhnout

CAD/CAE-Data

CAD data

2D/3D Models 769-645

URL

Stáhnout

Handling Instructions

Assembly

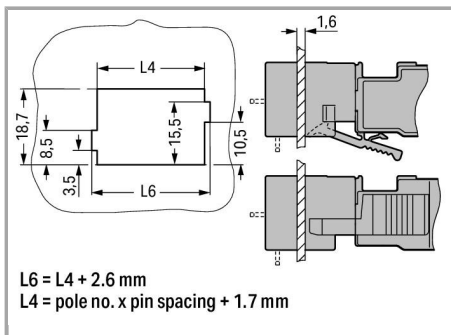

Cutout

Male headers with solder pins

Application

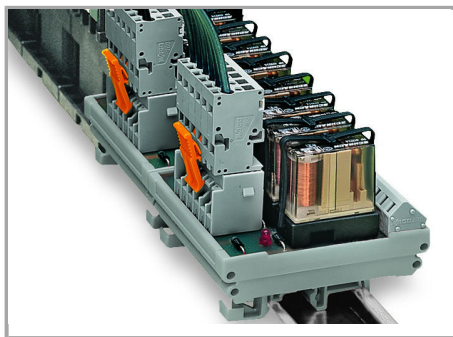

Male headers with straight solder pins and 1-conductor female plugs (picture shows a relay module)

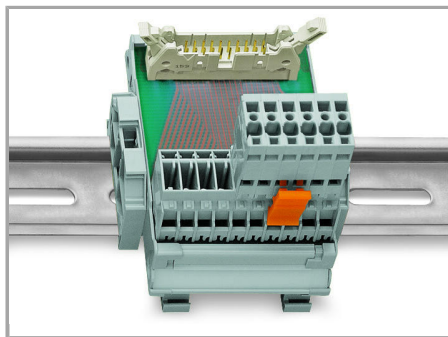

Male headers with solder pins for printed circuit boards

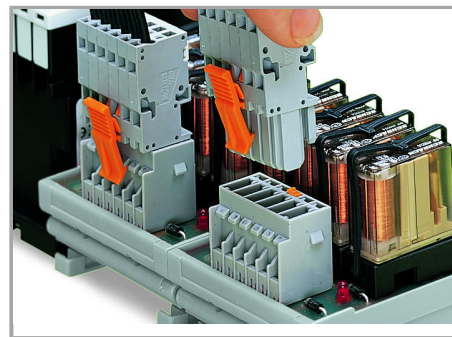

Pluggable PCB connection

Connection to a relay module inside the switchgear cabinet

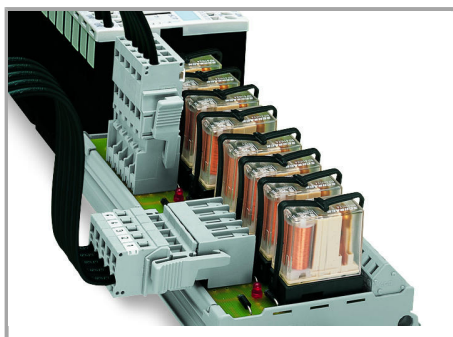

Male headers with solder pins:

Integrating PCB components into the system wiring.

Produktová rodina

X-COM

[Zobrazit všechny produkty z rodiny](#)

Změny vyhrazeny.

WAGO Elektro spol. sr. o.
Rozvodova 1116/36
143 00 Praha 12 - Modřany
Tel.: +420 261 090 143
Email: info.cz@wago.com, wago-cz@wago.com

Máte otázky ohledně našich produktů?
Kdykoli nám zavolejte na číslo +420 261 090 143.