

Datový list | Objednáací číslo: 769-641/004-000

THT male header; 1.0 x 1.0 mm solder pin; straight; Pin spacing 5 mm; 11-pole; gray

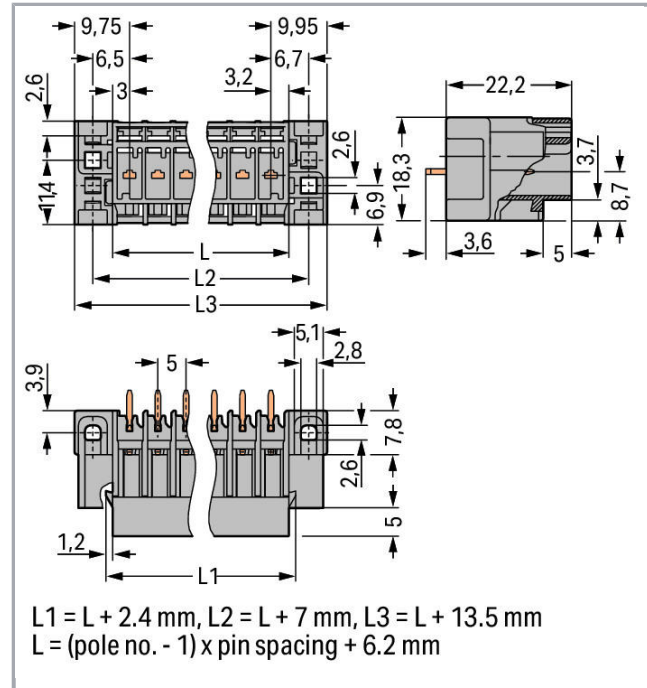

www.wago.com/769-641/004-000



RoHS Compliant

BOMcheck.net

Barva: ■

Data

Elektrické parametry

Ratings per IEC/EN 60664-1

Návrhové napětí (III / 3)	250 V
Návrhové rázové napětí (III / 3)	4 kV
Návrhové napětí (III/2)	500 V
Návrhové rázové napětí (III / 2)	4 kV
Jmenovitý proud	32 A
Legenda (návrhové hodnoty)	(III / 3) \triangleq kategorie přepětí III / stupeň znečištění 3

Údaje o připojení

Počet pólů	11
Celkový počet potenciálů	11
Počet úrovní	1

**Geometrické údaje**

Rozteč	5 mm / 0.197 inch
Šířka	69,7 mm / 2.744 inch
Výška od povrchu	22,2 mm / 0.874 inch
Hloubka	18,3 mm / 0.72 inch

Mechanické parametry

Způsob upevnění	Upevňovací příruba
-----------------	--------------------

Plug connection

Typ kontaktu (konektor)	Konektor (vidlice) / zástrčka
Typ připojení konektoru	na desky plošných spojů
Ochrana proti chybnému zapojení	No
Směr zapojení vůči desce plošných spojů	90°

PCB contact

Kontakt na desku plošných spojů	THT
---------------------------------	-----

Údaje o materiálu

barva	Šedá
Izolační materiál	Polyamid 66 (PA 66)
Požární zatížení	0.27 MJ
Hmotnost	12.265 g

Obchodní údaje

Product Group	18 (X-COM-System)
Druh balení	BOX
Country of origin	PL
GTIN	4017332412827
Customs Tariff No.	85366990990

Atesty/certifikáty**Specifické atesty jednotlivých států**

Logo	Schválení	Doplňkový text schválení	Název certifikátu
	CCA DEKRA Certification B.V.	EN 60947	NTR NL- 7626
	CCA	EN 61984	2190419.02

DEKRA Certification B.V.



CCA DEKRA Certification B.V.	IEC 61984	NL-47799
---------------------------------	-----------	----------





CSA DEKRA Certification B.V.	C22.2 No. 158	1101144
---------------------------------	---------------	---------





KEMA/KEUR DEKRA Certification B.V.	EN 60947	2190419.01
---------------------------------------	----------	------------

Atesty UL

Logo	Schválení	Doplňkový text schválení	Název certifikátu
	UR Underwriters Laboratories Inc.	UL 1977	E45171- 20010720
	UR Underwriters Laboratories Inc.	UL 1059	31.07.2019- E45172

Kompatibilní produkty

















Marking accessories















	Obj. č.: 210-831 Popisovací páska; Na cívce; Šířka 2,3 mm; Bez potisku; Samolepicí; Bílá	www.wago.com/210-831
	Obj. č.: 210-832 Popisovací páska; Na cívce; Šířka 3 mm; Bez potisku; Samolepicí; Bílá	www.wago.com/210-832
	Obj. č.: 210-833 Popisovací páska; Na cívce; Šířka 6 mm; Bez potisku; Samolepicí; Bílá	www.wago.com/210-833
	Obj. č.: 210-834 Popisovací páska; Na cívce; Šířka 5 mm; Bez potisku; Samolepicí; Bílá	www.wago.com/210-834















Coding













	Obj. č.: 769-435 Kódovací kolík; Ke kódování pružinových svorkovnic; Pro základní svorky / konektory s pájecími piny; Oranžová	www.wago.com/769-435
--	---	--

Female plug

	Obj. č.: 769-101 1 vodičová pružinová svorkovnice; 4 mm ² ; 1pól.; 4,00 mm ² ; Šedá	www.wago.com/769-101
	Obj. č.: 769-102 1 vodičová pružinová svorkovnice; 4 mm ² ; 2pól.; 4,00 mm ² ; Šedá	www.wago.com/769-102
	Obj. č.: 769-102/000-036 1 vodičová pružinová svorkovnice; 4 mm ² ; 2pól.; 4,00 mm ² ; Šedá / zelená – žlutá	www.wago.com/769-102/000-036
	Obj. č.: 769-102/000-037 1 vodičová pružinová svorkovnice; 4 mm ² ; 2pól.; 4,00 mm ² ; Zelená – žlutá / šedá	www.wago.com/769-102/000-037
	Obj. č.: 769-103 1 vodičová pružinová svorkovnice; 4 mm ² ; 3pól.; 4,00 mm ² ; Šedá	www.wago.com/769-103
	Obj. č.: 769-103/000-036 1 vodičová pružinová svorkovnice; 4 mm ² ; 3pól.; 4,00 mm ² ; Šedá / zelená – žlutá	www.wago.com/769-103/000-036
	Obj. č.: 769-103/000-037 1 vodičová pružinová svorkovnice; 4 mm ² ; 3pól.; 4,00 mm ² ; Zelená – žlutá / šedá	www.wago.com/769-103/000-037
	Obj. č.: 769-103/000-038 1 vodičová pružinová svorkovnice; 4 mm ² ; 3pól.; 4,00 mm ² ; Šedá / modrá / zelená – žlutá	www.wago.com/769-103/000-038
	Obj. č.: 769-103/000-039 1 vodičová pružinová svorkovnice; 4 mm ² ; 3pól.; 4,00 mm ² ; Zelená – žlutá, modrá, šedá	www.wago.com/769-103/000-039
	Obj. č.: 769-104 1 vodičová pružinová svorkovnice; 4 mm ² ; 4pól.; 4,00 mm ² ; Šedá	www.wago.com/769-104
	Obj. č.: 769-104/000-036 1 vodičová pružinová svorkovnice; 4 mm ² ; 4pól.; 4,00 mm ² ; Šedá / zelená – žlutá	www.wago.com/769-104/000-036
	Obj. č.: 769-104/000-037 1 vodičová pružinová svorkovnice; 4 mm ² ; 4pól.; 4,00 mm ² ; Zelená – žlutá / šedá	www.wago.com/769-104/000-037
	Obj. č.: 769-104/000-038 1 vodičová pružinová svorkovnice; 4 mm ² ; 4pól.; 4,00 mm ² ; Šedá / modrá / zelená – žlutá	www.wago.com/769-104/000-038
	Obj. č.: 769-104/000-039 1 vodičová pružinová svorkovnice; 4 mm ² ; 4pól.; 4,00 mm ² ; Zelená – žlutá, modrá, šedá	www.wago.com/769-104/000-039
	Obj. č.: 769-105 1 vodičová pružinová svorkovnice; 4 mm ² ; 5pól.; 4,00 mm ² ; Šedá	www.wago.com/769-105
	Obj. č.: 769-105/000-036 1 vodičová pružinová svorkovnice; 4 mm ² ; 5pól.; 4,00 mm ² ; Šedá / zelená – žlutá	www.wago.com/769-105/000-036

	Obj. č.: 769-105/000-037 1 vodičová pružinová svorkovnice; 4 mm ² ; 5pól.; 4,00 mm ² ; Zelená – žlutá / šedá	www.wago.com/769-105/000-037
	Obj. č.: 769-105/000-038 1 vodičová pružinová svorkovnice; 4 mm ² ; 5pól.; 4,00 mm ² ; Šedá / modrá / zelená – žlutá	www.wago.com/769-105/000-038
	Obj. č.: 769-105/000-039 1 vodičová pružinová svorkovnice; 4 mm ² ; 5pól.; 4,00 mm ² ; Zelená – žlutá, modrá, šedá	www.wago.com/769-105/000-039
	Obj. č.: 769-106 1 vodičová pružinová svorkovnice; 4 mm ² ; 6pól.; 4,00 mm ² ; Šedá	www.wago.com/769-106
	Obj. č.: 769-106/000-006 1 vodičová pružinová svorkovnice; 4 mm ² ; 6pól.; 4,00 mm ² ; Modrá	www.wago.com/769-106/000-006
	Obj. č.: 769-106/000-036 1 vodičová pružinová svorkovnice; 4 mm ² ; 6pól.; 4,00 mm ² ; Šedá / zelená – žlutá	www.wago.com/769-106/000-036
	Obj. č.: 769-106/000-037 1 vodičová pružinová svorkovnice; 4 mm ² ; 6pól.; 4,00 mm ² ; Zelená – žlutá / šedá	www.wago.com/769-106/000-037
	Obj. č.: 769-106/000-038 1 vodičová pružinová svorkovnice; 4 mm ² ; 6pól.; 4,00 mm ² ; Šedá / modrá / zelená – žlutá	www.wago.com/769-106/000-038
	Obj. č.: 769-106/000-039 1 vodičová pružinová svorkovnice; 4 mm ² ; 6pól.; 4,00 mm ² ; Zelená – žlutá, modrá, šedá	www.wago.com/769-106/000-039
	Obj. č.: 769-107 1 vodičová pružinová svorkovnice; 4 mm ² ; 7pól.; 4,00 mm ² ; Šedá	www.wago.com/769-107
	Obj. č.: 769-107/000-036 1 vodičová pružinová svorkovnice; 4 mm ² ; 7pól.; 4,00 mm ² ; Šedá / zelená – žlutá	www.wago.com/769-107/000-036
	Obj. č.: 769-107/000-037 1 vodičová pružinová svorkovnice; 4 mm ² ; 7pól.; 4,00 mm ² ; Zelená – žlutá / šedá	www.wago.com/769-107/000-037
	Obj. č.: 769-107/000-038 1 vodičová pružinová svorkovnice; 4 mm ² ; 7pól.; 4,00 mm ² ; Šedá / modrá / zelená – žlutá	www.wago.com/769-107/000-038
	Obj. č.: 769-107/000-039 1 vodičová pružinová svorkovnice; 4 mm ² ; 7pól.; 4,00 mm ² ; Zelená – žlutá, modrá, šedá	www.wago.com/769-107/000-039
	Obj. č.: 769-108 1 vodičová pružinová svorkovnice; 4 mm ² ; 8pól.; 4,00 mm ² ; Šedá	www.wago.com/769-108

	Obj. č.: 769-108/000-036 1 vodičová pružinová svorkovnice; 4 mm ² ; 8pól.; 4,00 mm ² ; Šedá / zelená – žlutá	www.wago.com/769-108/000-036
	Obj. č.: 769-108/000-037 1 vodičová pružinová svorkovnice; 4 mm ² ; 8pól.; 4,00 mm ² ; Zelená – žlutá / šedá	www.wago.com/769-108/000-037
	Obj. č.: 769-108/000-038 1 vodičová pružinová svorkovnice; 4 mm ² ; 8pól.; 4,00 mm ² ; Šedá / modrá / zelená – žlutá	www.wago.com/769-108/000-038
	Obj. č.: 769-108/000-039 1 vodičová pružinová svorkovnice; 4 mm ² ; 8pól.; 4,00 mm ² ; Zelená – žlutá, modrá, šedá	www.wago.com/769-108/000-039
	Obj. č.: 769-109 1 vodičová pružinová svorkovnice; 4 mm ² ; 9pól.; 4,00 mm ² ; Šedá	www.wago.com/769-109
	Obj. č.: 769-109/000-036 1 vodičová pružinová svorkovnice; 4 mm ² ; 9pól.; 4,00 mm ² ; Šedá / zelená – žlutá	www.wago.com/769-109/000-036
	Obj. č.: 769-109/000-037 1 vodičová pružinová svorkovnice; 4 mm ² ; 9pól.; 4,00 mm ² ; Zelená – žlutá / šedá	www.wago.com/769-109/000-037
	Obj. č.: 769-109/000-038 1 vodičová pružinová svorkovnice; 4 mm ² ; 9pól.; 4,00 mm ² ; Šedá / modrá / zelená – žlutá	www.wago.com/769-109/000-038
	Obj. č.: 769-109/000-039 1 vodičová pružinová svorkovnice; 4 mm ² ; 9pól.; 4,00 mm ² ; Zelená – žlutá, modrá, šedá	www.wago.com/769-109/000-039
	Obj. č.: 769-110 1 vodičová pružinová svorkovnice; 4 mm ² ; 10pól.; 4,00 mm ² ; Šedá	www.wago.com/769-110
	Obj. č.: 769-110/000-036 1 vodičová pružinová svorkovnice; 4 mm ² ; 10pól.; 4,00 mm ² ; Šedá / zelená – žlutá	www.wago.com/769-110/000-036
	Obj. č.: 769-110/000-037 1 vodičová pružinová svorkovnice; 4 mm ² ; 10pól.; 4,00 mm ² ; Zelená – žlutá / šedá	www.wago.com/769-110/000-037
	Obj. č.: 769-110/000-038 1 vodičová pružinová svorkovnice; 4 mm ² ; 10pól.; 4,00 mm ² ; Šedá / modrá / zelená – žlutá	www.wago.com/769-110/000-038
	Obj. č.: 769-110/000-039 1 vodičová pružinová svorkovnice; 4 mm ² ; 10pól.; 4,00 mm ² ; Zelená – žlutá, modrá, šedá	www.wago.com/769-110/000-039
	Obj. č.: 769-111/000-036 1 vodičová pružinová svorkovnice; 4 mm ² ; 11pól.; 4,00 mm ² ; Šedá / zelená – žlutá	www.wago.com/769-111/000-036

	Obj. č.: 769-111/000-037 1vodičová pružinová svorkovnice; 4 mm ² ; 11pól.; 4,00 mm ² ; Zelená – žlutá / šedá	www.wago.com/769-111/000-037
	Obj. č.: 769-111/000-038 1vodičová pružinová svorkovnice; 4 mm ² ; 11pól.; 4,00 mm ² ; Šedá / modrá / zelená – žlutá	www.wago.com/769-111/000-038
	Obj. č.: 769-111/000-039 1vodičová pružinová svorkovnice; 4 mm ² ; 11pól.; 4,00 mm ² ; Zelená – žlutá, modrá, šedá	www.wago.com/769-111/000-039
	Obj. č.: 769-121 2vodičová pružinová svorkovnice; 4 mm ² ; 1pól.; 4,00 mm ² ; Šedá	www.wago.com/769-121
	Obj. č.: 769-122 2vodičová pružinová svorkovnice; 4 mm ² ; 2pól.; 4,00 mm ² ; Šedá	www.wago.com/769-122
	Obj. č.: 769-123 2vodičová pružinová svorkovnice; 4 mm ² ; 3pól.; 4,00 mm ² ; Šedá	www.wago.com/769-123
	Obj. č.: 769-124 2vodičová pružinová svorkovnice; 4 mm ² ; 4pól.; 4,00 mm ² ; Šedá	www.wago.com/769-124
	Obj. č.: 769-125 2vodičová pružinová svorkovnice; 4 mm ² ; 5pól.; 4,00 mm ² ; Šedá	www.wago.com/769-125
	Obj. č.: 769-126 2vodičová pružinová svorkovnice; 4 mm ² ; 6pól.; 4,00 mm ² ; Šedá	www.wago.com/769-126
	Obj. č.: 769-127 2vodičová pružinová svorkovnice; 4 mm ² ; 7pól.; 4,00 mm ² ; Šedá	www.wago.com/769-127
	Obj. č.: 769-128 2vodičová pružinová svorkovnice; 4 mm ² ; 8pól.; 4,00 mm ² ; Šedá	www.wago.com/769-128
	Obj. č.: 769-129 2vodičová pružinová svorkovnice; 4 mm ² ; 9pól.; 4,00 mm ² ; Šedá	www.wago.com/769-129
	Obj. č.: 769-130 2vodičová pružinová svorkovnice; 4 mm ² ; 10pól.; 4,00 mm ² ; Šedá	www.wago.com/769-130

Ke stažení

Documentation

Additional Information

Technical explanations	03-Apr-2019	pdf 2,1 MB	Stáhnout
------------------------	-------------	---------------	----------

CAD/CAE-Data

CAD data

2D/3D Models 769-641/004-000	URL	Stáhnout
------------------------------	-----	----------



Handling Instructions

Produktová rodina

X-COM

[Zobrazit všechny produkty z rodiny](#)

Změny vyhrazeny.

WAGO Elektro spol. sr. o.
Rozvodova 1116/36
143 00 Praha 12 - Modřany
Tel.: +420 261 090 143
Email: info.cz@wago.com, wago-cz@wago.com

Máte otázky ohledně našich produktů?
Kdykoli nám zavolejte na číslo +420 261 090 143.