

Datový list | Objednací číslo: 769-613/005-000

1 vodičový konektor s pájecími piny; Zajišťovací příruba; 4 mm²; Rozteč 5 mm; 13pól.; 4,00 mm²; Šedá

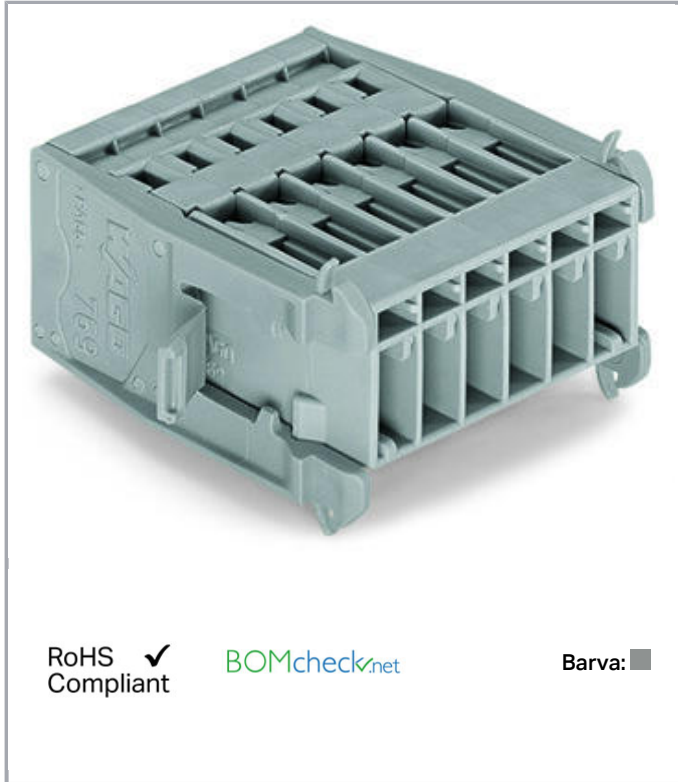

www.wago.com/769-613/005-000



RoHS Compliant

BOMcheck.net

Barva: ■

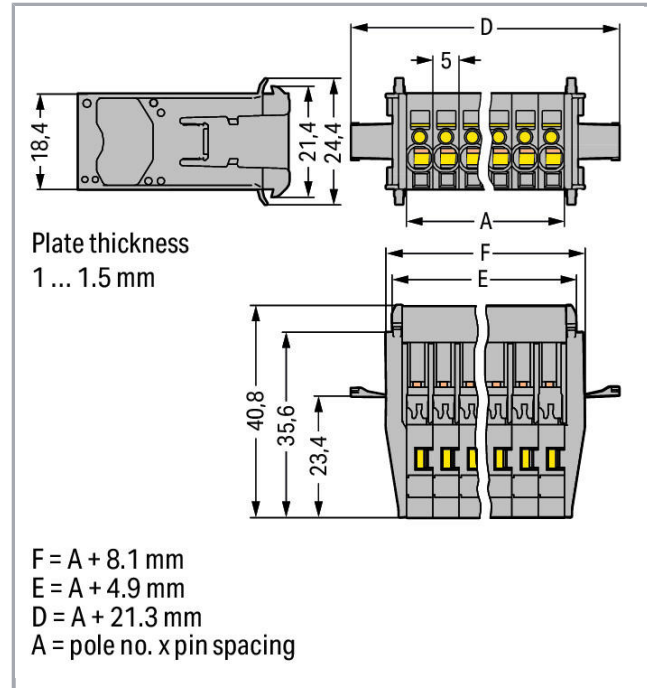

Data

Elektrické parametry

Ratings per IEC/EN 60664-1

Návrhové napětí (III / 3)	500 V
Návrhové rázové napětí (III / 3)	6 kV
Jmenovitý proud	32 A
Legenda (návrhové hodnoty)	(III / 3) ≙ kategorie přepětí III / stupeň znečištění 3

Údaje o připojení

Připojovací technika	CAGE CLAMP®
Způsob ovládání	Ovládací nástroj
Materiály připojitelných vodičů	Měď
Jmenovitý průřez	4 mm ²
Plný vodič	0,08 ... 4 mm ² / 28 ... 12 AWG
Jemně laněný vodič	0,08 ... 4 mm ² / 28 ... 12 AWG
Délka odizolování	8 ... 9 mm / 0.31 ... 0.35 palec



Počet pólů	13
Celkový počet kontaktních míst	13
Celkový počet potenciálů	13
Způsob zapojení	čelní připojení

Geometrické údaje

Rozteč	5 mm / 0.197 inch
Šířka	86,3 mm / 3.398 inch
Výška	24,4 mm / 0.961 inch
Hloubka	40,8 mm / 1.606 inch

Mechanické parametry

Způsob upevnění	Snap-in
-----------------	---------

Plug connection

Typ kontaktu (konektor)	Konektor (vidlice) / zástrčka
Typ připojení konektoru	pro vodiče

Údaje o materiálu

barva	Šedá
Izolační materiál	Polyamid 66 (PA 66)
Požární zatížení	0.798 MJ
Hmotnost	39.636 g

Obchodní údaje

Product Group	18 (X-COM-System)
Druh balení	BOX
Country of origin	PL
GTIN	4044918854535
Customs Tariff No.	85366990990

Atesty/certifikáty

Specifické atesty jednotlivých států

Logo	Schválení	Doplňkový text schválení	Název certifikátu
	CCA DEKRA Certification B.V.	EN 61984	2190419.02
	CCA	IEC 61984	NL-47799



DEKRA Certification B.V.

CSA
DEKRA Certification B.V.

C22.2 No. 158







1101144















Atesty UL















Logo	Schválení	Doplňkový text schválení	Název certifikátu
	UR Underwriters Laboratories Inc.	UL 1977	E45171- 20010720
	UR Underwriters Laboratories Inc.	UL 1059	31.07.2019- E45172

Kompatibilní produkty

Female plug

	Obj. č.: 769-101 1 vodičová pružinová svorkovnice; 4 mm ² ; 1pól.; 4,00 mm ² ; Šedá	www.wago.com/769-101
	Obj. č.: 769-101/000-016 1 vodičová pružinová svorkovnice; 4 mm ² ; 1pól.; 4,00 mm ² ; Zeleno-žlutá	www.wago.com/769-101/000-016
	Obj. č.: 769-102 1 vodičová pružinová svorkovnice; 4 mm ² ; 2pól.; 4,00 mm ² ; Šedá	www.wago.com/769-102
	Obj. č.: 769-102/000-036 1 vodičová pružinová svorkovnice; 4 mm ² ; 2pól.; 4,00 mm ² ; Šedá / zelená – žlutá	www.wago.com/769-102/000-036
	Obj. č.: 769-102/000-037 1 vodičová pružinová svorkovnice; 4 mm ² ; 2pól.; 4,00 mm ² ; Zelená – žlutá / šedá	www.wago.com/769-102/000-037
	Obj. č.: 769-103 1 vodičová pružinová svorkovnice; 4 mm ² ; 3pól.; 4,00 mm ² ; Šedá	www.wago.com/769-103
	Obj. č.: 769-103/000-036 1 vodičová pružinová svorkovnice; 4 mm ² ; 3pól.; 4,00 mm ² ; Šedá / zelená – žlutá	www.wago.com/769-103/000-036

	Obj. č.: 769-103/000-037 1 vodičová pružinová svorkovnice; 4 mm ² ; 3pól.; 4,00 mm ² ; Zelená – žlutá / šedá	www.wago.com/769-103/000-037
	Obj. č.: 769-103/000-038 1 vodičová pružinová svorkovnice; 4 mm ² ; 3pól.; 4,00 mm ² ; Šedá / modrá / zelená – žlutá	www.wago.com/769-103/000-038
	Obj. č.: 769-103/000-039 1 vodičová pružinová svorkovnice; 4 mm ² ; 3pól.; 4,00 mm ² ; Zelená – žlutá, modrá, šedá	www.wago.com/769-103/000-039
	Obj. č.: 769-104 1 vodičová pružinová svorkovnice; 4 mm ² ; 4pól.; 4,00 mm ² ; Šedá	www.wago.com/769-104
	Obj. č.: 769-104/000-036 1 vodičová pružinová svorkovnice; 4 mm ² ; 4pól.; 4,00 mm ² ; Šedá / zelená – žlutá	www.wago.com/769-104/000-036
	Obj. č.: 769-104/000-037 1 vodičová pružinová svorkovnice; 4 mm ² ; 4pól.; 4,00 mm ² ; Zelená – žlutá / šedá	www.wago.com/769-104/000-037
	Obj. č.: 769-104/000-038 1 vodičová pružinová svorkovnice; 4 mm ² ; 4pól.; 4,00 mm ² ; Šedá / modrá / zelená – žlutá	www.wago.com/769-104/000-038
	Obj. č.: 769-104/000-039 1 vodičová pružinová svorkovnice; 4 mm ² ; 4pól.; 4,00 mm ² ; Zelená – žlutá, modrá, šedá	www.wago.com/769-104/000-039
	Obj. č.: 769-105 1 vodičová pružinová svorkovnice; 4 mm ² ; 5pól.; 4,00 mm ² ; Šedá	www.wago.com/769-105
	Obj. č.: 769-105/000-036 1 vodičová pružinová svorkovnice; 4 mm ² ; 5pól.; 4,00 mm ² ; Šedá / zelená – žlutá	www.wago.com/769-105/000-036
	Obj. č.: 769-105/000-037 1 vodičová pružinová svorkovnice; 4 mm ² ; 5pól.; 4,00 mm ² ; Zelená – žlutá / šedá	www.wago.com/769-105/000-037
	Obj. č.: 769-105/000-038 1 vodičová pružinová svorkovnice; 4 mm ² ; 5pól.; 4,00 mm ² ; Šedá / modrá / zelená – žlutá	www.wago.com/769-105/000-038
	Obj. č.: 769-105/000-039 1 vodičová pružinová svorkovnice; 4 mm ² ; 5pól.; 4,00 mm ² ; Zelená – žlutá, modrá, šedá	www.wago.com/769-105/000-039
	Obj. č.: 769-106 1 vodičová pružinová svorkovnice; 4 mm ² ; 6pól.; 4,00 mm ² ; Šedá	www.wago.com/769-106
	Obj. č.: 769-106/000-006 1 vodičová pružinová svorkovnice; 4 mm ² ; 6pól.; 4,00 mm ² ; Modrá	www.wago.com/769-106/000-006

	Obj. č.: 769-106/000-036 1 vodičová pružinová svorkovnice; 4 mm ² ; 6pól.; 4,00 mm ² ; Šedá / zelená – žlutá	www.wago.com/769-106/000-036
	Obj. č.: 769-106/000-037 1 vodičová pružinová svorkovnice; 4 mm ² ; 6pól.; 4,00 mm ² ; Zelená – žlutá / šedá	www.wago.com/769-106/000-037
	Obj. č.: 769-106/000-038 1 vodičová pružinová svorkovnice; 4 mm ² ; 6pól.; 4,00 mm ² ; Šedá / modrá / zelená – žlutá	www.wago.com/769-106/000-038
	Obj. č.: 769-106/000-039 1 vodičová pružinová svorkovnice; 4 mm ² ; 6pól.; 4,00 mm ² ; Zelená – žlutá, modrá, šedá	www.wago.com/769-106/000-039
	Obj. č.: 769-107 1 vodičová pružinová svorkovnice; 4 mm ² ; 7pól.; 4,00 mm ² ; Šedá	www.wago.com/769-107
	Obj. č.: 769-107/000-036 1 vodičová pružinová svorkovnice; 4 mm ² ; 7pól.; 4,00 mm ² ; Šedá / zelená – žlutá	www.wago.com/769-107/000-036
	Obj. č.: 769-107/000-037 1 vodičová pružinová svorkovnice; 4 mm ² ; 7pól.; 4,00 mm ² ; Zelená – žlutá / šedá	www.wago.com/769-107/000-037
	Obj. č.: 769-107/000-038 1 vodičová pružinová svorkovnice; 4 mm ² ; 7pól.; 4,00 mm ² ; Šedá / modrá / zelená – žlutá	www.wago.com/769-107/000-038
	Obj. č.: 769-107/000-039 1 vodičová pružinová svorkovnice; 4 mm ² ; 7pól.; 4,00 mm ² ; Zelená – žlutá, modrá, šedá	www.wago.com/769-107/000-039
	Obj. č.: 769-108 1 vodičová pružinová svorkovnice; 4 mm ² ; 8pól.; 4,00 mm ² ; Šedá	www.wago.com/769-108
	Obj. č.: 769-108/000-036 1 vodičová pružinová svorkovnice; 4 mm ² ; 8pól.; 4,00 mm ² ; Šedá / zelená – žlutá	www.wago.com/769-108/000-036
	Obj. č.: 769-108/000-037 1 vodičová pružinová svorkovnice; 4 mm ² ; 8pól.; 4,00 mm ² ; Zelená – žlutá / šedá	www.wago.com/769-108/000-037
	Obj. č.: 769-108/000-038 1 vodičová pružinová svorkovnice; 4 mm ² ; 8pól.; 4,00 mm ² ; Šedá / modrá / zelená – žlutá	www.wago.com/769-108/000-038
	Obj. č.: 769-108/000-039 1 vodičová pružinová svorkovnice; 4 mm ² ; 8pól.; 4,00 mm ² ; Zelená – žlutá, modrá, šedá	www.wago.com/769-108/000-039
	Obj. č.: 769-109 1 vodičová pružinová svorkovnice; 4 mm ² ; 9pól.; 4,00 mm ² ; Šedá	www.wago.com/769-109
	Obj. č.: 769-109/000-036 1 vodičová pružinová svorkovnice; 4 mm ² ; 9pól.; 4,00 mm ² ; Šedá / zelená – žlutá	www.wago.com/769-109/000-036



Obj. č.: 769-109/000-037

1vodičová pružinová svorkovnice; 4 mm²; 9pól.; 4,00 mm²; Zelená – žlutá / šedá

www.wago.com/769-109/000-037



Obj. č.: 769-109/000-038

1vodičová pružinová svorkovnice; 4 mm²; 9pól.; 4,00 mm²; Šedá / modrá / zelená – žlutá

www.wago.com/769-109/000-038



Obj. č.: 769-109/000-039

1vodičová pružinová svorkovnice; 4 mm²; 9pól.; 4,00 mm²; Zelená – žlutá, modrá, šedá

www.wago.com/769-109/000-039



Obj. č.: 769-110

1vodičová pružinová svorkovnice; 4 mm²; 10pól.; 4,00 mm²; Šedá

www.wago.com/769-110



Obj. č.: 769-110/000-036

1vodičová pružinová svorkovnice; 4 mm²; 10pól.; 4,00 mm²; Šedá / zelená – žlutá

www.wago.com/769-110/000-036



Obj. č.: 769-110/000-037

1vodičová pružinová svorkovnice; 4 mm²; 10pól.; 4,00 mm²; Zelená – žlutá / šedá

www.wago.com/769-110/000-037



Obj. č.: 769-110/000-038

1vodičová pružinová svorkovnice; 4 mm²; 10pól.; 4,00 mm²; Šedá / modrá / zelená – žlutá

www.wago.com/769-110/000-038



Obj. č.: 769-110/000-039

1vodičová pružinová svorkovnice; 4 mm²; 10pól.; 4,00 mm²; Zelená – žlutá, modrá, šedá

www.wago.com/769-110/000-039



Obj. č.: 769-111

1vodičová pružinová svorkovnice; 4 mm²; 11pól.; 4,00 mm²; Šedá

www.wago.com/769-111



Obj. č.: 769-111/000-036

1vodičová pružinová svorkovnice; 4 mm²; 11pól.; 4,00 mm²; Šedá / zelená – žlutá

www.wago.com/769-111/000-036



Obj. č.: 769-111/000-037

1vodičová pružinová svorkovnice; 4 mm²; 11pól.; 4,00 mm²; Zelená – žlutá / šedá

www.wago.com/769-111/000-037



Obj. č.: 769-111/000-038

1vodičová pružinová svorkovnice; 4 mm²; 11pól.; 4,00 mm²; Šedá / modrá / zelená – žlutá

www.wago.com/769-111/000-038



Obj. č.: 769-111/000-039

1vodičová pružinová svorkovnice; 4 mm²; 11pól.; 4,00 mm²; Zelená – žlutá, modrá, šedá

www.wago.com/769-111/000-039



Obj. č.: 769-112

1vodičová pružinová svorkovnice; 4 mm²; 12pól.; 4,00 mm²; Šedá

















www.wago.com/769-112



Obj. č.: 769-112/000-036

1vodičová pružinová svorkovnice; 4 mm²; 12pól.; 4,00 mm²; Šedá / zelená – žlutá

www.wago.com/769-112/000-036

	Obj. č.: 769-112/000-037 1vodičová pružinová svorkovnice; 4 mm ² ; 12pól.; 4,00 mm ² ; Zelená – žlutá / šedá	www.wago.com/769-112/000-037
	Obj. č.: 769-112/000-038 1vodičová pružinová svorkovnice; 4 mm ² ; 12pól.; 4,00 mm ² ; Šedá / modrá / zelená – žlutá	www.wago.com/769-112/000-038
	Obj. č.: 769-112/000-039 1vodičová pružinová svorkovnice; 4 mm ² ; 12pól.; 4,00 mm ² ; Zelená – žlutá, modrá, šedá	www.wago.com/769-112/000-039
	Obj. č.: 769-113/000-036 1vodičová pružinová svorkovnice; 4 mm ² ; 13pól.; 4,00 mm ² ; Šedá / zelená – žlutá	www.wago.com/769-113/000-036
	Obj. č.: 769-113/000-037 1vodičová pružinová svorkovnice; 4 mm ² ; 13pól.; 4,00 mm ² ; Zelená – žlutá / šedá	www.wago.com/769-113/000-037
	Obj. č.: 769-113/000-038 1vodičová pružinová svorkovnice; 4 mm ² ; 13pól.; 4,00 mm ² ; Šedá / modrá / zelená – žlutá	www.wago.com/769-113/000-038
	Obj. č.: 769-113/000-039 1vodičová pružinová svorkovnice; 4 mm ² ; 13pól.; 4,00 mm ² ; Zelená – žlutá, modrá, šedá	www.wago.com/769-113/000-039
	Obj. č.: 769-121 2vodičová pružinová svorkovnice; 4 mm ² ; 1pól.; 4,00 mm ² ; Šedá	www.wago.com/769-121
	Obj. č.: 769-121/000-016 2vodičová pružinová svorkovnice; 4 mm ² ; 1pól.; 4,00 mm ² ; Zeleno-žlutá	www.wago.com/769-121/000-016
	Obj. č.: 769-122 2vodičová pružinová svorkovnice; 4 mm ² ; 2pól.; 4,00 mm ² ; Šedá	www.wago.com/769-122
	Obj. č.: 769-123 2vodičová pružinová svorkovnice; 4 mm ² ; 3pól.; 4,00 mm ² ; Šedá	www.wago.com/769-123
	Obj. č.: 769-124 2vodičová pružinová svorkovnice; 4 mm ² ; 4pól.; 4,00 mm ² ; Šedá	www.wago.com/769-124
	Obj. č.: 769-125 2vodičová pružinová svorkovnice; 4 mm ² ; 5pól.; 4,00 mm ² ; Šedá	www.wago.com/769-125
	Obj. č.: 769-126 2vodičová pružinová svorkovnice; 4 mm ² ; 6pól.; 4,00 mm ² ; Šedá	www.wago.com/769-126
	Obj. č.: 769-127 2vodičová pružinová svorkovnice; 4 mm ² ; 7pól.; 4,00 mm ² ; Šedá	www.wago.com/769-127
	Obj. č.: 769-128 2vodičová pružinová svorkovnice; 4 mm ² ; 8pól.; 4,00 mm ² ; Šedá	www.wago.com/769-128
	Obj. č.: 769-129 2vodičová pružinová svorkovnice; 4 mm ² ; 9pól.; 4,00 mm ² ; Šedá	www.wago.com/769-129



Obj. č.: 769-130
2vodičová pružinová svorkovnice; 4 mm²; 10pól.; 4,00 mm²; Šedá

www.wago.com/769-130



Obj. č.: 769-131
2vodičová pružinová svorkovnice; 4 mm²; 11pól.; 4,00 mm²; Šedá

www.wago.com/769-131



Obj. č.: 769-132
2vodičová pružinová svorkovnice; 4 mm²; 12pól.; 4,00 mm²; Šedá

www.wago.com/769-132

ferrule



Obj. č.: 216-101
Dutinka; Objímka na 0,5 mm² / AWG 22; Bez plastového límce; Galvanicky pocínováno

www.wago.com/216-101



Obj. č.: 216-102
Dutinka; Objímka na 0,75 mm² / AWG 20; Bez plastového límce; Galvanicky pocínováno

www.wago.com/216-102



Obj. č.: 216-103
Dutinka; Objímka na 1 mm² / AWG 18; Bez plastového límce; Galvanicky pocínováno

www.wago.com/216-103



Obj. č.: 216-104
Dutinka; Objímka na 1,5 mm² / AWG 16; Bez plastového límce; Galvanicky pocínováno

www.wago.com/216-104



Obj. č.: 216-201
Ferrule; Sleeve for 0.5 mm² / 20 AWG; insulated; electro-tin plated; white

www.wago.com/216-201



Obj. č.: 216-202
Ferrule; Sleeve for 0.75 mm² / 18 AWG; insulated; electro-tin plated; gray

www.wago.com/216-202



Obj. č.: 216-203
Dutinka; Objímka na 1 mm² / AWG 18; S plastovým límcem; Galvanicky pocínováno; Červená

www.wago.com/216-203



Obj. č.: 216-204
Dutinka; Objímka na 1,5 mm² / AWG 16; S plastovým límcem; Galvanicky pocínováno; Černá

www.wago.com/216-204



Obj. č.: 216-206
Dutinka; Objímka na 2,5 mm² / AWG 14; S plastovým límcem; Galvanicky pocínováno; Modrá

www.wago.com/216-206

Strain relief plate



Obj. č.: 769-410
Podložka pro odlehčení tahu; Šedá

www.wago.com/769-410



Obj. č.: 769-414
Podložka pro odlehčení tahu; Šedá

www.wago.com/769-414

tools



Obj. č.: 210-490
Ovládací nástroj

www.wago.com/210-490



Obj. č.: 769-434
Ovládací tlačítko; Volný

www.wago.com/769-434

Insulation stop



Obj. č.: 769-470
Izolační zarážka; 0,08–0,2 mm² „e“ (0,14 mm² „f“); 5 ks/pás; Bílá

www.wago.com/769-470



Obj. č.: 769-471
Izolační zarážka; 0,25–0,5 mm²; 5 ks/pás; Světle šedá

www.wago.com/769-471





Obj. č.: 769-472
Izolační zarážka; 0,75–1 mm²; 5 ks/pás; Tmavě šedá

www.wago.com/769-472

Marking accessories

 **Obj. č.: 2009-145** www.wago.com/2009-145
Mini-WSB Inline; Pro Smart Printer; Na cívce; Flexibilní, 5–5,2 mm; Bez potisku; Možnost naklapnutí; Bílá

 **Obj. č.: 2009-145/000-002** www.wago.com/2009-145/000-002
Mini-WSB Inline; Pro Smart Printer; Na cívce; Flexibilní, 5–5,2 mm; Bez potisku; Možnost naklapnutí; Žlutá

 **Obj. č.: 2009-145/000-005** www.wago.com/2009-145/000-005
Mini-WSB Inline; Pro Smart Printer; Na cívce; Flexibilní, 5–5,2 mm; Bez potisku; Možnost naklapnutí; Červená

 **Obj. č.: 2009-145/000-006** www.wago.com/2009-145/000-006
Mini-WSB Inline; Pro Smart Printer; Na cívce; Flexibilní, 5–5,2 mm; Bez potisku; Možnost naklapnutí; Modrá

 **Obj. č.: 2009-145/000-007** www.wago.com/2009-145/000-007
Mini-WSB Inline; Pro Smart Printer; Na cívce; Flexibilní, 5–5,2 mm; Bez potisku; Možnost naklapnutí; Šedá

 **Obj. č.: 2009-145/000-012** www.wago.com/2009-145/000-012
Mini-WSB Inline; Pro Smart Printer; Na cívce; Flexibilní, 5–5,2 mm; Bez potisku; Možnost naklapnutí; Oranžová

 **Obj. č.: 2009-145/000-023** www.wago.com/2009-145/000-023
Mini-WSB Inline; Pro Smart Printer; Na cívce; Flexibilní, 5–5,2 mm; Bez potisku; Možnost naklapnutí; Zelená

 **Obj. č.: 2009-145/000-024** www.wago.com/2009-145/000-024
Mini-WSB Inline; Pro Smart Printer; Na cívce; Flexibilní, 5–5,2 mm; Bez potisku; Možnost naklapnutí; Fialová

 **Obj. č.: 210-831** www.wago.com/210-831
Popisovací páska; Na cívce; Šířka 2,3 mm; Bez potisku; Samolepicí; Bílá

 **Obj. č.: 210-832** www.wago.com/210-832
Popisovací páska; Na cívce; Šířka 3 mm; Bez potisku; Samolepicí; Bílá

 **Obj. č.: 210-833** www.wago.com/210-833
Popisovací páska; Na cívce; Šířka 6 mm; Bez potisku; Samolepicí; Bílá

 **Obj. č.: 210-834** www.wago.com/210-834
Popisovací páska; Na cívce; Šířka 5 mm; Bez potisku; Samolepicí; Bílá

 **Obj. č.: 248-501** www.wago.com/248-501
Systém rychlého popisování Mini-WSB; Bez potisku; Šířka štítků 5 mm; 10 řad po 10 štítcích na každé kartě

 **Obj. č.: 248-501/000-002** www.wago.com/248-501/000-002
Popisovací karta Mini-WSB; Jako karta; Neflexibilní; Bez potisku; Možnost naklapnutí; Žlutá

 **Obj. č.: 248-501/000-005** www.wago.com/248-501/000-005
Popisovací karta Mini-WSB; Jako karta; Neflexibilní; Bez potisku; Možnost naklapnutí; Červená



Obj. č.: 248-501/000-006
 Popisovací karta Mini-WSB; Jako karta; Neflexibilní; Bez potisku; Možnost naklapnutí; Modrá

www.wago.com/248-501/000-006



Obj. č.: 248-501/000-007
 Popisovací karta Mini-WSB; Jako karta; Neflexibilní; Bez potisku; Možnost naklapnutí; Šedá

www.wago.com/248-501/000-007



Obj. č.: 248-501/000-012
 Popisovací karta Mini-WSB; Jako karta; Neflexibilní; Bez potisku; Možnost naklapnutí; Oranžová

www.wago.com/248-501/000-012



Obj. č.: 248-501/000-017
 Popisovací karta Mini-WSB; Jako karta; Neflexibilní; Bez potisku; Možnost naklapnutí; Světle zelená

www.wago.com/248-501/000-017



Obj. č.: 248-501/000-023
 Popisovací karta Mini-WSB; Jako karta; Neflexibilní; Bez potisku; Možnost naklapnutí; Zelená

www.wago.com/248-501/000-023



Obj. č.: 248-501/000-024
 Popisovací karta Mini-WSB; Jako karta; Neflexibilní; Bez potisku; Možnost naklapnutí; Fialová

www.wago.com/248-501/000-024

Protective Warning Marker



Obj. č.: 280-415
 Výstražný kryt; S černým symbolem blesku; Pro 5 svorek; Žlutá

www.wago.com/280-415

Coding



Obj. č.: 769-435
 Kódovací kolík; Ke kódování pružinových svorkovnic; Pro základní svorky / konektory s pájecími piny; Oranžová

www.wago.com/769-435

Ke stažení

Documentation

Additional Information

Technical explanations	03-Apr-2019	pdf 2,1 MB	Stáhnout
------------------------	-------------	---------------	----------

CAD/CAE-Data

CAD data

2D/3D Models 769-613/005-000	URL	Stáhnout
------------------------------	-----	----------

CAE data

EPLAN Data Portal 769-613/005-000	Stáhnout
-----------------------------------	----------

WSCAD Universe 769-613/005-000	Stáhnout
--------------------------------	----------

Handling Instructions

Assembly

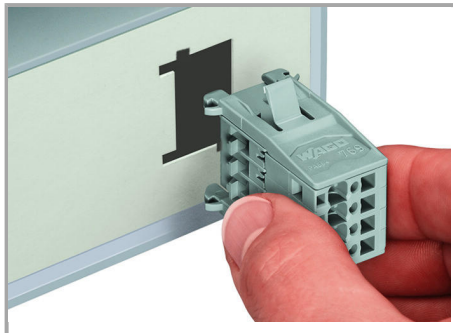

Insert male connector with snap-in flanges (769-604/005-000) into the cutout.

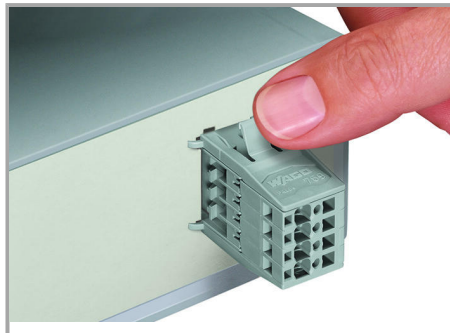

Male connector with snap-in flanges



Snap-in mounting without tools

Snap-in mounting without tools

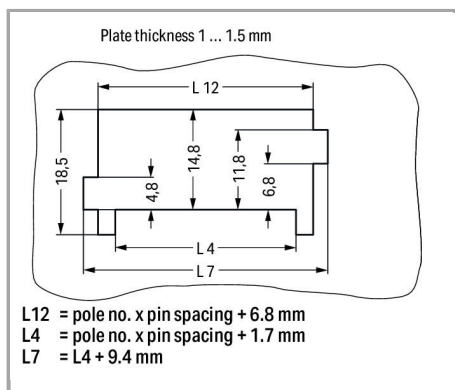

Sheet metal cutout

Male connectors with CAGE CLAMP® connection (769-6xx/005-000) and snap-in flanges

Inserting a conductor

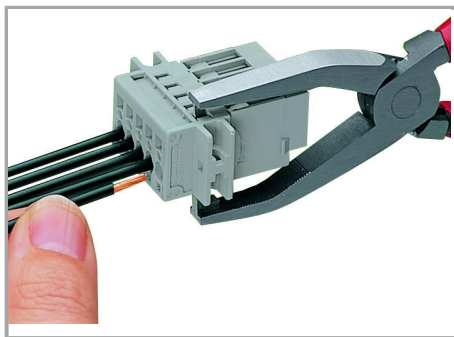

Operating tool

Inserting a conductor via operating tool
(example shows a male connector).

Marking

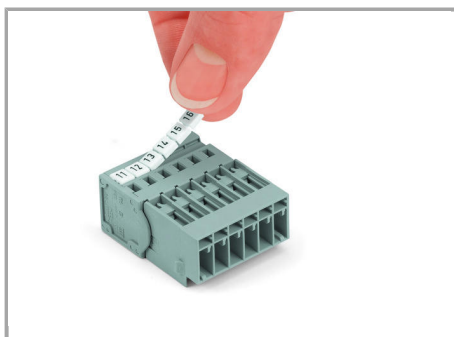

Labeling a male connector with
CAGE CLAMP® connection via Mini-WSB
quick markers.

Produktová rodina

X-COM

[Zobrazit všechny produkty z rodiny](#)

Změny vyhrazeny.