

## Datový list | Objednací číslo: 769-611/002-000

1 vodičový konektor s pájecími piny; Upevňovací příruba; 4 mm<sup>2</sup>; Rozteč 5 mm; 11pól.; 4,00 mm<sup>2</sup>; Šedá



[www.wago.com/769-611/002-000](http://www.wago.com/769-611/002-000)



RoHS  Compliant

BOMcheck.net

Barva: ■

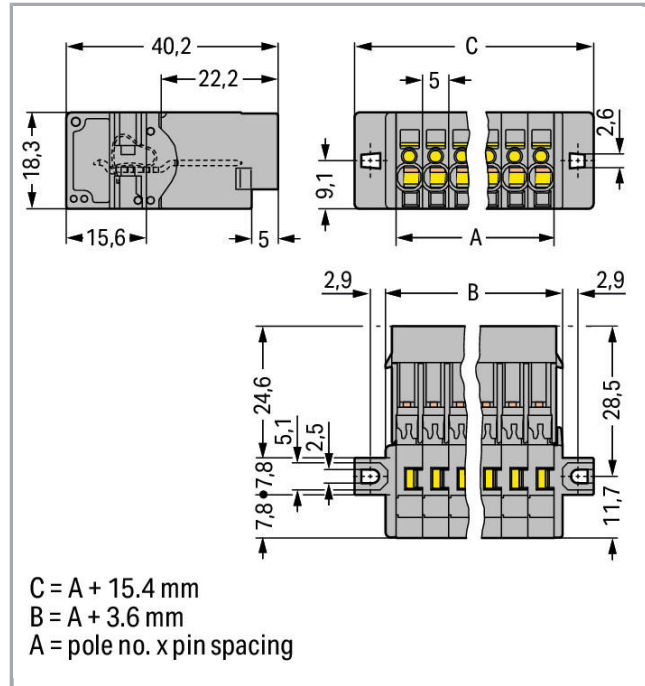

### Data

#### Elektrické parametry

#### Ratings per IEC/EN 60664-1

Návrhové napětí (III / 3)	500 V
Návrhové rázové napětí (III / 3)	6 kV
Jmenovitý proud	32 A
Legenda (návrhové hodnoty)	(III / 3) ≙ kategorie přepětí III / stupeň znečištění 3

### Údaje o připojení

Připojovací technika	CAGE CLAMP®
Způsob ovládání	Ovládací nástroj
Materiály připojitelných vodičů	Měď
Jmenovitý průřez	4 mm <sup>2</sup>
Plný vodič	0,08 ... 4 mm <sup>2</sup> / 28 ... 12 AWG
Jemně laněný vodič	0,08 ... 4 mm <sup>2</sup> / 28 ... 12 AWG
Délka odizolování	8 ... 9 mm / 0.31 ... 0.35 palec



Počet pólů	11
Celkový počet kontaktních míst	11
Celkový počet potenciálů	11
Způsob zapojení	čelní připojení

**Geometrické údaje**

Rozteč	5 mm / 0.197 inch
Šířka	58,6 mm / 2.307 inch
Výška od povrchu	18,3 mm / 0.72 inch
Hloubka	40,2 mm / 1.583 inch

**Mechanické parametry**

Způsob upevnění	Upevňovací příruba
-----------------	--------------------

**Plug connection**

Typ kontaktu (konektor)	Konektor (vidlice) / zástrčka
Typ připojení konektoru	pro vodiče

**Údaje o materiálu**



barva	Šedá
Izolační materiál	Polyamid 66 (PA 66)
Požární zatížení	0.672 MJ
Hmotnost	33.436 g

**Obchodní údaje**

Product Group	18 (X-COM-System)
Druh balení	BOX
Country of origin	PL
GTIN	4044918521673
Customs Tariff No.	85366990990

**Atesty/certifikáty****Specifické atesty jednotlivých států**



Logo	Schválení	Doplňkový text schválení	Název certifikátu
	CCA DEKRA Certification B.V.	EN 61984	2190419.02
	CCA DEKRA Certification B.V.	IEC 61984	NL-47799

	CCA DEKRA Certification B.V.	EN 60947	NTR NL- 7626
	CSA DEKRA Certification B.V.	C22.2 No. 158	1101144
	KEMA/KEUR DEKRA Certification B.V.	EN 60947	2190419.01

#### Atesty pro použití v lodním průmyslu

Logo	Schválení	Doplňkový text schválení	Název certifikátu
	DNV GL Det Norske Veritas, Germanischer Lloyd	-	TAE00001V2

#### Atesty UL

Logo	Schválení	Doplňkový text schválení	Název certifikátu
	UR Underwriters Laboratories Inc.	UL 1059	31.07.2019- E45172
	UR Underwriters Laboratories Inc.	UL 1977	E45171- 20010720

#### Kompatibilní produkty

#### Strain relief plate

	Obj. č.: 769-410 Podložka pro odlehčení tahu; Šedá	<a href="http://www.wago.com/769-410">www.wago.com/769-410</a>
	Obj. č.: 769-414	



Podložka pro odlehčení tahu; Šedá

[www.wago.com/769-414](http://www.wago.com/769-414)

## Protective Warning Marker



**Obj. č.: 280-415**  
Výstražný kryt; S černým symbolem blesku; Pro 5 svorek; Žlutá

[www.wago.com/280-415](http://www.wago.com/280-415)

## ferrule



**Obj. č.: 216-101**  
Dutinka; Objímka na 0,5 mm<sup>2</sup> / AWG 22; Bez plastového límce; Galvanicky pocínováno

[www.wago.com/216-101](http://www.wago.com/216-101)

**Obj. č.: 216-102**  
Dutinka; Objímka na 0,75 mm<sup>2</sup> / AWG 20; Bez plastového límce; Galvanicky pocínováno

[www.wago.com/216-102](http://www.wago.com/216-102)

**Obj. č.: 216-103**  
Dutinka; Objímka na 1 mm<sup>2</sup> / AWG 18; Bez plastového límce; Galvanicky pocínováno

[www.wago.com/216-103](http://www.wago.com/216-103)

**Obj. č.: 216-104**  
Dutinka; Objímka na 1,5 mm<sup>2</sup> / AWG 16; Bez plastového límce; Galvanicky pocínováno

[www.wago.com/216-104](http://www.wago.com/216-104)

**Obj. č.: 216-201**  
Ferrule; Sleeve for 0.5 mm<sup>2</sup> / 20 AWG; insulated; electro-tin plated; white

[www.wago.com/216-201](http://www.wago.com/216-201)

**Obj. č.: 216-202**  
Ferrule; Sleeve for 0.75 mm<sup>2</sup> / 18 AWG; insulated; electro-tin plated; gray

[www.wago.com/216-202](http://www.wago.com/216-202)

**Obj. č.: 216-203**  
Dutinka; Objímka na 1 mm<sup>2</sup> / AWG 18; S plastovým límcem; Galvanicky pocínováno; Červená

[www.wago.com/216-203](http://www.wago.com/216-203)

**Obj. č.: 216-204**  
Dutinka; Objímka na 1,5 mm<sup>2</sup> / AWG 16; S plastovým límcem; Galvanicky pocínováno; Černá

[www.wago.com/216-204](http://www.wago.com/216-204)

**Obj. č.: 216-206**  
Dutinka; Objímka na 2,5 mm<sup>2</sup> / AWG 14; S plastovým límcem; Galvanicky pocínováno; Modrá

[www.wago.com/216-206](http://www.wago.com/216-206)

## Coding



**Obj. č.: 769-435**  
Kódovací kolík; Ke kódování pružinových svorkovnic; Pro základní svorky / konektory s pájecími piny; Oranžová

[www.wago.com/769-435](http://www.wago.com/769-435)

## Marking accessories



**Obj. č.: 2009-145**  
Mini-WSB Inline; Pro Smart Printer; Na cívce; Flexibilní, 5–5,2 mm; Bez potisku; Možnost naklapnutí; Bílá

[www.wago.com/2009-145](http://www.wago.com/2009-145)

**Obj. č.: 2009-145/000-002**  
Mini-WSB Inline; Pro Smart Printer; Na cívce; Flexibilní, 5–5,2 mm; Bez potisku; Možnost naklapnutí; Žlutá /000-002

[www.wago.com/2009-145](http://www.wago.com/2009-145)

**Obj. č.: 2009-145/000-005**  
Mini-WSB Inline; Pro Smart Printer; Na cívce; Flexibilní, 5–5,2 mm; Bez potisku; Možnost naklapnutí; Červená

















[www.wago.com/2009-145](http://www.wago.com/2009-145)  
/000-005

**Obj. č.: 2009-145/000-006**  
Mini-WSB Inline; Pro Smart Printer; Na cívce; Flexibilní, 5–5,2 mm; Bez potisku; Možnost naklapnutí; Modrá

[www.wago.com/2009-145](http://www.wago.com/2009-145)  
/000-006

**Obj. č.: 2009-145/000-007**  
Mini-WSB Inline; Pro Smart Printer; Na cívce; Flexibilní, 5–5,2 mm; Bez potisku; Možnost naklapnutí; Šedá /000-007

[www.wago.com/2009-145](http://www.wago.com/2009-145)

	<b>Obj. č.: 2009-145/000-012</b> Mini-WSB Inline; Pro Smart Printer; Na cívce; Flexibilní, 5–5,2 mm; Bez potisku; Možnost naklapnutí; Oranžová	<a href="http://www.wago.com/2009-145/000-012">www.wago.com/2009-145/000-012</a>
	<b>Obj. č.: 2009-145/000-023</b> Mini-WSB Inline; Pro Smart Printer; Na cívce; Flexibilní, 5–5,2 mm; Bez potisku; Možnost naklapnutí; Zelená	<a href="http://www.wago.com/2009-145/000-023">www.wago.com/2009-145/000-023</a>
	<b>Obj. č.: 2009-145/000-024</b> Mini-WSB Inline; Pro Smart Printer; Na cívce; Flexibilní, 5–5,2 mm; Bez potisku; Možnost naklapnutí; Fialová	<a href="http://www.wago.com/2009-145/000-024">www.wago.com/2009-145/000-024</a>
	<b>Obj. č.: 210-831</b> Popisovací páska; Na cívce; Šířka 2,3 mm; Bez potisku; Samolepicí; Bílá	<a href="http://www.wago.com/210-831">www.wago.com/210-831</a>
	<b>Obj. č.: 210-832</b> Popisovací páska; Na cívce; Šířka 3 mm; Bez potisku; Samolepicí; Bílá	<a href="http://www.wago.com/210-832">www.wago.com/210-832</a>
	<b>Obj. č.: 210-833</b> Popisovací páska; Na cívce; Šířka 6 mm; Bez potisku; Samolepicí; Bílá	<a href="http://www.wago.com/210-833">www.wago.com/210-833</a>
	<b>Obj. č.: 210-834</b> Popisovací páska; Na cívce; Šířka 5 mm; Bez potisku; Samolepicí; Bílá	<a href="http://www.wago.com/210-834">www.wago.com/210-834</a>
	<b>Obj. č.: 248-501</b> Systém rychlého popisování Mini-WSB; Bez potisku; Šířka štítků 5 mm; 10 řad po 10 štítcích na každé kartě	<a href="http://www.wago.com/248-501">www.wago.com/248-501</a>
	<b>Obj. č.: 248-501/000-002</b> Popisovací karta Mini-WSB; Jako karta; Neflexibilní; Bez potisku; Možnost naklapnutí; Žlutá	<a href="http://www.wago.com/248-501/000-002">www.wago.com/248-501/000-002</a>
	<b>Obj. č.: 248-501/000-005</b> Popisovací karta Mini-WSB; Jako karta; Neflexibilní; Bez potisku; Možnost naklapnutí; Červená	<a href="http://www.wago.com/248-501/000-005">www.wago.com/248-501/000-005</a>
	<b>Obj. č.: 248-501/000-006</b> Popisovací karta Mini-WSB; Jako karta; Neflexibilní; Bez potisku; Možnost naklapnutí; Modrá	<a href="http://www.wago.com/248-501/000-006">www.wago.com/248-501/000-006</a>
	<b>Obj. č.: 248-501/000-007</b> Popisovací karta Mini-WSB; Jako karta; Neflexibilní; Bez potisku; Možnost naklapnutí; Šedá	<a href="http://www.wago.com/248-501/000-007">www.wago.com/248-501/000-007</a>
	<b>Obj. č.: 248-501/000-012</b> Popisovací karta Mini-WSB; Jako karta; Neflexibilní; Bez potisku; Možnost naklapnutí; Oranžová	<a href="http://www.wago.com/248-501/000-012">www.wago.com/248-501/000-012</a>
	<b>Obj. č.: 248-501/000-017</b> Popisovací karta Mini-WSB; Jako karta; Neflexibilní; Bez potisku; Možnost naklapnutí; Světle zelená	<a href="http://www.wago.com/248-501/000-017">www.wago.com/248-501/000-017</a>
	<b>Obj. č.: 248-501/000-023</b> Popisovací karta Mini-WSB; Jako karta; Neflexibilní; Bez potisku; Možnost naklapnutí; Zelená	<a href="http://www.wago.com/248-501/000-023">www.wago.com/248-501/000-023</a>
	<b>Obj. č.: 248-501/000-024</b> Popisovací karta Mini-WSB; Jako karta; Neflexibilní; Bez potisku; Možnost naklapnutí; Fialová	<a href="http://www.wago.com/248-501/000-024">www.wago.com/248-501/000-024</a>

## assembling



**Obj. č.: 769-499**  
Upevňovací šroub M2,5 × 16; a šestihranná matice M2,5

[www.wago.com/769-499](http://www.wago.com/769-499)

## Female plug



**Obj. č.: 769-101**  
1vodičová pružinová svorkovnice; 4 mm<sup>2</sup>; 1pól.; 4,00 mm<sup>2</sup>; Šedá

[www.wago.com/769-101](http://www.wago.com/769-101)



**Obj. č.: 769-101/000-016**  
1vodičová pružinová svorkovnice; 4 mm<sup>2</sup>; 1pól.; 4,00 mm<sup>2</sup>; Zeleno-žlutá

[www.wago.com/769-101/000-016](http://www.wago.com/769-101/000-016)



**Obj. č.: 769-102**  
1vodičová pružinová svorkovnice; 4 mm<sup>2</sup>; 2pól.; 4,00 mm<sup>2</sup>; Šedá

[www.wago.com/769-102](http://www.wago.com/769-102)



**Obj. č.: 769-102/000-036**  
1vodičová pružinová svorkovnice; 4 mm<sup>2</sup>; 2pól.; 4,00 mm<sup>2</sup>; Šedá / zelená – žlutá

[www.wago.com/769-102/000-036](http://www.wago.com/769-102/000-036)



**Obj. č.: 769-102/000-037**  
1vodičová pružinová svorkovnice; 4 mm<sup>2</sup>; 2pól.; 4,00 mm<sup>2</sup>; Zelená – žlutá / šedá

[www.wago.com/769-102/000-037](http://www.wago.com/769-102/000-037)



**Obj. č.: 769-103**  
1vodičová pružinová svorkovnice; 4 mm<sup>2</sup>; 3pól.; 4,00 mm<sup>2</sup>; Šedá

[www.wago.com/769-103](http://www.wago.com/769-103)



**Obj. č.: 769-103/000-036**  
1vodičová pružinová svorkovnice; 4 mm<sup>2</sup>; 3pól.; 4,00 mm<sup>2</sup>; Šedá / zelená – žlutá

[www.wago.com/769-103/000-036](http://www.wago.com/769-103/000-036)



**Obj. č.: 769-103/000-037**  
1vodičová pružinová svorkovnice; 4 mm<sup>2</sup>; 3pól.; 4,00 mm<sup>2</sup>; Zelená – žlutá / šedá

[www.wago.com/769-103/000-037](http://www.wago.com/769-103/000-037)



**Obj. č.: 769-103/000-038**  
1vodičová pružinová svorkovnice; 4 mm<sup>2</sup>; 3pól.; 4,00 mm<sup>2</sup>; Šedá / modrá / zelená – žlutá

[www.wago.com/769-103/000-038](http://www.wago.com/769-103/000-038)



**Obj. č.: 769-103/000-039**  
1vodičová pružinová svorkovnice; 4 mm<sup>2</sup>; 3pól.; 4,00 mm<sup>2</sup>; Zelená – žlutá, modrá, šedá

[www.wago.com/769-103/000-039](http://www.wago.com/769-103/000-039)



**Obj. č.: 769-104**  
1vodičová pružinová svorkovnice; 4 mm<sup>2</sup>; 4pól.; 4,00 mm<sup>2</sup>; Šedá

[www.wago.com/769-104](http://www.wago.com/769-104)



**Obj. č.: 769-104/000-036**  
1vodičová pružinová svorkovnice; 4 mm<sup>2</sup>; 4pól.; 4,00 mm<sup>2</sup>; Šedá / zelená – žlutá

[www.wago.com/769-104/000-036](http://www.wago.com/769-104/000-036)

















**Obj. č.: 769-104/000-037**  
1vodičová pružinová svorkovnice; 4 mm<sup>2</sup>; 4pól.; 4,00 mm<sup>2</sup>; Zelená – žlutá / šedá

[www.wago.com/769-104/000-037](http://www.wago.com/769-104/000-037)

















**Obj. č.: 769-104/000-038**  
1vodičová pružinová svorkovnice; 4 mm<sup>2</sup>; 4pól.; 4,00 mm<sup>2</sup>; Šedá / modrá / zelená – žlutá

















[www.wago.com/769-104/000-038](http://www.wago.com/769-104/000-038)

	<b>Obj. č.: 769-104/000-039</b> 1vodičová pružinová svorkovnice; 4 mm <sup>2</sup> ; 4pól.; 4,00 mm <sup>2</sup> ; Zelená – žlutá, modrá, šedá	<a href="http://www.wago.com/769-104/000-039">www.wago.com/769-104/000-039</a>
	<b>Obj. č.: 769-105</b> 1vodičová pružinová svorkovnice; 4 mm <sup>2</sup> ; 5pól.; 4,00 mm <sup>2</sup> ; Šedá	<a href="http://www.wago.com/769-105">www.wago.com/769-105</a>
	<b>Obj. č.: 769-105/000-036</b> 1vodičová pružinová svorkovnice; 4 mm <sup>2</sup> ; 5pól.; 4,00 mm <sup>2</sup> ; Šedá / zelená – žlutá	<a href="http://www.wago.com/769-105/000-036">www.wago.com/769-105/000-036</a>
	<b>Obj. č.: 769-105/000-037</b> 1vodičová pružinová svorkovnice; 4 mm <sup>2</sup> ; 5pól.; 4,00 mm <sup>2</sup> ; Zelená – žlutá / šedá	<a href="http://www.wago.com/769-105/000-037">www.wago.com/769-105/000-037</a>
	<b>Obj. č.: 769-105/000-038</b> 1vodičová pružinová svorkovnice; 4 mm <sup>2</sup> ; 5pól.; 4,00 mm <sup>2</sup> ; Šedá / modrá / zelená – žlutá	<a href="http://www.wago.com/769-105/000-038">www.wago.com/769-105/000-038</a>
	<b>Obj. č.: 769-105/000-039</b> 1vodičová pružinová svorkovnice; 4 mm <sup>2</sup> ; 5pól.; 4,00 mm <sup>2</sup> ; Zelená – žlutá, modrá, šedá	<a href="http://www.wago.com/769-105/000-039">www.wago.com/769-105/000-039</a>
	<b>Obj. č.: 769-106</b> 1vodičová pružinová svorkovnice; 4 mm <sup>2</sup> ; 6pól.; 4,00 mm <sup>2</sup> ; Šedá	<a href="http://www.wago.com/769-106">www.wago.com/769-106</a>
	<b>Obj. č.: 769-106/000-006</b> 1vodičová pružinová svorkovnice; 4 mm <sup>2</sup> ; 6pól.; 4,00 mm <sup>2</sup> ; Modrá	<a href="http://www.wago.com/769-106/000-006">www.wago.com/769-106/000-006</a>
	<b>Obj. č.: 769-106/000-036</b> 1vodičová pružinová svorkovnice; 4 mm <sup>2</sup> ; 6pól.; 4,00 mm <sup>2</sup> ; Šedá / zelená – žlutá	<a href="http://www.wago.com/769-106/000-036">www.wago.com/769-106/000-036</a>
	<b>Obj. č.: 769-106/000-037</b> 1vodičová pružinová svorkovnice; 4 mm <sup>2</sup> ; 6pól.; 4,00 mm <sup>2</sup> ; Zelená – žlutá / šedá	<a href="http://www.wago.com/769-106/000-037">www.wago.com/769-106/000-037</a>
	<b>Obj. č.: 769-106/000-038</b> 1vodičová pružinová svorkovnice; 4 mm <sup>2</sup> ; 6pól.; 4,00 mm <sup>2</sup> ; Šedá / modrá / zelená – žlutá	<a href="http://www.wago.com/769-106/000-038">www.wago.com/769-106/000-038</a>
	<b>Obj. č.: 769-106/000-039</b> 1vodičová pružinová svorkovnice; 4 mm <sup>2</sup> ; 6pól.; 4,00 mm <sup>2</sup> ; Zelená – žlutá, modrá, šedá	<a href="http://www.wago.com/769-106/000-039">www.wago.com/769-106/000-039</a>
	<b>Obj. č.: 769-107</b> 1vodičová pružinová svorkovnice; 4 mm <sup>2</sup> ; 7pól.; 4,00 mm <sup>2</sup> ; Šedá	<a href="http://www.wago.com/769-107">www.wago.com/769-107</a>
	<b>Obj. č.: 769-107/000-036</b> 1vodičová pružinová svorkovnice; 4 mm <sup>2</sup> ; 7pól.; 4,00 mm <sup>2</sup> ; Šedá / zelená – žlutá	<a href="http://www.wago.com/769-107/000-036">www.wago.com/769-107/000-036</a>
	<b>Obj. č.: 769-107/000-037</b> 1vodičová pružinová svorkovnice; 4 mm <sup>2</sup> ; 7pól.; 4,00 mm <sup>2</sup> ; Zelená – žlutá / šedá	<a href="http://www.wago.com/769-107/000-037">www.wago.com/769-107/000-037</a>
	<b>Obj. č.: 769-107/000-038</b> 1vodičová pružinová svorkovnice; 4 mm <sup>2</sup> ; 7pól.; 4,00 mm <sup>2</sup> ; Šedá / modrá / zelená – žlutá	<a href="http://www.wago.com/769-107/000-038">www.wago.com/769-107/000-038</a>



	<b>Obj. č.: 769-107/000-039</b> 1vodičová pružinová svorkovnice; 4 mm <sup>2</sup> ; 7pól.; 4,00 mm <sup>2</sup> ; Zelená – žlutá, modrá, šedá	<a href="http://www.wago.com/769-107/000-039">www.wago.com/769-107/000-039</a>
	<b>Obj. č.: 769-108</b> 1vodičová pružinová svorkovnice; 4 mm <sup>2</sup> ; 8pól.; 4,00 mm <sup>2</sup> ; Šedá	<a href="http://www.wago.com/769-108">www.wago.com/769-108</a>
	<b>Obj. č.: 769-108/000-036</b> 1vodičová pružinová svorkovnice; 4 mm <sup>2</sup> ; 8pól.; 4,00 mm <sup>2</sup> ; Šedá / zelená – žlutá	<a href="http://www.wago.com/769-108/000-036">www.wago.com/769-108/000-036</a>
	<b>Obj. č.: 769-108/000-037</b> 1vodičová pružinová svorkovnice; 4 mm <sup>2</sup> ; 8pól.; 4,00 mm <sup>2</sup> ; Zelená – žlutá / šedá	<a href="http://www.wago.com/769-108/000-037">www.wago.com/769-108/000-037</a>
	<b>Obj. č.: 769-108/000-038</b> 1vodičová pružinová svorkovnice; 4 mm <sup>2</sup> ; 8pól.; 4,00 mm <sup>2</sup> ; Šedá / modrá / zelená – žlutá	<a href="http://www.wago.com/769-108/000-038">www.wago.com/769-108/000-038</a>
	<b>Obj. č.: 769-108/000-039</b> 1vodičová pružinová svorkovnice; 4 mm <sup>2</sup> ; 8pól.; 4,00 mm <sup>2</sup> ; Zelená – žlutá, modrá, šedá	<a href="http://www.wago.com/769-108/000-039">www.wago.com/769-108/000-039</a>
	<b>Obj. č.: 769-109</b> 1vodičová pružinová svorkovnice; 4 mm <sup>2</sup> ; 9pól.; 4,00 mm <sup>2</sup> ; Šedá	<a href="http://www.wago.com/769-109">www.wago.com/769-109</a>
	<b>Obj. č.: 769-109/000-036</b> 1vodičová pružinová svorkovnice; 4 mm <sup>2</sup> ; 9pól.; 4,00 mm <sup>2</sup> ; Šedá / zelená – žlutá	<a href="http://www.wago.com/769-109/000-036">www.wago.com/769-109/000-036</a>
	<b>Obj. č.: 769-109/000-037</b> 1vodičová pružinová svorkovnice; 4 mm <sup>2</sup> ; 9pól.; 4,00 mm <sup>2</sup> ; Zelená – žlutá / šedá	<a href="http://www.wago.com/769-109/000-037">www.wago.com/769-109/000-037</a>
	<b>Obj. č.: 769-109/000-038</b> 1vodičová pružinová svorkovnice; 4 mm <sup>2</sup> ; 9pól.; 4,00 mm <sup>2</sup> ; Šedá / modrá / zelená – žlutá	<a href="http://www.wago.com/769-109/000-038">www.wago.com/769-109/000-038</a>
	<b>Obj. č.: 769-109/000-039</b> 1vodičová pružinová svorkovnice; 4 mm <sup>2</sup> ; 9pól.; 4,00 mm <sup>2</sup> ; Zelená – žlutá, modrá, šedá	<a href="http://www.wago.com/769-109/000-039">www.wago.com/769-109/000-039</a>
	<b>Obj. č.: 769-110</b> 1vodičová pružinová svorkovnice; 4 mm <sup>2</sup> ; 10pól.; 4,00 mm <sup>2</sup> ; Šedá	<a href="http://www.wago.com/769-110">www.wago.com/769-110</a>
	<b>Obj. č.: 769-110/000-036</b> 1vodičová pružinová svorkovnice; 4 mm <sup>2</sup> ; 10pól.; 4,00 mm <sup>2</sup> ; Šedá / zelená – žlutá	<a href="http://www.wago.com/769-110/000-036">www.wago.com/769-110/000-036</a>
	<b>Obj. č.: 769-110/000-037</b> 1vodičová pružinová svorkovnice; 4 mm <sup>2</sup> ; 10pól.; 4,00 mm <sup>2</sup> ; Zelená – žlutá / šedá	<a href="http://www.wago.com/769-110/000-037">www.wago.com/769-110/000-037</a>
	<b>Obj. č.: 769-110/000-038</b> 1vodičová pružinová svorkovnice; 4 mm <sup>2</sup> ; 10pól.; 4,00 mm <sup>2</sup> ; Šedá / modrá / zelená – žlutá	<a href="http://www.wago.com/769-110/000-038">www.wago.com/769-110/000-038</a>



	<b>Obj. č.: 769-110/000-039</b> 1vodičová pružinová svorkovnice; 4 mm <sup>2</sup> ; 10pól.; 4,00 mm <sup>2</sup> ; Zelená – žlutá, modrá, šedá	<a href="http://www.wago.com/769-110/000-039">www.wago.com/769-110/000-039</a>
	<b>Obj. č.: 769-111/000-036</b> 1vodičová pružinová svorkovnice; 4 mm <sup>2</sup> ; 11pól.; 4,00 mm <sup>2</sup> ; Šedá / zelená – žlutá	<a href="http://www.wago.com/769-111/000-036">www.wago.com/769-111/000-036</a>
	<b>Obj. č.: 769-111/000-037</b> 1vodičová pružinová svorkovnice; 4 mm <sup>2</sup> ; 11pól.; 4,00 mm <sup>2</sup> ; Zelená – žlutá / šedá	<a href="http://www.wago.com/769-111/000-037">www.wago.com/769-111/000-037</a>
	<b>Obj. č.: 769-111/000-038</b> 1vodičová pružinová svorkovnice; 4 mm <sup>2</sup> ; 11pól.; 4,00 mm <sup>2</sup> ; Šedá / modrá / zelená – žlutá	<a href="http://www.wago.com/769-111/000-038">www.wago.com/769-111/000-038</a>
	<b>Obj. č.: 769-111/000-039</b> 1vodičová pružinová svorkovnice; 4 mm <sup>2</sup> ; 11pól.; 4,00 mm <sup>2</sup> ; Zelená – žlutá, modrá, šedá	<a href="http://www.wago.com/769-111/000-039">www.wago.com/769-111/000-039</a>
	<b>Obj. č.: 769-121</b> 2vodičová pružinová svorkovnice; 4 mm <sup>2</sup> ; 1pól.; 4,00 mm <sup>2</sup> ; Šedá	<a href="http://www.wago.com/769-121">www.wago.com/769-121</a>
	<b>Obj. č.: 769-122</b> 2vodičová pružinová svorkovnice; 4 mm <sup>2</sup> ; 2pól.; 4,00 mm <sup>2</sup> ; Šedá	<a href="http://www.wago.com/769-122">www.wago.com/769-122</a>
	<b>Obj. č.: 769-123</b> 2vodičová pružinová svorkovnice; 4 mm <sup>2</sup> ; 3pól.; 4,00 mm <sup>2</sup> ; Šedá	<a href="http://www.wago.com/769-123">www.wago.com/769-123</a>
	<b>Obj. č.: 769-124</b> 2vodičová pružinová svorkovnice; 4 mm <sup>2</sup> ; 4pól.; 4,00 mm <sup>2</sup> ; Šedá	<a href="http://www.wago.com/769-124">www.wago.com/769-124</a>
	<b>Obj. č.: 769-125</b> 2vodičová pružinová svorkovnice; 4 mm <sup>2</sup> ; 5pól.; 4,00 mm <sup>2</sup> ; Šedá	<a href="http://www.wago.com/769-125">www.wago.com/769-125</a>
	<b>Obj. č.: 769-126</b> 2vodičová pružinová svorkovnice; 4 mm <sup>2</sup> ; 6pól.; 4,00 mm <sup>2</sup> ; Šedá	<a href="http://www.wago.com/769-126">www.wago.com/769-126</a>
	<b>Obj. č.: 769-127</b> 2vodičová pružinová svorkovnice; 4 mm <sup>2</sup> ; 7pól.; 4,00 mm <sup>2</sup> ; Šedá	<a href="http://www.wago.com/769-127">www.wago.com/769-127</a>
	<b>Obj. č.: 769-128</b> 2vodičová pružinová svorkovnice; 4 mm <sup>2</sup> ; 8pól.; 4,00 mm <sup>2</sup> ; Šedá	<a href="http://www.wago.com/769-128">www.wago.com/769-128</a>
	<b>Obj. č.: 769-129</b> 2vodičová pružinová svorkovnice; 4 mm <sup>2</sup> ; 9pól.; 4,00 mm <sup>2</sup> ; Šedá	<a href="http://www.wago.com/769-129">www.wago.com/769-129</a>
	<b>Obj. č.: 769-130</b> 2vodičová pružinová svorkovnice; 4 mm <sup>2</sup> ; 10pól.; 4,00 mm <sup>2</sup> ; Šedá	<a href="http://www.wago.com/769-130">www.wago.com/769-130</a>
<b>Insulation stop</b>		
	<b>Obj. č.: 769-470</b> Izolační zarážka; 0,08–0,2 mm <sup>2</sup> „e“ (0,14 mm <sup>2</sup> „f“); 5 ks/pás; Bílá	<a href="http://www.wago.com/769-470">www.wago.com/769-470</a>
	<b>Obj. č.: 769-471</b> Izolační zarážka; 0,25–0,5 mm <sup>2</sup> ; 5 ks/pás; Světle šedá	<a href="http://www.wago.com/769-471">www.wago.com/769-471</a>



Obj. č.: 769-472  
Izolační zarážka; 0,75–1 mm<sup>2</sup>; 5 ks/pás; Tmavě šedá

[www.wago.com/769-472](http://www.wago.com/769-472)

tools



Obj. č.: 210-490  
Ovládací nástroj

[www.wago.com/210-490](http://www.wago.com/210-490)



Obj. č.: 769-434  
Ovládací tlačítko; Volný

[www.wago.com/769-434](http://www.wago.com/769-434)

Ke stažení

Documentation

Additional Information

Technical explanations	03-Apr-2019	pdf 2,1 MB	Stáhnout
------------------------	-------------	---------------	----------

CAD/CAE-Data

CAD data

2D/3D Models 769-611/002-000	URL	Stáhnout
------------------------------	-----	----------

CAE data

EPLAN Data Portal 769-611/002-000	Stáhnout
-----------------------------------	----------

WSCAD Universe 769-611/002-000	Stáhnout
--------------------------------	----------

Handling Instructions

Assembly

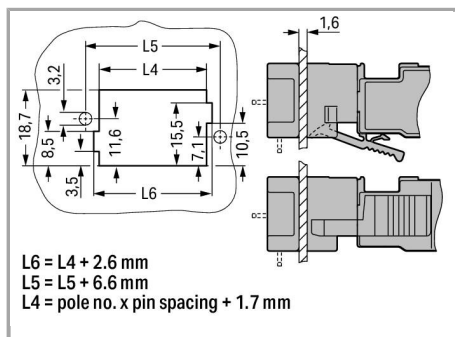

Cutout

Male headers with solder pins and fixing flanges

Inserting a conductor

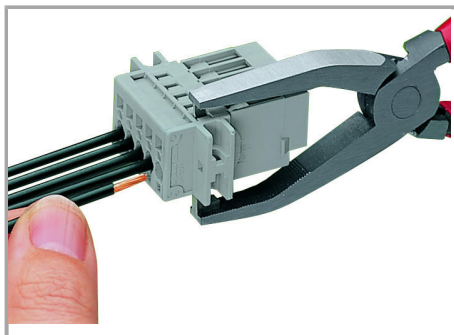

Operating tool

Inserting a conductor via operating tool  
(example shows a male connector).

Application

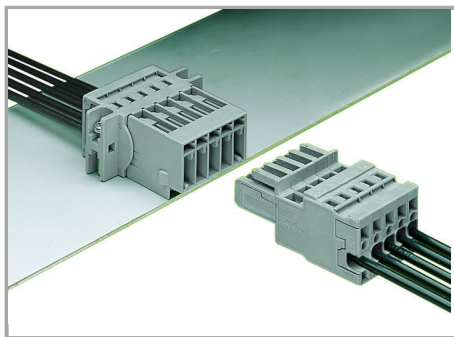

Male connector with CAGE CLAMP® and mounting flanges

1-connector female plug, straight

#### Marking

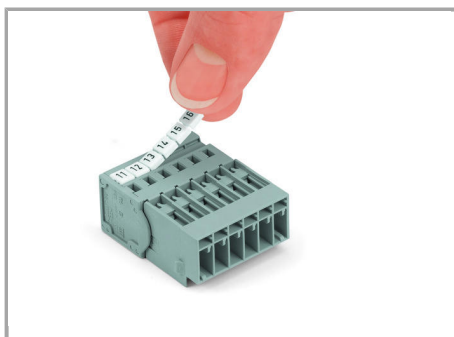

Labeling a male connector with CAGE CLAMP® connection via Mini-WSB quick markers.

#### Produktová rodina

**X-COM**

[Zobrazit všechny produkty z rodiny](#)

Změny vyhrazeny.