

Datový list | Objednací číslo: 769-610/005-000

1 vodičový konektor s pájecími piny; Zajišťovací příruba; 4 mm²; Rozteč 5 mm; 10pól.; 4,00 mm²; Šedá

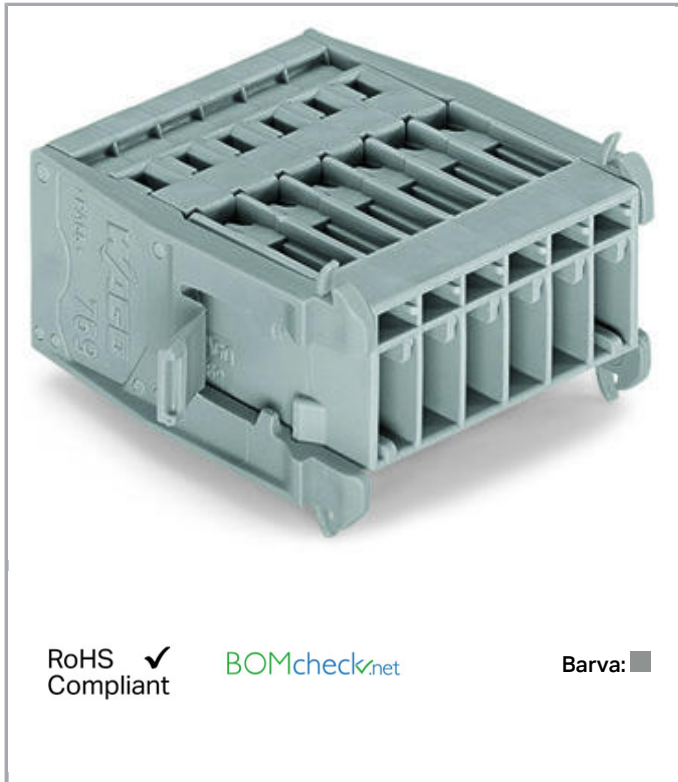

www.wago.com/769-610/005-000



RoHS Compliant

BOMcheck.net

Barva: ■

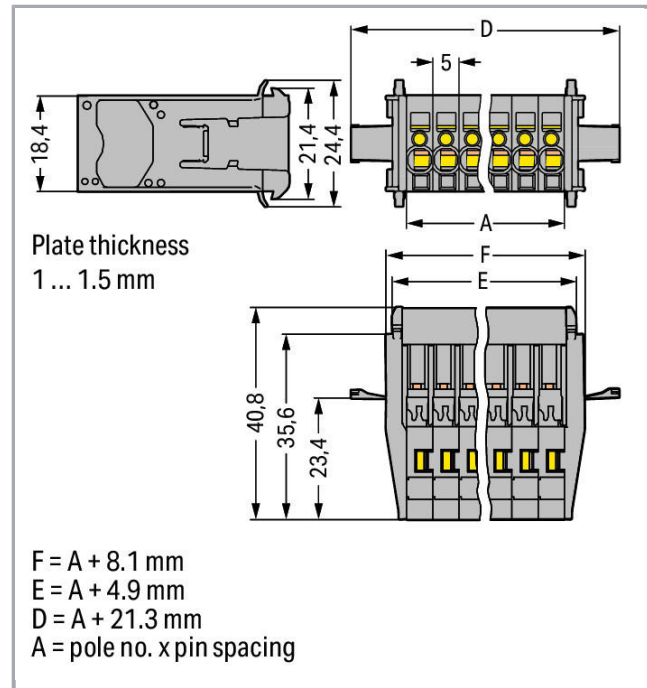

Data

Elektrické parametry

Ratings per IEC/EN 60664-1

Návrhové napětí (III / 3)	500 V
Návrhové rázové napětí (III / 3)	6 kV
Jmenovitý proud	32 A
Legenda (návrhové hodnoty)	(III / 3) ≙ kategorie přepětí III / stupeň znečištění 3

Údaje o připojení

Připojovací technika	CAGE CLAMP®
Způsob ovládání	Ovládací nástroj
Materiály připojitelných vodičů	Měď
Jmenovitý průřez	4 mm ²
Plný vodič	0,08 ... 4 mm ² / 28 ... 12 AWG
Jemně laněný vodič	0,08 ... 4 mm ² / 28 ... 12 AWG
Délka odizolování	8 ... 9 mm / 0.31 ... 0.35 palec



Počet pólů	10
Celkový počet kontaktních míst	10
Celkový počet potenciálů	10
Způsob zapojení	čelní připojení

Geometrické údaje

Rozteč	5 mm / 0.197 inch
Šířka	71,3 mm / 2.807 inch
Výška	24,4 mm / 0.961 inch
Hloubka	40,8 mm / 1.606 inch

Mechanické parametry

Způsob upevnění	Snap-in
-----------------	---------

Plug connection

Typ kontaktu (konektor)	Konektor (vidlice) / zástrčka
Typ připojení konektoru	pro vodiče

Údaje o materiálu

barva	Šedá
Izolační materiál	Polyamid 66 (PA 66)
Požární zatížení	0.633 MJ
Hmotnost	31.12 g

Obchodní údaje

Product Group	18 (X-COM-System)
Druh balení	BOX
Country of origin	PL
GTIN	4044918840965
Customs Tariff No.	85366990990

Atesty/certifikáty

Specifické atesty jednotlivých států

Logo	Schválení	Doplňkový text schválení	Název certifikátu
	CCA DEKRA Certification B.V.	EN 61984	2190419.02
	CCA	IEC 61984	NL-47799



DEKRA Certification B.V.

CSA
DEKRA Certification B.V.

C22.2 No. 158



1101144

Atesty UL





Logo	Schválení	Doplňkový text schválení	Název certifikátu
	UR Underwriters Laboratories Inc.	UL 1977	E45171- 20010720
	UR Underwriters Laboratories Inc.	UL 1059	31.07.2019- E45172

















Kompatibilní produkty

Insulation stop

	Obj. č.: 769-470 Izolační zarážka; 0,08–0,2 mm ² „e“ (0,14 mm ² „f“); 5 ks/pás; Bílá	www.wago.com/769-470
	Obj. č.: 769-471 Izolační zarážka; 0,25–0,5 mm ² ; 5 ks/pás; Světle šedá	www.wago.com/769-471
	Obj. č.: 769-472 Izolační zarážka; 0,75–1 mm ² ; 5 ks/pás; Tmavě šedá	www.wago.com/769-472

ferrule

	Obj. č.: 216-101 Dutinka; Objímka na 0,5 mm ² / AWG 22; Bez plastového límce; Galvanicky pocínováno	www.wago.com/216-101
	Obj. č.: 216-102 Dutinka; Objímka na 0,75 mm ² / AWG 20; Bez plastového límce; Galvanicky pocínováno	www.wago.com/216-102
	Obj. č.: 216-103 Dutinka; Objímka na 1 mm ² / AWG 18; Bez plastového límce; Galvanicky pocínováno	www.wago.com/216-103
	Obj. č.: 216-104 Dutinka; Objímka na 1,5 mm ² / AWG 16; Bez plastového límce; Galvanicky pocínováno	www.wago.com/216-104

	Obj. č.: 216-201 Ferrule; Sleeve for 0.5 mm ² / 20 AWG; insulated; electro-tin plated; white	www.wago.com/216-201
	Obj. č.: 216-202 Ferrule; Sleeve for 0.75 mm ² / 18 AWG; insulated; electro-tin plated; gray	www.wago.com/216-202
	Obj. č.: 216-203 Dutinka; Objímka na 1 mm ² / AWG 18; S plastovým límcem; Galvanicky pocínováno; Červená	www.wago.com/216-203
	Obj. č.: 216-204 Dutinka; Objímka na 1,5 mm ² / AWG 16; S plastovým límcem; Galvanicky pocínováno; Černá	www.wago.com/216-204
	Obj. č.: 216-206 Dutinka; Objímka na 2,5 mm ² / AWG 14; S plastovým límcem; Galvanicky pocínováno; Modrá	www.wago.com/216-206
Marking accessories		
	Obj. č.: 2009-145 Mini-WSB Inline; Pro Smart Printer; Na cívce; Flexibilní, 5–5,2 mm; Bez potisku; Možnost naklapnutí; Bílá	www.wago.com/2009-145
	Obj. č.: 2009-145/000-002 Mini-WSB Inline; Pro Smart Printer; Na cívce; Flexibilní, 5–5,2 mm; Bez potisku; Možnost naklapnutí; Žlutá /000-002	www.wago.com/2009-145/000-002
	Obj. č.: 2009-145/000-005 Mini-WSB Inline; Pro Smart Printer; Na cívce; Flexibilní, 5–5,2 mm; Bez potisku; Možnost naklapnutí; Červená	www.wago.com/2009-145/000-005
	Obj. č.: 2009-145/000-006 Mini-WSB Inline; Pro Smart Printer; Na cívce; Flexibilní, 5–5,2 mm; Bez potisku; Možnost naklapnutí; Modrá	www.wago.com/2009-145/000-006
	Obj. č.: 2009-145/000-007 Mini-WSB Inline; Pro Smart Printer; Na cívce; Flexibilní, 5–5,2 mm; Bez potisku; Možnost naklapnutí; Šedá /000-007	www.wago.com/2009-145/000-007
	Obj. č.: 2009-145/000-012 Mini-WSB Inline; Pro Smart Printer; Na cívce; Flexibilní, 5–5,2 mm; Bez potisku; Možnost naklapnutí; Oranžová	www.wago.com/2009-145/000-012
	Obj. č.: 2009-145/000-023 Mini-WSB Inline; Pro Smart Printer; Na cívce; Flexibilní, 5–5,2 mm; Bez potisku; Možnost naklapnutí; Zelená	www.wago.com/2009-145/000-023
	Obj. č.: 2009-145/000-024 Mini-WSB Inline; Pro Smart Printer; Na cívce; Flexibilní, 5–5,2 mm; Bez potisku; Možnost naklapnutí; Fialová	www.wago.com/2009-145/000-024
	Obj. č.: 210-831 Popisovací páska; Na cívce; Šířka 2,3 mm; Bez potisku; Samolepicí; Bílá	www.wago.com/210-831
	Obj. č.: 210-832 Popisovací páska; Na cívce; Šířka 3 mm; Bez potisku; Samolepicí; Bílá	www.wago.com/210-832
	Obj. č.: 210-833 Popisovací páska; Na cívce; Šířka 6 mm; Bez potisku; Samolepicí; Bílá	www.wago.com/210-833
	Obj. č.: 210-834 Popisovací páska; Na cívce; Šířka 5 mm; Bez potisku; Samolepicí; Bílá	www.wago.com/210-834



Obj. č.: 248-501

Systém rychlého popisování Mini-WSB; Bez potisku; Šířka štítků 5 mm; 10 řad po 10 štítků na každé kartě

www.wago.com/248-501



Obj. č.: 248-501/000-002

Popisovací karta Mini-WSB; Jako karta; Neflexibilní; Bez potisku; Možnost naklapnutí; Žlutá

www.wago.com/248-501/000-002



Obj. č.: 248-501/000-005

Popisovací karta Mini-WSB; Jako karta; Neflexibilní; Bez potisku; Možnost naklapnutí; Červená

www.wago.com/248-501/000-005



Obj. č.: 248-501/000-006

Popisovací karta Mini-WSB; Jako karta; Neflexibilní; Bez potisku; Možnost naklapnutí; Modrá

www.wago.com/248-501/000-006



Obj. č.: 248-501/000-007

Popisovací karta Mini-WSB; Jako karta; Neflexibilní; Bez potisku; Možnost naklapnutí; Šedá

www.wago.com/248-501/000-007



Obj. č.: 248-501/000-012

Popisovací karta Mini-WSB; Jako karta; Neflexibilní; Bez potisku; Možnost naklapnutí; Oranžová

www.wago.com/248-501/000-012



Obj. č.: 248-501/000-017

Popisovací karta Mini-WSB; Jako karta; Neflexibilní; Bez potisku; Možnost naklapnutí; Světle zelená

www.wago.com/248-501/000-017



Obj. č.: 248-501/000-023

Popisovací karta Mini-WSB; Jako karta; Neflexibilní; Bez potisku; Možnost naklapnutí; Zelená

www.wago.com/248-501/000-023



Obj. č.: 248-501/000-024

Popisovací karta Mini-WSB; Jako karta; Neflexibilní; Bez potisku; Možnost naklapnutí; Fialová

www.wago.com/248-501/000-024

Female plug



Obj. č.: 769-101

1 vodičová pružinová svorkovnice; 4 mm²; 1pól.; 4,00 mm²; Šedá

www.wago.com/769-101



Obj. č.: 769-101/000-016

1 vodičová pružinová svorkovnice; 4 mm²; 1pól.; 4,00 mm²; Zeleno-žlutá

www.wago.com/769-101/000-016



Obj. č.: 769-102

1 vodičová pružinová svorkovnice; 4 mm²; 2pól.; 4,00 mm²; Šedá

www.wago.com/769-102



Obj. č.: 769-102/000-036

1 vodičová pružinová svorkovnice; 4 mm²; 2pól.; 4,00 mm²; Šedá / zelená – žlutá

www.wago.com/769-102/000-036



Obj. č.: 769-102/000-037

1 vodičová pružinová svorkovnice; 4 mm²; 2pól.; 4,00 mm²; Zelená – žlutá / šedá















www.wago.com/769-102/000-037



Obj. č.: 769-103

1 vodičová pružinová svorkovnice; 4 mm²; 3pól.; 4,00 mm²; Šedá

www.wago.com/769-103

	Obj. č.: 769-103/000-036 1 vodičová pružinová svorkovnice; 4 mm ² ; 3pól.; 4,00 mm ² ; Šedá / zelená – žlutá	www.wago.com/769-103/000-036
	Obj. č.: 769-103/000-037 1 vodičová pružinová svorkovnice; 4 mm ² ; 3pól.; 4,00 mm ² ; Zelená – žlutá / šedá	www.wago.com/769-103/000-037
	Obj. č.: 769-103/000-038 1 vodičová pružinová svorkovnice; 4 mm ² ; 3pól.; 4,00 mm ² ; Šedá / modrá / zelená – žlutá	www.wago.com/769-103/000-038
	Obj. č.: 769-103/000-039 1 vodičová pružinová svorkovnice; 4 mm ² ; 3pól.; 4,00 mm ² ; Zelená – žlutá, modrá, šedá	www.wago.com/769-103/000-039
	Obj. č.: 769-104 1 vodičová pružinová svorkovnice; 4 mm ² ; 4pól.; 4,00 mm ² ; Šedá	www.wago.com/769-104
	Obj. č.: 769-104/000-036 1 vodičová pružinová svorkovnice; 4 mm ² ; 4pól.; 4,00 mm ² ; Šedá / zelená – žlutá	www.wago.com/769-104/000-036
	Obj. č.: 769-104/000-037 1 vodičová pružinová svorkovnice; 4 mm ² ; 4pól.; 4,00 mm ² ; Zelená – žlutá / šedá	www.wago.com/769-104/000-037
	Obj. č.: 769-104/000-038 1 vodičová pružinová svorkovnice; 4 mm ² ; 4pól.; 4,00 mm ² ; Šedá / modrá / zelená – žlutá	www.wago.com/769-104/000-038
	Obj. č.: 769-104/000-039 1 vodičová pružinová svorkovnice; 4 mm ² ; 4pól.; 4,00 mm ² ; Zelená – žlutá, modrá, šedá	www.wago.com/769-104/000-039
	Obj. č.: 769-105 1 vodičová pružinová svorkovnice; 4 mm ² ; 5pól.; 4,00 mm ² ; Šedá	www.wago.com/769-105
	Obj. č.: 769-105/000-036 1 vodičová pružinová svorkovnice; 4 mm ² ; 5pól.; 4,00 mm ² ; Šedá / zelená – žlutá	www.wago.com/769-105/000-036
	Obj. č.: 769-105/000-037 1 vodičová pružinová svorkovnice; 4 mm ² ; 5pól.; 4,00 mm ² ; Zelená – žlutá / šedá	www.wago.com/769-105/000-037
	Obj. č.: 769-105/000-038 1 vodičová pružinová svorkovnice; 4 mm ² ; 5pól.; 4,00 mm ² ; Šedá / modrá / zelená – žlutá	www.wago.com/769-105/000-038
	Obj. č.: 769-105/000-039 1 vodičová pružinová svorkovnice; 4 mm ² ; 5pól.; 4,00 mm ² ; Zelená – žlutá, modrá, šedá	www.wago.com/769-105/000-039
	Obj. č.: 769-106 1 vodičová pružinová svorkovnice; 4 mm ² ; 6pól.; 4,00 mm ² ; Šedá	www.wago.com/769-106
	Obj. č.: 769-106/000-006 1 vodičová pružinová svorkovnice; 4 mm ² ; 6pól.; 4,00 mm ² ; Modrá	www.wago.com/769-106/000-006



Obj. č.: 769-106/000-036

1vodičová pružinová svorkovnice; 4 mm²; 6pól.; 4,00 mm²; Šedá / zelená – žlutá

www.wago.com/769-106/000-036

Obj. č.: 769-106/000-037

1vodičová pružinová svorkovnice; 4 mm²; 6pól.; 4,00 mm²; Zelená – žlutá / šedá

www.wago.com/769-106/000-037

Obj. č.: 769-106/000-038

1vodičová pružinová svorkovnice; 4 mm²; 6pól.; 4,00 mm²; Šedá / modrá / zelená – žlutá

www.wago.com/769-106/000-038

Obj. č.: 769-106/000-039

1vodičová pružinová svorkovnice; 4 mm²; 6pól.; 4,00 mm²; Zelená – žlutá, modrá, šedá

www.wago.com/769-106/000-039

Obj. č.: 769-107

1vodičová pružinová svorkovnice; 4 mm²; 7pól.; 4,00 mm²; Šedá

www.wago.com/769-107

Obj. č.: 769-107/000-036

1vodičová pružinová svorkovnice; 4 mm²; 7pól.; 4,00 mm²; Šedá / zelená – žlutá

www.wago.com/769-107/000-036

Obj. č.: 769-107/000-037

1vodičová pružinová svorkovnice; 4 mm²; 7pól.; 4,00 mm²; Zelená – žlutá / šedá

www.wago.com/769-107/000-037

Obj. č.: 769-107/000-038

1vodičová pružinová svorkovnice; 4 mm²; 7pól.; 4,00 mm²; Šedá / modrá / zelená – žlutá

www.wago.com/769-107/000-038

Obj. č.: 769-107/000-039

1vodičová pružinová svorkovnice; 4 mm²; 7pól.; 4,00 mm²; Zelená – žlutá, modrá, šedá

www.wago.com/769-107/000-039

Obj. č.: 769-108

1vodičová pružinová svorkovnice; 4 mm²; 8pól.; 4,00 mm²; Šedá

www.wago.com/769-108

Obj. č.: 769-108/000-036

1vodičová pružinová svorkovnice; 4 mm²; 8pól.; 4,00 mm²; Šedá / zelená – žlutá

www.wago.com/769-108/000-036

Obj. č.: 769-108/000-037

1vodičová pružinová svorkovnice; 4 mm²; 8pól.; 4,00 mm²; Zelená – žlutá / šedá

www.wago.com/769-108/000-037

Obj. č.: 769-108/000-038

1vodičová pružinová svorkovnice; 4 mm²; 8pól.; 4,00 mm²; Šedá / modrá / zelená – žlutá

www.wago.com/769-108/000-038

Obj. č.: 769-108/000-039

1vodičová pružinová svorkovnice; 4 mm²; 8pól.; 4,00 mm²; Zelená – žlutá, modrá, šedá

www.wago.com/769-108/000-039

Obj. č.: 769-109

1vodičová pružinová svorkovnice; 4 mm²; 9pól.; 4,00 mm²; Šedá

www.wago.com/769-109



Obj. č.: 769-109/000-036
1 vodičová pružinová svorkovnice; 4 mm²; 9pól.; 4,00 mm²; Šedá / zelená – žlutá

www.wago.com/769-109/000-036



Obj. č.: 769-109/000-037
1 vodičová pružinová svorkovnice; 4 mm²; 9pól.; 4,00 mm²; Zelená – žlutá / šedá

www.wago.com/769-109/000-037



Obj. č.: 769-109/000-038
1 vodičová pružinová svorkovnice; 4 mm²; 9pól.; 4,00 mm²; Šedá / modrá / zelená – žlutá

www.wago.com/769-109/000-038



Obj. č.: 769-109/000-039
1 vodičová pružinová svorkovnice; 4 mm²; 9pól.; 4,00 mm²; Zelená – žlutá, modrá, šedá

www.wago.com/769-109/000-039



Obj. č.: 769-110/000-036
1 vodičová pružinová svorkovnice; 4 mm²; 10pól.; 4,00 mm²; Šedá / zelená – žlutá

www.wago.com/769-110/000-036



Obj. č.: 769-110/000-037
1 vodičová pružinová svorkovnice; 4 mm²; 10pól.; 4,00 mm²; Zelená – žlutá / šedá

www.wago.com/769-110/000-037



Obj. č.: 769-110/000-038
1 vodičová pružinová svorkovnice; 4 mm²; 10pól.; 4,00 mm²; Šedá / modrá / zelená – žlutá

www.wago.com/769-110/000-038



Obj. č.: 769-110/000-039
1 vodičová pružinová svorkovnice; 4 mm²; 10pól.; 4,00 mm²; Zelená – žlutá, modrá, šedá

www.wago.com/769-110/000-039



Obj. č.: 769-121
2 vodičová pružinová svorkovnice; 4 mm²; 1pól.; 4,00 mm²; Šedá

www.wago.com/769-121



Obj. č.: 769-121/000-016
2 vodičová pružinová svorkovnice; 4 mm²; 1pól.; 4,00 mm²; Zeleno-žlutá

www.wago.com/769-121/000-016



Obj. č.: 769-122
2 vodičová pružinová svorkovnice; 4 mm²; 2pól.; 4,00 mm²; Šedá

www.wago.com/769-122



Obj. č.: 769-123
2 vodičová pružinová svorkovnice; 4 mm²; 3pól.; 4,00 mm²; Šedá

www.wago.com/769-123



Obj. č.: 769-124
2 vodičová pružinová svorkovnice; 4 mm²; 4pól.; 4,00 mm²; Šedá

www.wago.com/769-124



Obj. č.: 769-125
2 vodičová pružinová svorkovnice; 4 mm²; 5pól.; 4,00 mm²; Šedá

www.wago.com/769-125



Obj. č.: 769-126
2 vodičová pružinová svorkovnice; 4 mm²; 6pól.; 4,00 mm²; Šedá

www.wago.com/769-126



Obj. č.: 769-127
2 vodičová pružinová svorkovnice; 4 mm²; 7pól.; 4,00 mm²; Šedá

www.wago.com/769-127

	Obj. č.: 769-128 2vodičová pružinová svorkovnice; 4 mm ² ; 8pól.; 4,00 mm ² ; Šedá	www.wago.com/769-128
--	--	--

	Obj. č.: 769-129 2vodičová pružinová svorkovnice; 4 mm ² ; 9pól.; 4,00 mm ² ; Šedá	www.wago.com/769-129
--	--	--

Coding

	Obj. č.: 769-435 Kódovací kolík; Ke kódování pružinových svorkovnic; Pro základní svorky / konektory s pájecími piny; Oranžová	www.wago.com/769-435
--	--	--

tools

	Obj. č.: 210-490 Ovládací nástroj	www.wago.com/210-490
--	---	--

	Obj. č.: 769-434 Ovládací tlačítko; Volný	www.wago.com/769-434
--	---	--

Strain relief plate

	Obj. č.: 769-410 Podložka pro odlehčení tahu; Šedá	www.wago.com/769-410
--	--	--

	Obj. č.: 769-414 Podložka pro odlehčení tahu; Šedá	www.wago.com/769-414
--	--	--

Protective Warning Marker

	Obj. č.: 280-415 Výstražný kryt; S černým symbolem blesku; Pro 5 svorek; Žlutá	www.wago.com/280-415
---	--	--

Ke stažení

Documentation

Additional Information

Technical explanations	03-Apr-2019	pdf 2,1 MB	Stáhnout
------------------------	-------------	---------------	----------

CAD/CAE-Data

CAD data

2D/3D Models 769-610/005-000	URL	Stáhnout
------------------------------	-----	----------

CAE data

EPLAN Data Portal 769-610/005-000	Stáhnout
-----------------------------------	----------

WSCAD Universe 769-610/005-000	Stáhnout
--------------------------------	----------

Handling Instructions

Assembly

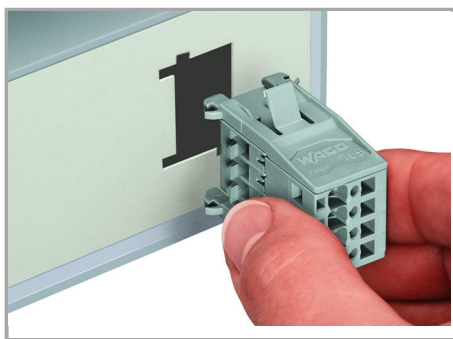

Insert male connector with snap-in flanges (769-604/005-000) into the cutout.

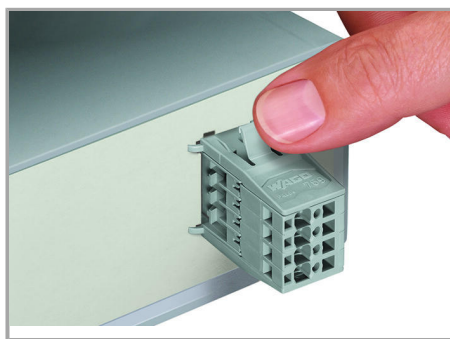

Male connector with snap-in flanges



Snap-in mounting without tools

Snap-in mounting without tools

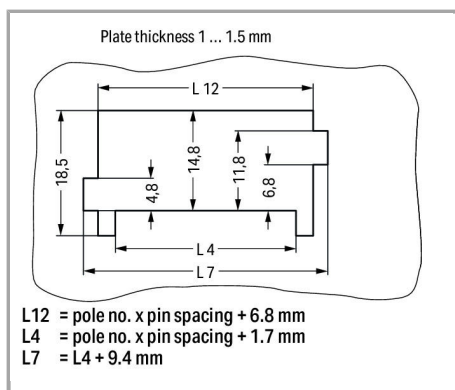

Sheet metal cutout

Male connectors with CAGE CLAMP® connection (769-6xx/005-000) and snap-in flanges

Inserting a conductor

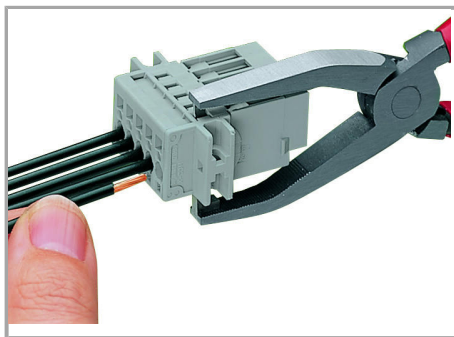

Operating tool

Inserting a conductor via operating tool
(example shows a male connector).

Marking

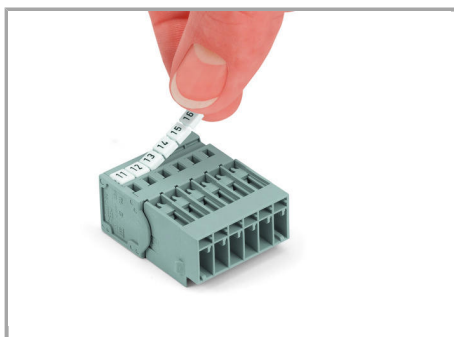

Labeling a male connector with
CAGE CLAMP® connection via Mini-WSB
quick markers.

Produktová rodina

X-COM

[Zobrazit všechny produkty z rodiny](#)

Změny vyhrazeny.