

Datový list | Objednací číslo: 769-608/001-000

1 vodičový konektor s pájecími piny; Západky; 4 mm²; Rozteč 5 mm; 8pól.;
4,00 mm²; Šedá



www.wago.com/769-608/001-000



RoHS
Compliant

BOMcheck.net

Barva: ■

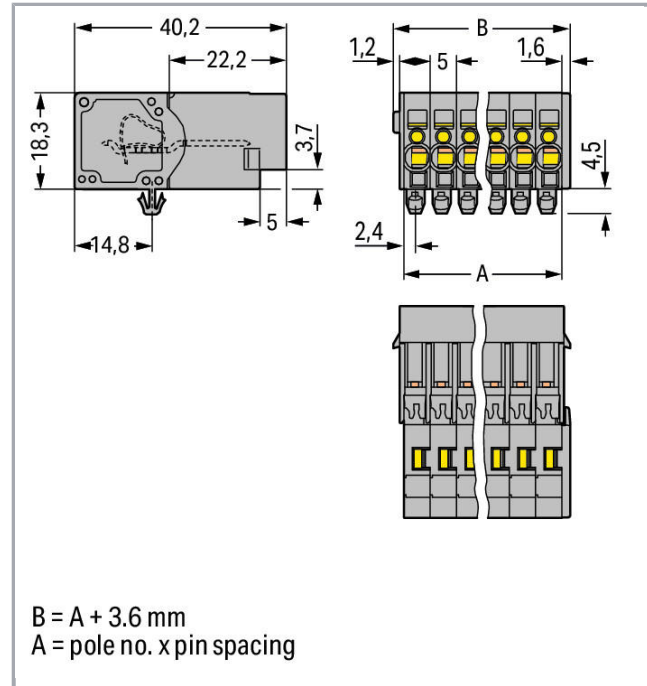

Data

Elektrické parametry

Ratings per IEC/EN 60664-1

Návrhové napětí (III / 3)	500 V
Návrhové rázové napětí (III / 3)	6 kV
Jmenovitý proud	32 A
Legenda (návrhové hodnoty)	(III / 3) ≙ kategorie přepětí III / stupeň znečištění 3

Údaje o připojení

Připojovací technika	CAGE CLAMP®
Způsob ovládání	Ovládací nástroj
Materiály připojitelných vodičů	Měď
Jmenovitý průřez	4 mm ²
Plný vodič	0,08 ... 4 mm ² / 28 ... 12 AWG
Jemně laněný vodič	0,08 ... 4 mm ² / 28 ... 12 AWG
Délka odizolování	8 ... 9 mm / 0.31 ... 0.35 palec



Počet pólů	8
Celkový počet kontaktních míst	8
Celkový počet potenciálů	8
Způsob zapojení	čelní připojení

Geometrické údaje

Rozteč	5 mm / 0.197 inch
Šířka	43,6 mm / 1.717 inch
Výška od povrchu	18,3 mm / 0.72 inch
Hloubka	40,2 mm / 1.583 inch

Mechanické parametry

Způsob upevnění	Západka
-----------------	---------

Plug connection

Typ kontaktu (konektor)	Konektor (vidlice) / zástrčka
Typ připojení konektoru	pro vodiče

Údaje o materiálu

barva	Šedá
Izolační materiál	Polyamid 66 (PA 66)
Požární zatížení	0.466 MJ
Hmotnost	23.648 g

Obchodní údaje

Druh balení	BOX
Country of origin	PL
GTIN	4044918522106
Customs Tariff No.	85366990990

Atesty/certifikáty**Specifické atesty jednotlivých států**

Logo	Schválení	Doplňkový text schválení	Název certifikátu
	CCA DEKRA Certification B.V.	IEC 61984	NL-47799
	CCA DEKRA Certification B.V.	EN 60947	NTR NL-7626
	CCA	EN 61984	2190419.02

DEKRA Certification B.V.



CSA
DEKRA Certification B.V.

C22.2 No. 158

1101144



KEMA/KEUR
DEKRA Certification B.V.



EN 60947

2190419.01

Atesty pro použití v lodním průmyslu

Logo	Schválení	Doplňkový text schválení	Název certifikátu
	DNV GL Det Norske Veritas, Germanischer Lloyd	-	TAE00001V2

Atesty UL

Logo	Schválení	Doplňkový text schválení	Název certifikátu
	UR Underwriters Laboratories Inc.	UL 1059	31.07.2019- E45172
	UR Underwriters Laboratories Inc.	UL 1977	E45171- 20010720

Kompatibilní produkty

Protective Warning Marker



Obj. č.: 280-415
Výstražný kryt; S černým symbolem blesku; Pro 5 svorek; Žlutá

www.wago.com/280-415

tools



Obj. č.: 210-490
Ovládací nástroj

www.wago.com/210-490



Obj. č.: 769-434
Ovládací tlačítko; Volný

www.wago.com/769-434

assembling



Obj. č.: 209-137
Montážní adaptér; Lze použít jako koncovou svěrku; Šířka 6,5 mm; Šedá

www.wago.com/209-137

ferrule



Obj. č.: 216-101
Dutinka; Objímka na 0,5 mm² / AWG 22; Bez plastového límce; Galvanicky pocínováno

www.wago.com/216-101



Obj. č.: 216-102
Dutinka; Objímka na 0,75 mm² / AWG 20; Bez plastového límce; Galvanicky pocínováno

www.wago.com/216-102



Obj. č.: 216-103
Dutinka; Objímka na 1 mm² / AWG 18; Bez plastového límce; Galvanicky pocínováno

www.wago.com/216-103



Obj. č.: 216-104
Dutinka; Objímka na 1,5 mm² / AWG 16; Bez plastového límce; Galvanicky pocínováno

www.wago.com/216-104



Obj. č.: 216-201
Ferrule; Sleeve for 0.5 mm² / 20 AWG; insulated; electro-tin plated; white

www.wago.com/216-201



Obj. č.: 216-202
Ferrule; Sleeve for 0.75 mm² / 18 AWG; insulated; electro-tin plated; gray

www.wago.com/216-202



Obj. č.: 216-203
Dutinka; Objímka na 1 mm² / AWG 18; S plastovým límcem; Galvanicky pocínováno; Červená

www.wago.com/216-203



Obj. č.: 216-204
Dutinka; Objímka na 1,5 mm² / AWG 16; S plastovým límcem; Galvanicky pocínováno; Černá

www.wago.com/216-204



Obj. č.: 216-206
Dutinka; Objímka na 2,5 mm² / AWG 14; S plastovým límcem; Galvanicky pocínováno; Modrá

www.wago.com/216-206

Coding



Obj. č.: 769-435
Kódovací kolík; Ke kódování pružinových svorkovnic; Pro základní svorky / konektory s pájecími piny; Oranžová

www.wago.com/769-435

Marking accessories



Obj. č.: 2009-145
Mini-WSB Inline; Pro Smart Printer; Na cívce; Flexibilní, 5–5,2 mm; Bez potisku; Možnost naklapnutí; Bílá

www.wago.com/2009-145



Obj. č.: 2009-145/000-002
Mini-WSB Inline; Pro Smart Printer; Na cívce; Flexibilní, 5–5,2 mm; Bez potisku; Možnost naklapnutí; Žlutá /000-002

www.wago.com/2009-145



















Obj. č.: 2009-145/000-005
Mini-WSB Inline; Pro Smart Printer; Na cívce; Flexibilní, 5–5,2 mm; Bez potisku; Možnost naklapnutí; Červená

www.wago.com/2009-145
/000-005



Obj. č.: 2009-145/000-006
Mini-WSB Inline; Pro Smart Printer; Na cívce; Flexibilní, 5–5,2 mm; Bez potisku; Možnost naklapnutí; Modrá

www.wago.com/2009-145
/000-006

	Obj. č.: 2009-145/000-007 Mini-WSB Inline; Pro Smart Printer; Na cívce; Flexibilní, 5–5,2 mm; Bez potisku; Možnost naklapnutí; Šedá /000-007	www.wago.com/2009-145/000-007
	Obj. č.: 2009-145/000-012 Mini-WSB Inline; Pro Smart Printer; Na cívce; Flexibilní, 5–5,2 mm; Bez potisku; Možnost naklapnutí; Oranžová	www.wago.com/2009-145/000-012
	Obj. č.: 2009-145/000-023 Mini-WSB Inline; Pro Smart Printer; Na cívce; Flexibilní, 5–5,2 mm; Bez potisku; Možnost naklapnutí; Zelená	www.wago.com/2009-145/000-023
	Obj. č.: 2009-145/000-024 Mini-WSB Inline; Pro Smart Printer; Na cívce; Flexibilní, 5–5,2 mm; Bez potisku; Možnost naklapnutí; Fialová	www.wago.com/2009-145/000-024
	Obj. č.: 210-831 Popisovací páska; Na cívce; Šířka 2,3 mm; Bez potisku; Samolepicí; Bílá	www.wago.com/210-831
	Obj. č.: 210-832 Popisovací páska; Na cívce; Šířka 3 mm; Bez potisku; Samolepicí; Bílá	www.wago.com/210-832
	Obj. č.: 210-833 Popisovací páska; Na cívce; Šířka 6 mm; Bez potisku; Samolepicí; Bílá	www.wago.com/210-833
	Obj. č.: 210-834 Popisovací páska; Na cívce; Šířka 5 mm; Bez potisku; Samolepicí; Bílá	www.wago.com/210-834
	Obj. č.: 248-501 Systém rychlého popisování Mini-WSB; Bez potisku; Šířka štítků 5 mm; 10 řad po 10 štítcích na každé kartě	www.wago.com/248-501
	Obj. č.: 248-501/000-002 Popisovací karta Mini-WSB; Jako karta; Neflexibilní; Bez potisku; Možnost naklapnutí; Žlutá	www.wago.com/248-501/000-002
	Obj. č.: 248-501/000-005 Popisovací karta Mini-WSB; Jako karta; Neflexibilní; Bez potisku; Možnost naklapnutí; Červená	www.wago.com/248-501/000-005
	Obj. č.: 248-501/000-006 Popisovací karta Mini-WSB; Jako karta; Neflexibilní; Bez potisku; Možnost naklapnutí; Modrá	www.wago.com/248-501/000-006
	Obj. č.: 248-501/000-007 Popisovací karta Mini-WSB; Jako karta; Neflexibilní; Bez potisku; Možnost naklapnutí; Šedá	www.wago.com/248-501/000-007
	Obj. č.: 248-501/000-012 Popisovací karta Mini-WSB; Jako karta; Neflexibilní; Bez potisku; Možnost naklapnutí; Oranžová	www.wago.com/248-501/000-012
	Obj. č.: 248-501/000-017 Popisovací karta Mini-WSB; Jako karta; Neflexibilní; Bez potisku; Možnost naklapnutí; Světle zelená	www.wago.com/248-501/000-017
	Obj. č.: 248-501/000-023 Popisovací karta Mini-WSB; Jako karta; Neflexibilní; Bez potisku; Možnost naklapnutí; Zelená	www.wago.com/248-501/000-023



Obj. č.: 248-501/000-024

Popisovací karta Mini-WSB; Jako karta; Neflexibilní; Bez potisku; Možnost naklapnutí; Fialová

www.wago.com/248-501/000-024

Strain relief plate



Obj. č.: 769-410

Podložka pro odlehčení tahu; Šedá

www.wago.com/769-410



Obj. č.: 769-413

Podložka pro odlehčení tahu; Šedá

www.wago.com/769-413

Insulation stop



Obj. č.: 769-470

Izolační zarážka; 0,08–0,2 mm² „e“ (0,14 mm² „f“); 5 ks/pás; Bílá

www.wago.com/769-470



Obj. č.: 769-471

Izolační zarážka; 0,25–0,5 mm²; 5 ks/pás; Světle šedá

www.wago.com/769-471



Obj. č.: 769-472

Izolační zarážka; 0,75–1 mm²; 5 ks/pás; Tmavě šedá

www.wago.com/769-472

Female plug



Obj. č.: 769-101

1vodičová pružinová svorkovnice; 4 mm²; 1pól.; 4,00 mm²; Šedá

www.wago.com/769-101



Obj. č.: 769-101/000-016

1vodičová pružinová svorkovnice; 4 mm²; 1pól.; 4,00 mm²; Zeleno-žlutá

www.wago.com/769-101/000-016



Obj. č.: 769-102

1vodičová pružinová svorkovnice; 4 mm²; 2pól.; 4,00 mm²; Šedá

www.wago.com/769-102



Obj. č.: 769-102/000-036

1vodičová pružinová svorkovnice; 4 mm²; 2pól.; 4,00 mm²; Šedá / zelená – žlutá

www.wago.com/769-102/000-036



Obj. č.: 769-102/000-037

1vodičová pružinová svorkovnice; 4 mm²; 2pól.; 4,00 mm²; Zelená – žlutá / šedá

www.wago.com/769-102/000-037



Obj. č.: 769-103

1vodičová pružinová svorkovnice; 4 mm²; 3pól.; 4,00 mm²; Šedá

www.wago.com/769-103



Obj. č.: 769-103/000-036

1vodičová pružinová svorkovnice; 4 mm²; 3pól.; 4,00 mm²; Šedá / zelená – žlutá

www.wago.com/769-103/000-036



Obj. č.: 769-103/000-037

1vodičová pružinová svorkovnice; 4 mm²; 3pól.; 4,00 mm²; Zelená – žlutá / šedá

www.wago.com/769-103/000-037



Obj. č.: 769-103/000-038

1vodičová pružinová svorkovnice; 4 mm²; 3pól.; 4,00 mm²; Šedá / modrá / zelená – žlutá















www.wago.com/769-103/000-038



















Obj. č.: 769-103/000-039

1vodičová pružinová svorkovnice; 4 mm²; 3pól.; 4,00 mm²; Zelená – žlutá, modrá, šedá

www.wago.com/769-103/000-039

	Obj. č.: 769-104 1vodičová pružinová svorkovnice; 4 mm ² ; 4pól.; 4,00 mm ² ; Šedá	www.wago.com/769-104
	Obj. č.: 769-104/000-036 1vodičová pružinová svorkovnice; 4 mm ² ; 4pól.; 4,00 mm ² ; Šedá / zelená – žlutá	www.wago.com/769-104/000-036
	Obj. č.: 769-104/000-037 1vodičová pružinová svorkovnice; 4 mm ² ; 4pól.; 4,00 mm ² ; Zelená – žlutá / šedá	www.wago.com/769-104/000-037
	Obj. č.: 769-104/000-038 1vodičová pružinová svorkovnice; 4 mm ² ; 4pól.; 4,00 mm ² ; Šedá / modrá / zelená – žlutá	www.wago.com/769-104/000-038
	Obj. č.: 769-104/000-039 1vodičová pružinová svorkovnice; 4 mm ² ; 4pól.; 4,00 mm ² ; Zelená – žlutá, modrá, šedá	www.wago.com/769-104/000-039
	Obj. č.: 769-105 1vodičová pružinová svorkovnice; 4 mm ² ; 5pól.; 4,00 mm ² ; Šedá	www.wago.com/769-105
	Obj. č.: 769-105/000-036 1vodičová pružinová svorkovnice; 4 mm ² ; 5pól.; 4,00 mm ² ; Šedá / zelená – žlutá	www.wago.com/769-105/000-036
	Obj. č.: 769-105/000-037 1vodičová pružinová svorkovnice; 4 mm ² ; 5pól.; 4,00 mm ² ; Zelená – žlutá / šedá	www.wago.com/769-105/000-037
	Obj. č.: 769-105/000-038 1vodičová pružinová svorkovnice; 4 mm ² ; 5pól.; 4,00 mm ² ; Šedá / modrá / zelená – žlutá	www.wago.com/769-105/000-038
	Obj. č.: 769-105/000-039 1vodičová pružinová svorkovnice; 4 mm ² ; 5pól.; 4,00 mm ² ; Zelená – žlutá, modrá, šedá	www.wago.com/769-105/000-039
	Obj. č.: 769-106 1vodičová pružinová svorkovnice; 4 mm ² ; 6pól.; 4,00 mm ² ; Šedá	www.wago.com/769-106
	Obj. č.: 769-106/000-006 1vodičová pružinová svorkovnice; 4 mm ² ; 6pól.; 4,00 mm ² ; Modrá	www.wago.com/769-106/000-006
	Obj. č.: 769-106/000-036 1vodičová pružinová svorkovnice; 4 mm ² ; 6pól.; 4,00 mm ² ; Šedá / zelená – žlutá	www.wago.com/769-106/000-036
	Obj. č.: 769-106/000-037 1vodičová pružinová svorkovnice; 4 mm ² ; 6pól.; 4,00 mm ² ; Zelená – žlutá / šedá	www.wago.com/769-106/000-037
	Obj. č.: 769-106/000-038 1vodičová pružinová svorkovnice; 4 mm ² ; 6pól.; 4,00 mm ² ; Šedá / modrá / zelená – žlutá	www.wago.com/769-106/000-038

	Obj. č.: 769-106/000-039 1 vodičová pružinová svorkovnice; 4 mm ² ; 6pól.; 4,00 mm ² ; Zelená – žlutá, modrá, šedá	www.wago.com/769-106/000-039
	Obj. č.: 769-107 1 vodičová pružinová svorkovnice; 4 mm ² ; 7pól.; 4,00 mm ² ; Šedá	www.wago.com/769-107
	Obj. č.: 769-107/000-036 1 vodičová pružinová svorkovnice; 4 mm ² ; 7pól.; 4,00 mm ² ; Šedá / zelená – žlutá	www.wago.com/769-107/000-036
	Obj. č.: 769-107/000-037 1 vodičová pružinová svorkovnice; 4 mm ² ; 7pól.; 4,00 mm ² ; Zelená – žlutá / šedá	www.wago.com/769-107/000-037
	Obj. č.: 769-107/000-038 1 vodičová pružinová svorkovnice; 4 mm ² ; 7pól.; 4,00 mm ² ; Šedá / modrá / zelená – žlutá	www.wago.com/769-107/000-038
	Obj. č.: 769-107/000-039 1 vodičová pružinová svorkovnice; 4 mm ² ; 7pól.; 4,00 mm ² ; Zelená – žlutá, modrá, šedá	www.wago.com/769-107/000-039
	Obj. č.: 769-108/000-036 1 vodičová pružinová svorkovnice; 4 mm ² ; 8pól.; 4,00 mm ² ; Šedá / zelená – žlutá	www.wago.com/769-108/000-036
	Obj. č.: 769-108/000-037 1 vodičová pružinová svorkovnice; 4 mm ² ; 8pól.; 4,00 mm ² ; Zelená – žlutá / šedá	www.wago.com/769-108/000-037
	Obj. č.: 769-108/000-038 1 vodičová pružinová svorkovnice; 4 mm ² ; 8pól.; 4,00 mm ² ; Šedá / modrá / zelená – žlutá	www.wago.com/769-108/000-038
	Obj. č.: 769-108/000-039 1 vodičová pružinová svorkovnice; 4 mm ² ; 8pól.; 4,00 mm ² ; Zelená – žlutá, modrá, šedá	www.wago.com/769-108/000-039
	Obj. č.: 769-121 2 vodičová pružinová svorkovnice; 4 mm ² ; 1pól.; 4,00 mm ² ; Šedá	www.wago.com/769-121
	Obj. č.: 769-122 2 vodičová pružinová svorkovnice; 4 mm ² ; 2pól.; 4,00 mm ² ; Šedá	www.wago.com/769-122
	Obj. č.: 769-123 2 vodičová pružinová svorkovnice; 4 mm ² ; 3pól.; 4,00 mm ² ; Šedá	www.wago.com/769-123
	Obj. č.: 769-124 2 vodičová pružinová svorkovnice; 4 mm ² ; 4pól.; 4,00 mm ² ; Šedá	www.wago.com/769-124
	Obj. č.: 769-125 2 vodičová pružinová svorkovnice; 4 mm ² ; 5pól.; 4,00 mm ² ; Šedá	www.wago.com/769-125
	Obj. č.: 769-126 2 vodičová pružinová svorkovnice; 4 mm ² ; 6pól.; 4,00 mm ² ; Šedá	www.wago.com/769-126
	Obj. č.: 769-127 2 vodičová pružinová svorkovnice; 4 mm ² ; 7pól.; 4,00 mm ² ; Šedá	www.wago.com/769-127



Ke stažení Documentation

Additional Information

Technical explanations	03-Apr-2019	pdf 2,1 MB	Stáhnout
------------------------	-------------	---------------	----------

CAD/CAE-Data

CAD data

2D/3D Models 769-608/001-000	URL	Stáhnout
------------------------------	-----	----------

CAE data

EPLAN Data Portal 769-608/001-000	Stáhnout
-----------------------------------	----------

WSCAD Universe 769-608/001-000	Stáhnout
--------------------------------	----------

Handling Instructions

Inserting a conductor

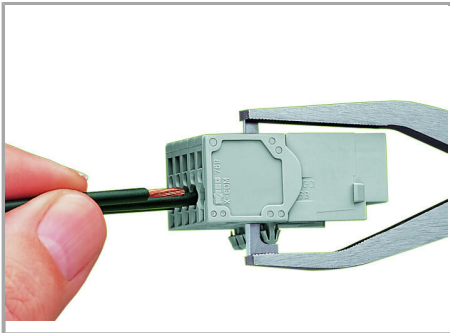

Operating tool

Inserting a conductor via operating tool
(example shows a male connector with snap-in mounting feet).

Application

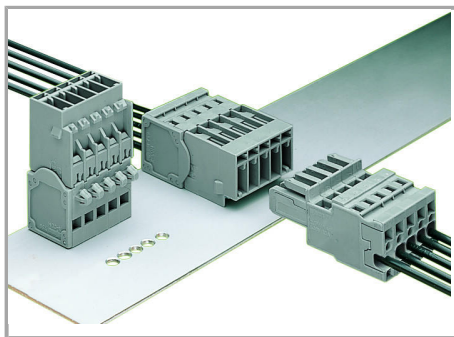

Male connector with CAGE CLAMP®
connection and snap-in mounting feet

1-connector female plug, straight

Marking

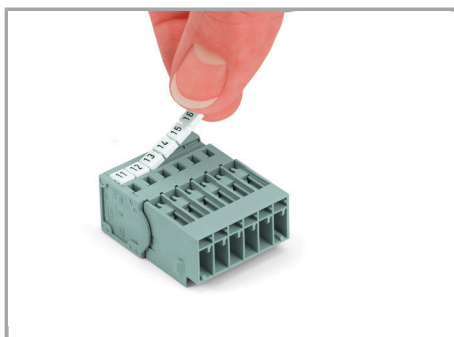

Labeling a male connector with
CAGE CLAMP® connection via Mini-WSB
quick markers.

Produktová rodina

X-COM

[Zobrazit všechny produkty z rodiny](#)

Změny vyhrazeny.