

Data

Elektrické parametry

Ratings per IEC/EN 60664-1

Návrhové napětí (III / 3)	400 V
Návrhové rázové napětí (III / 3)	6 kV
Jmenovitý proud	16 A
Legenda (návrhové hodnoty)	(III / 3) ≙ kategorie přepětí III / stupeň znečištění 3

Údaje o připojení

Celkový počet potenciálů	1
Počet úrovní	1
Způsob zapojení	čelní připojení

Geometrické údaje

Šířka	5 mm / 0.197 inch
Výška od horní hrany lišty DIN 35	28,5 mm / 1.122 inch
Hloubka	52,5 mm / 2.067 inch

Mechanické parametry

Provedení	Horizontální provedení
Způsob montáže	Lišta DIN 35
Úroveň popisování	Středový popis

Údaje o materiálu



barva	Šedá
Izolační materiál	Polyamid 66 (PA 66)
Požární zatížení	0.112 MJ
Hmotnost	5.087 g

Obchodní údaje

Product Group	18 (X-COM-System)
Druh balení	BOX
Country of origin	DE
GTIN	4045454619404
Customs Tariff No.	85365080900



Atesty/certifikáty

Specifické atesty jednotlivých států



Logo	Schválení	Doplňkový text schválení	Název certifikátu
	CCA DEKRA Certification B.V.	EN 60947	NTR NL-7626
	CSA DEKRA Certification B.V.	C22.2 No. 158	1101144
	KEMA/KEUR DEKRA Certification B.V.	EN 60947	2190419.01

Atesty pro použití v lodním průmyslu

Název



Logo	Schválení	Doplňkový text schválení	certifikátu
	ABS American Bureau of Shipping	EN 60947	14- HG1293677- PDA
	DNV GL Det Norske Veritas, Germanischer Lloyd	-	TAE00001V2
	LR Lloyds Register	EN 60947	91/20112 (E9)

















Atesty UL















Logo	Schválení	Doplňkový text schválení	Název certifikátu
	UR Underwriters Laboratories Inc.	UL 1977	E45171- 20010720
	UR Underwriters Laboratories Inc.	UL 1059	20190731- E45172















Kompatibilní produkty

General accessories

	Obj. č.: 709-170 Blokovací pojistka proti zapojení; Pro rozpojovací vidlice rozpojovacích svorek řad 280/281 a 769; Červená	www.wago.com/709-170
	Obj. č.: 769-438 Kryt kolíků; S držákem značení pro Mini-WSB; Šedá	www.wago.com/769-438
	Obj. č.: 769-439 Kryt kolíků; S držákem značení pro Mini-WSB; Oranžová	www.wago.com/769-439
	Obj. č.: 769-501 1 vodičový počáteční modul s pružinovou svorkovnicí; S integrovanou koncovou bočnicí; 4 mm ² ; 1pól;	www.wago.com/769-501

	4,00 mm ² ; Šedá	
	Obj. č.: 769-501/000-006 1vodičový počáteční modul s pružinovou svorkovnicí; 4 mm ² ; 1pól.; 4,00 mm ² ; Modrá	www.wago.com/769-501/000-006
	Obj. č.: 769-501/000-016 1vodičový počáteční modul s pružinovou svorkovnicí; S integrovanou koncovou bočnicí; 4 mm ² ; 1pól.; 4,00 mm ² ; Zeleno-žlutá	www.wago.com/769-501/000-016
	Obj. č.: 769-502 1vodičový středový modul s pružinovou svorkovnicí; 4 mm ² ; 1pól.; 4,00 mm ² ; Šedá	www.wago.com/769-502
	Obj. č.: 769-502/000-006 1vodičový středový modul s pružinovou svorkovnicí; 4 mm ² ; 1pól.; 4,00 mm ² ; Modrá	www.wago.com/769-502/000-006
	Obj. č.: 769-502/000-016 1vodičový středový modul s pružinovou svorkovnicí; 4 mm ² ; 1pól.; 4,00 mm ² ; Zeleno-žlutá	www.wago.com/769-502/000-016
	Obj. č.: 769-503 1vodičový koncový modul s pružinovou svorkovnicí; 4 mm ² ; 1pól.; 4,00 mm ² ; Šedá	www.wago.com/769-503
	Obj. č.: 769-503/000-006 1vodičový koncový modul s pružinovou svorkovnicí; 4 mm ² ; 1pól.; 4,00 mm ² ; Modrá	www.wago.com/769-503/000-006
	Obj. č.: 769-503/000-016 1vodičový koncový modul s pružinovou svorkovnicí; 4 mm ² ; 1pól.; 4,00 mm ² ; Zeleno-žlutá	www.wago.com/769-503/000-016
	Obj. č.: 769-504 2vodičový počáteční modul s pružinovou svorkovnicí; S integrovanou koncovou bočnicí; 4 mm ² ; 1pól.; 4,00 mm ² ; Šedá	www.wago.com/769-504
	Obj. č.: 769-504/000-006 2vodičový počáteční modul s pružinovou svorkovnicí; S integrovanou koncovou bočnicí; 4 mm ² ; 1pól.; 4,00 mm ² ; Modrá	www.wago.com/769-504/000-006
	Obj. č.: 769-504/000-016 2vodičový počáteční modul s pružinovou svorkovnicí; 4 mm ² ; 1pól.; 4,00 mm ² ; Zeleno-žlutá	www.wago.com/769-504/000-016
	Obj. č.: 769-505 2vodičový středový modul s pružinovou svorkovnicí; 4 mm ² ; 1pól.; 4,00 mm ² ; Šedá	www.wago.com/769-505
	Obj. č.: 769-505/000-006 2vodičový středový modul s pružinovou svorkovnicí; 4 mm ² ; 1pól.; 4,00 mm ² ; Modrá	www.wago.com/769-505/000-006
	Obj. č.: 769-505/000-016 2vodičový středový modul s pružinovou svorkovnicí; 4 mm ² ; 1pól.; 4,00 mm ² ; Zeleno-žlutá	www.wago.com/769-505/000-016
	Obj. č.: 769-506 2vodičový koncový modul s pružinovou svorkovnicí; 4 mm ² ; 1pól.; 4,00 mm ² ; Šedá	www.wago.com/769-506

	Obj. č.: 769-506/000-006 2vodičový koncový modul s pružinovou svorkovnicí; 4 mm ² ; 1pól.; 4,00 mm ² ; Modrá	www.wago.com/769-506/000-006
	Obj. č.: 769-506/000-016 2vodičový koncový modul s pružinovou svorkovnicí; 4 mm ² ; 1pól.; 4,00 mm ² ; Zeleno-žlutá	www.wago.com/769-506/000-016
	Obj. č.: 769-512 1vodičový počáteční modul s pružinovou svorkovnicí; Úhlové provedení; 4 mm ² ; 1pól.; 4,00 mm ² ; Šedá	www.wago.com/769-512
	Obj. č.: 769-512/000-006 1vodičový počáteční modul s pružinovou svorkovnicí; Úhlové provedení; 4 mm ² ; 1pól.; 4,00 mm ² ; Modrá	www.wago.com/769-512/000-006
	Obj. č.: 769-512/000-016 1vodičový počáteční modul s pružinovou svorkovnicí; Úhlové provedení; 4 mm ² ; 1pól.; 4,00 mm ² ; Zeleno-žlutá	www.wago.com/769-512/000-016
	Obj. č.: 769-513 1vodičový středový modul s pružinovou svorkovnicí; Úhlové provedení; 4 mm ² ; 1pól.; 4,00 mm ² ; Šedá	www.wago.com/769-513
	Obj. č.: 769-513/000-006 1vodičový středový modul s pružinovou svorkovnicí; Úhlové provedení; 4 mm ² ; 1pól.; 4,00 mm ² ; Modrá	www.wago.com/769-513/000-006
	Obj. č.: 769-513/000-016 1vodičový středový modul s pružinovou svorkovnicí; Úhlové provedení; 4 mm ² ; 1pól.; 4,00 mm ² ; Zeleno-žlutá	www.wago.com/769-513/000-016
	Obj. č.: 769-515 1vodičový koncový modul s pružinovou svorkovnicí; Úhlové provedení; 4 mm ² ; 1pól.; 4,00 mm ² ; Šedá	www.wago.com/769-515
	Obj. č.: 769-515/000-006 1vodičový koncový modul s pružinovou svorkovnicí; Úhlové provedení; 4 mm ² ; 1pól.; 4,00 mm ² ; Modrá	www.wago.com/769-515/000-006
	Obj. č.: 769-515/000-016 1vodičový koncový modul s pružinovou svorkovnicí; Úhlové provedení; 4 mm ² ; 1pól.; 4,00 mm ² ; Zeleno-žlutá	www.wago.com/769-515/000-016
Coding		
	Obj. č.: 769-435 Kódovací kolík; Ke kódování pružinových svorkovnic; Pro základní svorky / konektory s pájecími piny; Oranžová	www.wago.com/769-435
check		
	Obj. č.: 210-137 Zkušební hrot; Ø 2,3 mm; S 500mm vedením; Žlutá	www.wago.com/210-137
Marking accessories		
	Obj. č.: 2009-145 Mini-WSB Inline; Pro Smart Printer; Na cívce; Flexibilní, 5–5,2 mm; Bez potisku; Možnost naklapnutí; Bílá	www.wago.com/2009-145
	Obj. č.: 2009-145/000-002 Mini-WSB Inline; Pro Smart Printer; Na cívce; Flexibilní, 5–5,2 mm; Bez potisku; Možnost naklapnutí; Žlutá	www.wago.com/2009-145/000-002
Obj. č.: 2009-145/000-005		

	Mini-WSB Inline; Pro Smart Printer; Na cívce; Flexibilní, 5–5,2 mm; Bez potisku; Možnost naklapnutí; Červená	www.wago.com/2009-145/000-005
	Obj. č.: 2009-145/000-006 Mini-WSB Inline; Pro Smart Printer; Na cívce; Flexibilní, 5–5,2 mm; Bez potisku; Možnost naklapnutí; Modrá	www.wago.com/2009-145/000-006
	Obj. č.: 2009-145/000-007 Mini-WSB Inline; Pro Smart Printer; Na cívce; Flexibilní, 5–5,2 mm; Bez potisku; Možnost naklapnutí; Šedá	www.wago.com/2009-145/000-007
	Obj. č.: 2009-145/000-012 Mini-WSB Inline; Pro Smart Printer; Na cívce; Flexibilní, 5–5,2 mm; Bez potisku; Možnost naklapnutí; Oranžová	www.wago.com/2009-145/000-012
	Obj. č.: 2009-145/000-023 Mini-WSB Inline; Pro Smart Printer; Na cívce; Flexibilní, 5–5,2 mm; Bez potisku; Možnost naklapnutí; Zelená	www.wago.com/2009-145/000-023
	Obj. č.: 2009-145/000-024 Mini-WSB Inline; Pro Smart Printer; Na cívce; Flexibilní, 5–5,2 mm; Bez potisku; Možnost naklapnutí; Fialová	www.wago.com/2009-145/000-024
	Obj. č.: 248-501 Systém rychlého popisování Mini-WSB; Bez potisku; Šířka štítků 5 mm; 10 řad po 10 štítcích na každé kartě	www.wago.com/248-501
	Obj. č.: 248-501/000-002 Popisovací karta Mini-WSB; Jako karta; Neflexibilní; Bez potisku; Možnost naklapnutí; Žlutá	www.wago.com/248-501/000-002
	Obj. č.: 248-501/000-005 Popisovací karta Mini-WSB; Jako karta; Neflexibilní; Bez potisku; Možnost naklapnutí; Červená	www.wago.com/248-501/000-005
	Obj. č.: 248-501/000-006 Popisovací karta Mini-WSB; Jako karta; Neflexibilní; Bez potisku; Možnost naklapnutí; Modrá	www.wago.com/248-501/000-006
	Obj. č.: 248-501/000-007 Popisovací karta Mini-WSB; Jako karta; Neflexibilní; Bez potisku; Možnost naklapnutí; Šedá	www.wago.com/248-501/000-007
	Obj. č.: 248-501/000-012 Popisovací karta Mini-WSB; Jako karta; Neflexibilní; Bez potisku; Možnost naklapnutí; Oranžová	www.wago.com/248-501/000-012
	Obj. č.: 248-501/000-017 Popisovací karta Mini-WSB; Jako karta; Neflexibilní; Bez potisku; Možnost naklapnutí; Světle zelená	www.wago.com/248-501/000-017
	Obj. č.: 248-501/000-023 Popisovací karta Mini-WSB; Jako karta; Neflexibilní; Bez potisku; Možnost naklapnutí; Zelená	www.wago.com/248-501/000-023
	Obj. č.: 248-501/000-024 Popisovací karta Mini-WSB; Jako karta; Neflexibilní; Bez potisku; Možnost naklapnutí; Fialová	www.wago.com/248-501/000-024

assembling



Obj. č.: 209-106
Držák; K izolované montáži nosných lišt DIN 35; Šedá

www.wago.com/209-106

Female plug



Obj. č.: 769-101
1 vodičová pružinová svorkovnice; 4 mm²; 1pól.; 4,00 mm²; Šedá

www.wago.com/769-101



Obj. č.: 769-101/000-006
1 vodičová pružinová svorkovnice; 4 mm²; 1pól.; 4,00 mm²; Modrá

www.wago.com/769-101/000-006



Obj. č.: 769-101/000-016
1 vodičová pružinová svorkovnice; 4 mm²; 1pól.; 4,00 mm²; Zeleno-žlutá

www.wago.com/769-101/000-016



Obj. č.: 769-101/022-000
1 vodičová pružinová svorkovnice; Úhlové provedení; 4 mm²; 1pól.; 4,00 mm²; Šedá

www.wago.com/769-101/022-000



Obj. č.: 769-101/022-016
1 vodičová pružinová svorkovnice; Úhlové provedení; 4 mm²; 1pól.; 4,00 mm²; Zeleno-žlutá

www.wago.com/769-101/022-016



Obj. č.: 769-102
1 vodičová pružinová svorkovnice; 4 mm²; 2pól.; 4,00 mm²; Šedá

www.wago.com/769-102



Obj. č.: 769-102/000-006
1 vodičová pružinová svorkovnice; 4 mm²; 2pól.; 4,00 mm²; Modrá

www.wago.com/769-102/000-006



Obj. č.: 769-102/000-036
1 vodičová pružinová svorkovnice; 4 mm²; 2pól.; 4,00 mm²; Šedá / zelená – žlutá

www.wago.com/769-102/000-036



Obj. č.: 769-102/000-037
1 vodičová pružinová svorkovnice; 4 mm²; 2pól.; 4,00 mm²; Zelená – žlutá / šedá

www.wago.com/769-102/000-037



Obj. č.: 769-102/022-000
1 vodičová pružinová svorkovnice; Úhlové provedení; 4 mm²; 2pól.; 4,00 mm²; Šedá

www.wago.com/769-102/022-000



Obj. č.: 769-103
1 vodičová pružinová svorkovnice; 4 mm²; 3pól.; 4,00 mm²; Šedá

www.wago.com/769-103



Obj. č.: 769-103/000-006
1 vodičová pružinová svorkovnice; 4 mm²; 3pól.; 4,00 mm²; Modrá

www.wago.com/769-103/000-006

















Obj. č.: 769-103/000-036
1 vodičová pružinová svorkovnice; 4 mm²; 3pól.; 4,00 mm²; Šedá / zelená – žlutá















www.wago.com/769-103/000-036

































Obj. č.: 769-103/000-037
1 vodičová pružinová svorkovnice; 4 mm²; 3pól.; 4,00 mm²; Zelená – žlutá / šedá















www.wago.com/769-103/000-037

	Obj. č.: 769-103/000-038 1 vodičová pružinová svorkovnice; 4 mm ² ; 3pól.; 4,00 mm ² ; Šedá / modrá / zelená – žlutá	www.wago.com/769-103/000-038
	Obj. č.: 769-103/000-039 1 vodičová pružinová svorkovnice; 4 mm ² ; 3pól.; 4,00 mm ² ; Zelená – žlutá, modrá, šedá	www.wago.com/769-103/000-039
	Obj. č.: 769-103/022-000 1 vodičová pružinová svorkovnice; Úhlové provedení; 4 mm ² ; 3pól.; 4,00 mm ² ; Šedá	www.wago.com/769-103/022-000
	Obj. č.: 769-104 1 vodičová pružinová svorkovnice; 4 mm ² ; 4pól.; 4,00 mm ² ; Šedá	www.wago.com/769-104
	Obj. č.: 769-104/000-006 1 vodičová pružinová svorkovnice; 4 mm ² ; 4pól.; 4,00 mm ² ; Modrá	www.wago.com/769-104/000-006
	Obj. č.: 769-104/000-036 1 vodičová pružinová svorkovnice; 4 mm ² ; 4pól.; 4,00 mm ² ; Šedá / zelená – žlutá	www.wago.com/769-104/000-036
	Obj. č.: 769-104/000-037 1 vodičová pružinová svorkovnice; 4 mm ² ; 4pól.; 4,00 mm ² ; Zelená – žlutá / šedá	www.wago.com/769-104/000-037
	Obj. č.: 769-104/000-038 1 vodičová pružinová svorkovnice; 4 mm ² ; 4pól.; 4,00 mm ² ; Šedá / modrá / zelená – žlutá	www.wago.com/769-104/000-038
	Obj. č.: 769-104/000-039 1 vodičová pružinová svorkovnice; 4 mm ² ; 4pól.; 4,00 mm ² ; Zelená – žlutá, modrá, šedá	www.wago.com/769-104/000-039
	Obj. č.: 769-104/022-000 1 vodičová pružinová svorkovnice; Úhlové provedení; 4 mm ² ; 4pól.; 4,00 mm ² ; Šedá	www.wago.com/769-104/022-000
	Obj. č.: 769-105 1 vodičová pružinová svorkovnice; 4 mm ² ; 5pól.; 4,00 mm ² ; Šedá	www.wago.com/769-105
	Obj. č.: 769-105/000-006 1 vodičová pružinová svorkovnice; 4 mm ² ; 5pól.; 4,00 mm ² ; Modrá	www.wago.com/769-105/000-006
	Obj. č.: 769-105/000-036 1 vodičová pružinová svorkovnice; 4 mm ² ; 5pól.; 4,00 mm ² ; Šedá / zelená – žlutá	www.wago.com/769-105/000-036
	Obj. č.: 769-105/000-037 1 vodičová pružinová svorkovnice; 4 mm ² ; 5pól.; 4,00 mm ² ; Zelená – žlutá / šedá	www.wago.com/769-105/000-037
	Obj. č.: 769-105/000-038 1 vodičová pružinová svorkovnice; 4 mm ² ; 5pól.; 4,00 mm ² ; Šedá / modrá / zelená – žlutá	www.wago.com/769-105/000-038

	Obj. č.: 769-105/000-039 1 vodičová pružinová svorkovnice; 4 mm ² ; 5pól.; 4,00 mm ² ; Zelená – žlutá, modrá, šedá	www.wago.com/769-105/000-039
	Obj. č.: 769-105/022-000 1 vodičová pružinová svorkovnice; Úhlové provedení; 4 mm ² ; 5pól.; 4,00 mm ² ; Šedá	www.wago.com/769-105/022-000
	Obj. č.: 769-106 1 vodičová pružinová svorkovnice; 4 mm ² ; 6pól.; 4,00 mm ² ; Šedá	www.wago.com/769-106
	Obj. č.: 769-106/000-006 1 vodičová pružinová svorkovnice; 4 mm ² ; 6pól.; 4,00 mm ² ; Modrá	www.wago.com/769-106/000-006
	Obj. č.: 769-106/000-036 1 vodičová pružinová svorkovnice; 4 mm ² ; 6pól.; 4,00 mm ² ; Šedá / zelená – žlutá	www.wago.com/769-106/000-036
	Obj. č.: 769-106/000-037 1 vodičová pružinová svorkovnice; 4 mm ² ; 6pól.; 4,00 mm ² ; Zelená – žlutá / šedá	www.wago.com/769-106/000-037
	Obj. č.: 769-106/000-038 1 vodičová pružinová svorkovnice; 4 mm ² ; 6pól.; 4,00 mm ² ; Šedá / modrá / zelená – žlutá	www.wago.com/769-106/000-038
	Obj. č.: 769-106/000-039 1 vodičová pružinová svorkovnice; 4 mm ² ; 6pól.; 4,00 mm ² ; Zelená – žlutá, modrá, šedá	www.wago.com/769-106/000-039
	Obj. č.: 769-106/022-000 1 vodičová pružinová svorkovnice; Úhlové provedení; 4 mm ² ; 6pól.; 4,00 mm ² ; Šedá	www.wago.com/769-106/022-000
	Obj. č.: 769-107 1 vodičová pružinová svorkovnice; 4 mm ² ; 7pól.; 4,00 mm ² ; Šedá	www.wago.com/769-107
	Obj. č.: 769-107/000-006 1 vodičová pružinová svorkovnice; 4 mm ² ; 7pól.; 4,00 mm ² ; Modrá	www.wago.com/769-107/000-006
	Obj. č.: 769-107/000-036 1 vodičová pružinová svorkovnice; 4 mm ² ; 7pól.; 4,00 mm ² ; Šedá / zelená – žlutá	www.wago.com/769-107/000-036
	Obj. č.: 769-107/000-037 1 vodičová pružinová svorkovnice; 4 mm ² ; 7pól.; 4,00 mm ² ; Zelená – žlutá / šedá	www.wago.com/769-107/000-037
	Obj. č.: 769-107/000-038 1 vodičová pružinová svorkovnice; 4 mm ² ; 7pól.; 4,00 mm ² ; Šedá / modrá / zelená – žlutá	www.wago.com/769-107/000-038
	Obj. č.: 769-107/000-039 1 vodičová pružinová svorkovnice; 4 mm ² ; 7pól.; 4,00 mm ² ; Zelená – žlutá, modrá, šedá	www.wago.com/769-107/000-039

	Obj. č.: 769-107/022-000 1 vodičová pružinová svorkovnice; Úhlové provedení; 4 mm ² ; 7pól.; 4,00 mm ² ; Šedá	www.wago.com/769-107/022-000
	Obj. č.: 769-108 1 vodičová pružinová svorkovnice; 4 mm ² ; 8pól.; 4,00 mm ² ; Šedá	www.wago.com/769-108
	Obj. č.: 769-108/000-006 1 vodičová pružinová svorkovnice; 4 mm ² ; 8pól.; 4,00 mm ² ; Modrá	www.wago.com/769-108/000-006
	Obj. č.: 769-108/000-036 1 vodičová pružinová svorkovnice; 4 mm ² ; 8pól.; 4,00 mm ² ; Šedá / zelená – žlutá	www.wago.com/769-108/000-036
	Obj. č.: 769-108/000-037 1 vodičová pružinová svorkovnice; 4 mm ² ; 8pól.; 4,00 mm ² ; Zelená – žlutá / šedá	www.wago.com/769-108/000-037
	Obj. č.: 769-108/000-038 1 vodičová pružinová svorkovnice; 4 mm ² ; 8pól.; 4,00 mm ² ; Šedá / modrá / zelená – žlutá	www.wago.com/769-108/000-038
	Obj. č.: 769-108/000-039 1 vodičová pružinová svorkovnice; 4 mm ² ; 8pól.; 4,00 mm ² ; Zelená – žlutá, modrá, šedá	www.wago.com/769-108/000-039
	Obj. č.: 769-108/022-000 1 vodičová pružinová svorkovnice; Úhlové provedení; 4 mm ² ; 8pól.; 4,00 mm ² ; Šedá	www.wago.com/769-108/022-000
	Obj. č.: 769-109 1 vodičová pružinová svorkovnice; 4 mm ² ; 9pól.; 4,00 mm ² ; Šedá	www.wago.com/769-109
	Obj. č.: 769-109/000-006 1 vodičová pružinová svorkovnice; 4 mm ² ; 9pól.; 4,00 mm ² ; Modrá	www.wago.com/769-109/000-006
	Obj. č.: 769-109/000-036 1 vodičová pružinová svorkovnice; 4 mm ² ; 9pól.; 4,00 mm ² ; Šedá / zelená – žlutá	www.wago.com/769-109/000-036
	Obj. č.: 769-109/000-037 1 vodičová pružinová svorkovnice; 4 mm ² ; 9pól.; 4,00 mm ² ; Zelená – žlutá / šedá	www.wago.com/769-109/000-037
	Obj. č.: 769-109/000-038 1 vodičová pružinová svorkovnice; 4 mm ² ; 9pól.; 4,00 mm ² ; Šedá / modrá / zelená – žlutá	www.wago.com/769-109/000-038
	Obj. č.: 769-109/000-039 1 vodičová pružinová svorkovnice; 4 mm ² ; 9pól.; 4,00 mm ² ; Zelená – žlutá, modrá, šedá	www.wago.com/769-109/000-039
	Obj. č.: 769-109/022-000 1 vodičová pružinová svorkovnice; Úhlové provedení; 4 mm ² ; 9pól.; 4,00 mm ² ; Šedá	www.wago.com/769-109/022-000

	Obj. č.: 769-110 1vodičová pružinová svorkovnice; 4 mm ² ; 10pól.; 4,00 mm ² ; Šedá	www.wago.com/769-110
	Obj. č.: 769-110/000-006 1vodičová pružinová svorkovnice; 4 mm ² ; 10pól.; 4,00 mm ² ; Modrá	www.wago.com/769-110/000-006
	Obj. č.: 769-110/000-036 1vodičová pružinová svorkovnice; 4 mm ² ; 10pól.; 4,00 mm ² ; Šedá / zelená – žlutá	www.wago.com/769-110/000-036
	Obj. č.: 769-110/000-037 1vodičová pružinová svorkovnice; 4 mm ² ; 10pól.; 4,00 mm ² ; Zelená – žlutá / šedá	www.wago.com/769-110/000-037
	Obj. č.: 769-110/000-038 1vodičová pružinová svorkovnice; 4 mm ² ; 10pól.; 4,00 mm ² ; Šedá / modrá / zelená – žlutá	www.wago.com/769-110/000-038
	Obj. č.: 769-110/000-039 1vodičová pružinová svorkovnice; 4 mm ² ; 10pól.; 4,00 mm ² ; Zelená – žlutá, modrá, šedá	www.wago.com/769-110/000-039
	Obj. č.: 769-110/022-000 1vodičová pružinová svorkovnice; Úhlové provedení; 4 mm ² ; 10pól.; 4,00 mm ² ; Šedá	www.wago.com/769-110/022-000
	Obj. č.: 769-111 1vodičová pružinová svorkovnice; 4 mm ² ; 11pól.; 4,00 mm ² ; Šedá	www.wago.com/769-111
	Obj. č.: 769-111/000-006 1vodičová pružinová svorkovnice; 4 mm ² ; 11pól.; 4,00 mm ² ; Modrá	www.wago.com/769-111/000-006
	Obj. č.: 769-111/000-036 1vodičová pružinová svorkovnice; 4 mm ² ; 11pól.; 4,00 mm ² ; Šedá / zelená – žlutá	www.wago.com/769-111/000-036
	Obj. č.: 769-111/000-037 1vodičová pružinová svorkovnice; 4 mm ² ; 11pól.; 4,00 mm ² ; Zelená – žlutá / šedá	www.wago.com/769-111/000-037
	Obj. č.: 769-111/000-038 1vodičová pružinová svorkovnice; 4 mm ² ; 11pól.; 4,00 mm ² ; Šedá / modrá / zelená – žlutá	www.wago.com/769-111/000-038
	Obj. č.: 769-111/000-039 1vodičová pružinová svorkovnice; 4 mm ² ; 11pól.; 4,00 mm ² ; Zelená – žlutá, modrá, šedá	www.wago.com/769-111/000-039
	Obj. č.: 769-111/022-000 1vodičová pružinová svorkovnice; Úhlové provedení; 4 mm ² ; 11pól.; 4,00 mm ² ; Šedá	www.wago.com/769-111/022-000
	Obj. č.: 769-112 1vodičová pružinová svorkovnice; 4 mm ² ; 12pól.; 4,00 mm ² ; Šedá	www.wago.com/769-112

	Obj. č.: 769-112/000-006 1 vodičová pružinová svorkovnice; 4 mm ² ; 12pól.; 4,00 mm ² ; Modrá	www.wago.com/769-112/000-006
	Obj. č.: 769-112/000-036 1 vodičová pružinová svorkovnice; 4 mm ² ; 12pól.; 4,00 mm ² ; Šedá / zelená – žlutá	www.wago.com/769-112/000-036
	Obj. č.: 769-112/000-037 1 vodičová pružinová svorkovnice; 4 mm ² ; 12pól.; 4,00 mm ² ; Zelená – žlutá / šedá	www.wago.com/769-112/000-037
	Obj. č.: 769-112/000-038 1 vodičová pružinová svorkovnice; 4 mm ² ; 12pól.; 4,00 mm ² ; Šedá / modrá / zelená – žlutá	www.wago.com/769-112/000-038
	Obj. č.: 769-112/000-039 1 vodičová pružinová svorkovnice; 4 mm ² ; 12pól.; 4,00 mm ² ; Zelená – žlutá, modrá, šedá	www.wago.com/769-112/000-039
	Obj. č.: 769-112/022-000 1 vodičová pružinová svorkovnice; Úhlové provedení; 4 mm ² ; 12pól.; 4,00 mm ² ; Šedá	www.wago.com/769-112/022-000
	Obj. č.: 769-113 1 vodičová pružinová svorkovnice; 4 mm ² ; 13pól.; 4,00 mm ² ; Šedá	www.wago.com/769-113
	Obj. č.: 769-113/000-036 1 vodičová pružinová svorkovnice; 4 mm ² ; 13pól.; 4,00 mm ² ; Šedá / zelená – žlutá	www.wago.com/769-113/000-036
	Obj. č.: 769-113/000-037 1 vodičová pružinová svorkovnice; 4 mm ² ; 13pól.; 4,00 mm ² ; Zelená – žlutá / šedá	www.wago.com/769-113/000-037
	Obj. č.: 769-113/000-038 1 vodičová pružinová svorkovnice; 4 mm ² ; 13pól.; 4,00 mm ² ; Šedá / modrá / zelená – žlutá	www.wago.com/769-113/000-038
	Obj. č.: 769-113/000-039 1 vodičová pružinová svorkovnice; 4 mm ² ; 13pól.; 4,00 mm ² ; Zelená – žlutá, modrá, šedá	www.wago.com/769-113/000-039
	Obj. č.: 769-113/022-000 1 vodičová pružinová svorkovnice; Úhlové provedení; 4 mm ² ; 13pól.; 4,00 mm ² ; Šedá	www.wago.com/769-113/022-000
	Obj. č.: 769-114 1 vodičová pružinová svorkovnice; 4 mm ² ; 14pól.; 4,00 mm ² ; Šedá	www.wago.com/769-114
	Obj. č.: 769-114/000-006 1 vodičová pružinová svorkovnice; 4 mm ² ; 14pól.; 4,00 mm ² ; Modrá	www.wago.com/769-114/000-006
	Obj. č.: 769-114/000-036 1 vodičová pružinová svorkovnice; 4 mm ² ; 14pól.; 4,00 mm ² ; Šedá / zelená – žlutá	www.wago.com/769-114/000-036



Obj. č.: 769-114/000-037
1 vodičová pružinová svorkovnice; 4 mm²; 14pól.; 4,00 mm²; Zelená – žlutá / šedá

www.wago.com/769-114/000-037



Obj. č.: 769-114/000-038
1 vodičová pružinová svorkovnice; 4 mm²; 14pól.; 4,00 mm²; Šedá / modrá / zelená – žlutá

www.wago.com/769-114/000-038



Obj. č.: 769-114/000-039
1 vodičová pružinová svorkovnice; 4 mm²; 14pól.; 4,00 mm²; Zelená – žlutá, modrá, šedá

www.wago.com/769-114/000-039



Obj. č.: 769-114/022-000
1 vodičová pružinová svorkovnice; Úhlové provedení; 4 mm²; 14pól.; 4,00 mm²; Šedá

www.wago.com/769-114/022-000



Obj. č.: 769-115
1 vodičová pružinová svorkovnice; 4 mm²; 15pól.; 4,00 mm²; Šedá

www.wago.com/769-115



Obj. č.: 769-115/000-036
1 vodičová pružinová svorkovnice; 4 mm²; 15pól.; 4,00 mm²; Šedá / zelená – žlutá

www.wago.com/769-115/000-036



Obj. č.: 769-115/000-037
1 vodičová pružinová svorkovnice; 4 mm²; 15pól.; 4,00 mm²; Zelená – žlutá / šedá

www.wago.com/769-115/000-037



Obj. č.: 769-115/000-038
1 vodičová pružinová svorkovnice; 4 mm²; 15pól.; 4,00 mm²; Šedá / modrá / zelená – žlutá

www.wago.com/769-115/000-038



Obj. č.: 769-115/000-039
1 vodičová pružinová svorkovnice; 4 mm²; 15pól.; 4,00 mm²; Zelená – žlutá, modrá, šedá

www.wago.com/769-115/000-039



Obj. č.: 769-115/022-000
1 vodičová pružinová svorkovnice; Úhlové provedení; 4 mm²; 15pól.; 4,00 mm²; Šedá

www.wago.com/769-115/022-000

Carrier rail



Obj. č.: 210-112
Ocelová nosná lišta; 35 × 7,5 mm; Tloušťka 1 mm; Délka 2 m; Děrovaná; Dle normy EN 60715; Šířka otvorů 25 mm; vzdálenost mezi otvory 36 mm

www.wago.com/210-112

Obj. č.: 210-113
Ocelová nosná lišta; 35 × 7,5 mm; Tloušťka 1 mm; Délka 2 m; Neděrovaná; Dle normy EN 60715

www.wago.com/210-113

Obj. č.: 210-114
Ocelová nosná lišta; 35 × 15 mm; Tloušťka 1,5 mm; Délka 2 m; Neděrovaná; Podobné EN 60715

www.wago.com/210-114



Obj. č.: 210-115
Ocelová nosná lišta; 35 × 7,5 mm; Tloušťka 1 mm; Délka 2 m; Děrovaná; Dle normy EN 60715; Šířka otvorů 18 mm; vzdálenost mezi otvory 25 mm

www.wago.com/210-115















Obj. č.: 210-118
Ocelová nosná lišta; 35 × 15 mm; Tloušťka 2,3 mm; Délka 2 m; Neděrovaná; Dle normy EN 60715

www.wago.com/210-118

Obj. č.: 210-196
Hliníková nosná lišta; 35 × 8,2 mm; Tloušťka 1,6 mm; Délka 2 m; Neděrovaná; Podobné EN 60715; Stříbrná

www.wago.com/210-196

	Obj. č.: 210-197 Ocelová nosná lišta; 35 × 15 mm; Tloušťka 1,5 mm; Délka 2 m; Děrovaná; Podobné EN 60715	www.wago.com/210-197
	Obj. č.: 210-198 Měděná nosná lišta; 35 × 15 mm; Tloušťka 2,3 mm; Délka 2 m; Neděrovaná; Dle normy EN 60715; Měděná	www.wago.com/210-198
	Obj. č.: 210-504 Ocelová nosná lišta; 35 × 7,5 mm; Tloušťka 1 mm; Délka 2 m; Děrovaná; Pásově zinkováno; Dle normy EN 60715	www.wago.com/210-504
	Obj. č.: 210-505 Ocelová nosná lišta; 35 × 7,5 mm; Tloušťka 1 mm; Délka 2 m; Neděrovaná; Pásově zinkováno; Dle normy EN 60715	www.wago.com/210-505
	Obj. č.: 210-506 Ocelová nosná lišta; 35 × 15 mm; Tloušťka 1,5 mm; Délka 2 m; Neděrovaná; Pásově zinkováno; Podobné EN 60715	www.wago.com/210-506
	Obj. č.: 210-508 Ocelová nosná lišta; 35 × 15 mm; Tloušťka 1,5 mm; Délka 2 m; Děrovaná; Pásově zinkováno; Podobné EN 60715	www.wago.com/210-508
End plate		
	Obj. č.: 769-305 Koncová bočnice a separátor; Tloušťka 1,1 mm; Šedá	www.wago.com/769-305
	Obj. č.: 769-306 Koncová bočnice a separátor; Tloušťka 1,1 mm; Oranžová	www.wago.com/769-306
Jumper		
	Obj. č.: 249-123 Vodičový můstek; Izolováno; L = 180 mm; Průřez vedení 0,75 mm ²	www.wago.com/249-123
	Obj. č.: 249-125 Vodičový můstek; Izolováno; L = 60 mm; Průřez vedení 0,75 mm ²	www.wago.com/249-125
	Obj. č.: 249-126 Vodičový můstek; Izolováno; L = 110 mm; Průřez vedení 0,75 mm ²	www.wago.com/249-126
	Obj. č.: 249-127 Vodičový můstek; Izolováno; L = 250 mm; Průřez vedení 0,75 mm ²	www.wago.com/249-127
tools		
	Obj. č.: 210-720 Ovládací nástroj; Břit: 3,5 × 0,5 mm; S částečně izolovanou rukojetí	www.wago.com/210-720

Ke stažení**Documentation****Additional Information**

Technical explanations

03-Apr-2019

pdf
2,1 MB

Stáhnout

CAD/CAE-Data

CAD data

CAE data

Handling Instructions

Assembly

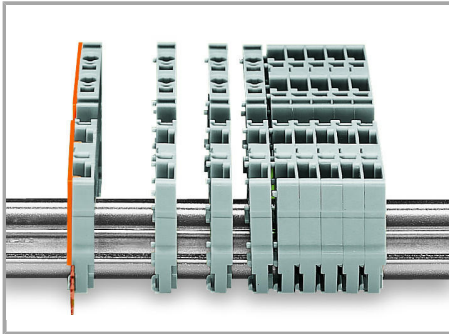

Snap individual carrier terminal blocks onto the carrier rail and slide together.

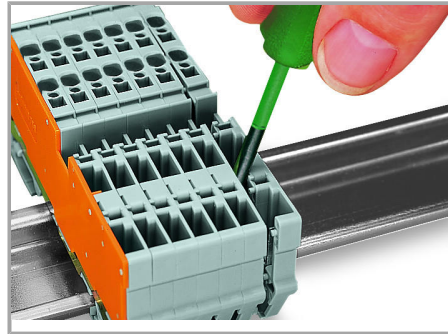

Open the assembly by laterally sliding a block via operating tool and remove terminal block via release lever.

Jumpered

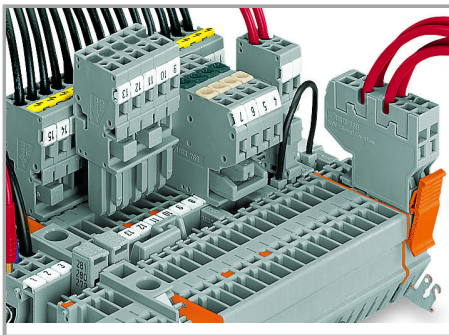

Commoning with adjacent or staggered jumpers –

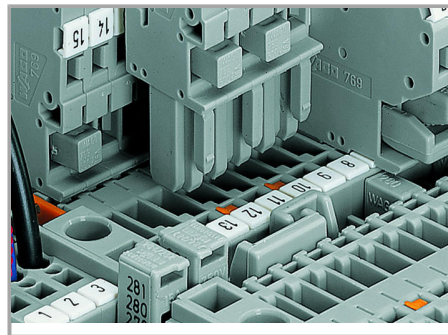

Commoning carrier terminal blocks via staggered jumpers.

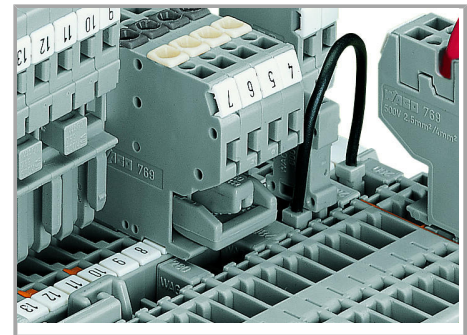

Commoning a 2-conductor female plug via staggered jumper and carrier terminal blocks via adjacent jumpers.

push jumpers down until fully inserted.

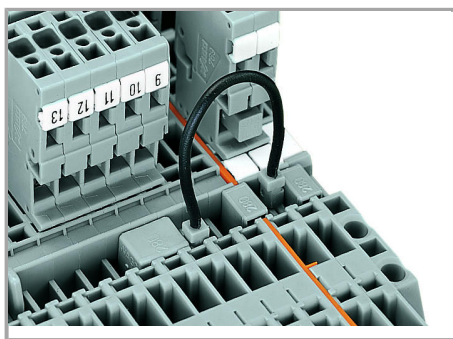

Commoning carrier terminal blocks via push-in type wire jumpers or adjacent jumpers – even over an intermediate plate.

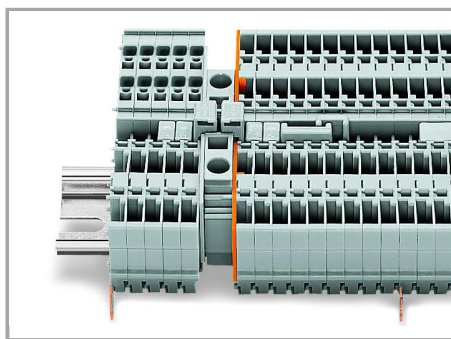

Commoning “supply terminal blocks” (up to 10 mm²/8 AWG) with carrier terminal blocks via step-down jumpers.

Testing

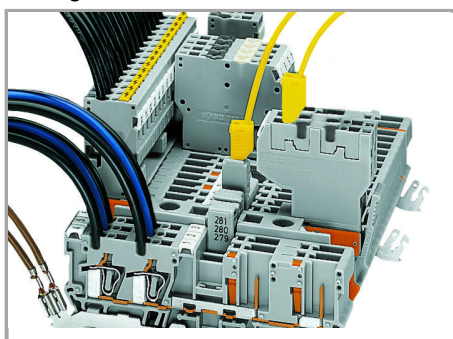

Testing via 2 or 2.3 mm Ø test plugs.

Coding

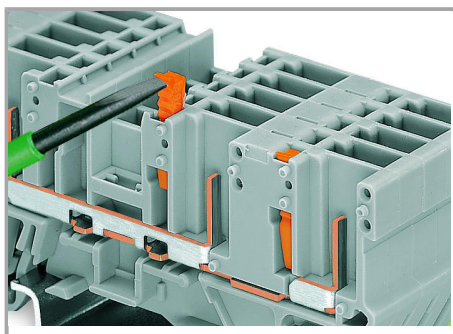

Snap coding pin in proper direction on carrier terminal block.

Shown: Coding pin removal from carrier terminal block.

Locking

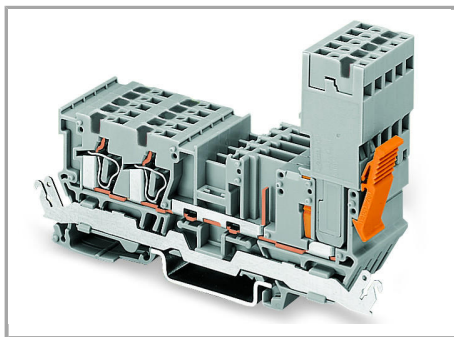

Female plug secured with locking lever on the terminal block side.

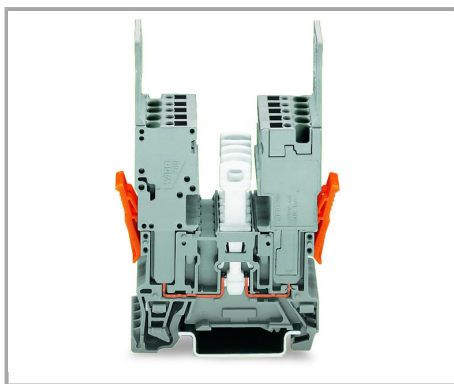

1-conductor female plug

Disconnect carrier terminal blocks cannot be commoned.

Produktová rodina

X-COM

[Zobrazit všechny produkty z rodiny](#)

Změny vyhrazeny.

WAGO Elektro spol. sr. o.
Rozvodova 1116/36
143 00 Praha 12 - Modřany
Tel.: +420 261 090 143
Email: info.cz@wago.com, wago-cz@wago.com

Máte otázky ohledně našich produktů?
Kdykoli nám zavolejte na číslo +420 261 090 143.