

DELIA 1AA,1A,1,2A,2,3,4,5 / DELIA C1A,C1,C2A,C2,C3,C4,C5

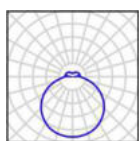

DELIA C  
dekorativní pás – černý mat

TECHNICKÁ DATA

Světelný zdroj	LED modul Osmont L10C, L12B, L12C, L14B, L14C, L16B, L16C, L17B, L20C, L51B, L52B, L53C	žárovka
Teplota chromatičnosti	3000K, 4000K	dle použitého zdroje
Index podání barev	3000K Ra>80, 4000K Ra>80	dle použitého zdroje
Životnost LED	50 000 hod / L80B10 (při okolní teplotě 25°C)	dle použitého zdroje
Proudový zdroj	Tridonic	-
Fotobiologická bezpečnost svítidla dle EN 62471 (Blue light hazard)	bezpečné (Risk group – 0)	dle použitého zdroje
Energetická třída	A++	dle použitého zdroje
Průvodní napětí	230V	
Stupeň krytí	IP44, IP54 (LED)	
Pracovní teplota	od -20°C do +30°C	
Odolnost proti nárazu	IK10 (stínítko PC)	
Záruka	5 let	
Montura	kovová	
Barevné provedení montury	bílá	
Materiál stínítka	opálový polykarbonát (PC), opálový polymethylmetakrylát (PM)	
Způsob držení stínítka	sklápovací držáky	
Montáž	na stěnu, na strop	
Použití	průmyslové prostory, chodby, venkovní osvětlení	

VARIANTY

LED:

Typové označení	Příkon [W]	Světelný tok LED [lm]		Světelný tok svítidla [lm]				Počet LED driverů	Možnost			
		3000K	4000K	3000K		4000K			Senzor (HF)	Stmívání (DALI)	Corridor (DALI+HF)	
				PC	PM	PC	PM					
DELIA 1AA	LED-1L10C03KN22/PC20_000	5	620	650	460	-	480	-	1	-	-	-
DELIA 1A	LED-1L12C03KN32/Px21_000	9	1080	1140	800	-	840	-	1	*	*	-
	LED-1L12B07KN32/Px21_000	11	1290	1350	950	-	1000	-	1	*	*!	-
DELIA C1A	LED-1L12C03KN32/Px21C_000	9	1080	1140	590	-	630	-	1	*	*	-
	LED-1L12B07KN32/Px21C_000	11	1290	1350	710	-	740	-	1	*	*!	-
DELIA 1	LED-1L14C03KN62/Px22_000	15	2000	2110	1480	1440	1560	1520	1	*	*	-
	LED-1L14B07KN62/Px22_000	20	2590	2700	1920	1860	2000	1940	1	*	*	-
DELIA C1	LED-1L14C03KN62/Px22C_000	15	2000	2110	1100	1100	1160	1160	1	*	*	-
	LED-1L14B07KN62/Px22C_000	20	2590	2700	1430	1430	1490	1490	1	*	*	-
DELIA 2A	LED-1L17B05KN73/PC19_000	19	2680	2800	1750	-	1830	-	1	*	*	*
	LED-1L17B07KN73/PC19_000	27	3590	3750	2350	-	2450	-	1	*	*	*
DELIA C2A	LED-1L17B05KN73/PC19C_000	19	2680	2800	1470	-	1540	-	1	*	*	*
	LED-1L17B07KN73/PC19C_000	27	3590	3750	1980	-	2060	-	1	*	*	*
DELIA 2	LED-1L16C07KN83/Px23_000	28	3690	3890	2580	2580	2720	2720	1	*	*	*
	LED-1L16B07KN83/Px23_000	36	4850	5070	3400	3400	3550	3550	1	*	*	*
DELIA C2	LED-1L16C07KN83/Px23C_000	28	3690	3890	2030	2030	2140	2140	1	*	*	*
	LED-1L16B07KN83/Px23C_000	36	4850	5070	2670	2670	2790	2790	1	*	*	*
DELIA 3	LED-1L20C07KN94/Px24_000	35	4750	5010	3140	3140	3310	3310	1	*	*	*
	LED-1L20C10KN94/Px24_000	53	6780	7150	4470	4470	4720	4720	1	*	*	*
DELIA C3	LED-3L53CT10KN94/Px24 2700-6500	53	6980*		4610*				1	-	-	-
	LED-1L20C07KN94/Px24C_000	35	4750	5010	2610	2610	2760	2760	1	*	*	*
	LED-1L20C10KN94/Px24C_000	53	6780	7150	3730	3730	3930	3930	1	*	*	*
DELIA 4	LED-3L53CT10KN94/Px24C 2700-6500	53	6980*		3840*				1	-	-	-
	LED-6L51B07KN10/PM25_000	68	10210	10670	-	6940	-	7260	2	-	*	-
	LED-6L51B10KN10/PM25_000	109	14790	15450	-	10060	-	10510	2	-	*	-
DELIA C4	LED-6L51B07KN10/PM25C_000	68	10210	10670	-	5620	-	5870	2	-	*	-
	LED-6L51B10KN10/PM25C_000	109	14790	15450	-	8140	-	8500	2	-	*	-
DELIA 5	LED-9L52B07KN11/PM26_000	104	15310	16000	-	10720	-	11200	3	-	*	-
	LED-9L52B10KN11/PM26_000	165	22180	23170	-	15530	-	16220	3	-	*	-
DELIA C5	LED-9L52B07KN11/PM26C_000	104	15310	16000	-	8420	-	8800	3	-	*	-
	LED-9L52B10KN11/PM26C_000	165	22180	23170	-	12200	-	12740	3	-	*	-

Px – stínítko PC nebo PM

.000 – 3000K nebo 4000K

\* – při 6500K

! – nelze ovládat tlačítkem (funkce SwitchDIM)

LED nouzové a nouzové kombinované:

	Typové označení	Příkon [W]	Světelný tok LED [lm]		Světelný tok svítidla [lm]				Světelný tok LED v nouzovém režimu		T [hod]	Typ akumulátoru
			3000K	4000K	3000K		4000K		[%]	[lm]		
					PC	PM	PC	PM				
DELIA 1A	LED-NZ1W/Px21_000	1	-	150	-	-	110	-	100	150	3	Ni-Cd (3,6V/1,5Ah)
DELIA C1A	LED-NZ1W/Px21C_000	1	-	150	-	-	100	-	100	150	3	Ni-Cd (3,6V/1,5Ah)
DELIA 1	LED-1L14C03KN62/Px22/NK1W_000	15	2000	2110	1480	1440	1560	1520	7	150	3	Ni-Cd (3,6V/1,5Ah)
	LED-1L14B07KN62/Px22/NK1W_000	20	2590	2700	1920	1860	2000	1940	6	150	3	Ni-Cd (3,6V/1,5Ah)
DELIA C1	LED-1L14C03KN62/Px22C/NK1W_000	15	2000	2110	1100	1100	1160	1160	7	150	3	Ni-Cd (3,6V/1,5Ah)
	LED-1L14B07KN62/Px22C/NK1W_000	20	2590	2700	1430	1430	1490	1490	6	150	3	Ni-Cd (3,6V/1,5Ah)
DELIA 2A	LED-1L17B05KN73/PC19/NK1W_000	19	2680	2800	1750	-	1830	-	5	150	3	Ni-Cd (3,6V/1,5Ah)
	LED-1L17B07KN73/PC19/NK1W_000	27	3590	3750	2350	-	2450	-	4	150	3	Ni-Cd (3,6V/1,5Ah)
DELIA C2A	LED-1L17B05KN73/PC19C/NK1W_000	19	2680	2800	1470	-	1540	-	5	150	3	Ni-Cd (3,6V/1,5Ah)
	LED-1L17B07KN73/PC19C/NK1W_000	27	3590	3750	1980	-	2060	-	4	150	3	Ni-Cd (3,6V/1,5Ah)
DELIA 2	LED-1L16C07KN83/Px23/NK1W_000	28	3690	3890	2580	2580	2720	2720	4	150	3	Ni-Cd (3,6V/1,5Ah)
	LED-1L16B07KN83/Px23/NK1W_000	36	4850	5070	3400	3400	3550	3550	3	150	3	Ni-Cd (3,6V/1,5Ah)
DELIA C2	LED-1L16C07KN83/Px23C/NK1W_000	28	3690	3890	2030	2030	2140	2140	4	150	3	Ni-Cd (3,6V/1,5Ah)
	LED-1L16B07KN83/Px23C/NK1W_000	36	4850	5070	2670	2670	2790	2790	3	150	3	Ni-Cd (3,6V/1,5Ah)
DELIA 3	LED-1L20C07KN94/Px24/NK1W_000	35	4750	5010	3140	3140	3310	3310	3	150	3	Ni-Cd (3,6V/1,5Ah)
	LED-1L20C10KN94/Px24/NK1W_000	53	6780	7150	4470	4470	4720	4720	2	150	3	Ni-Cd (3,6V/1,5Ah)
DELIA C3	LED-1L20C07KN94/Px24C/NK1W_000	35	4750	5010	2610	2610	2760	2760	3	150	3	Ni-Cd (3,6V/1,5Ah)
	LED-1L20C10KN94/Px24C/NK1W_000	53	6780	7150	3730	3730	3930	3930	2	150	3	Ni-Cd (3,6V/1,5Ah)

Px - stínitko PC nebo PM  
.000 - 3000K nebo 4000K

STANDARD:

	Typové označení	Příkon [W]	Objímka	Možnost
				Senzor (HF)
DELIA 1A	IN-12KN32/PC21	40	E27	• (1x30W)
DELIA C1A	IN-12KN32/PC21C	40	E27	• (1x30W)
DELIA 1	IN-12KN62/PC22	40	E27	• (1x30W)
	IN-12KN62/PM22	30	E27	• (1x20W)
DELIA C1	IN-12KN62/PC22C	40	E27	• (1x30W)
	IN-12KN62/PM22C	30	E27	• (1x20W)
DELIA 2A	IN-22KN73/PC19	2x40	2xE27	• (2x30W)
DELIA C2A	IN-22KN73/PC19C	2x40	2xE27	• (2x30W)
DELIA 2	IN-22KN83/PC23	2x40	2xE27	• (2x30W)
	IN-22KN83/PM23	2x30	2xE27	• (2x20W)
DELIA C2	IN-22KN83/PC23C	2x40	2xE27	• (2x30W)
	IN-22KN83/PM23C	2x30	2xE27	• (2x20W)
DELIA 3	IN-32KN94/PC24	3x40	3xE27	• (3x30W)
	IN-32KN94/PM24	3x30	3xE27	• (3x20W)
DELIA C3	IN-32KN94/PC24C	3x40	3xE27	• (3x30W)
	IN-32KN94/PM24C	3x30	3xE27	• (3x20W)
DELIA 4	IN-42KN10/PM25	4x30	4xE27	-
DELIA C4	IN-42KN10/PM25C	4x30	4xE27	-
DELIA 5	IN-62KN11/PM26	6x30	6xE27	-
DELIA C5	IN-62KN11/PM26C	6x30	6xE27	-

## PODSTAVEC

PRO POVRCHOVOU MONTÁŽ SVÍTIDLA – BOČNÍ PŘÍVOD

	PODSTAVEC
DELIA 1A	-
DELIA 1A,C1A	•
DELIA 1,C1	•
DELIA 2A,C2A	•
DELIA 2,C2	•
DELIA 3,C3	•
DELIA 4,C4	-
DELIA 5,C5	-

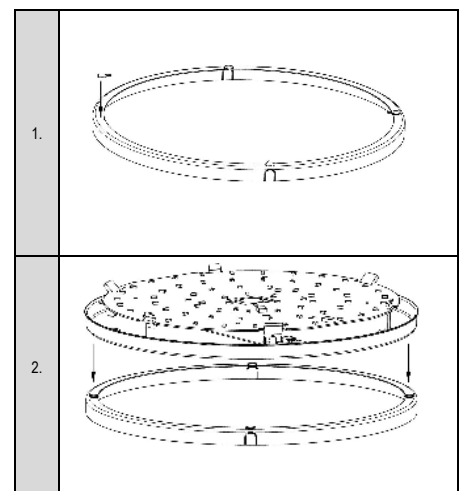
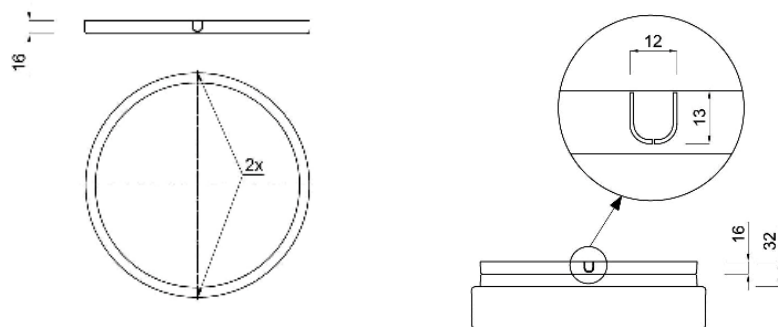

## ROZMĚRY

ROZMĚRY SVÍTIDLA [mm]:

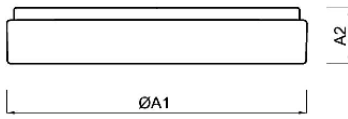

	ØA1	A2
DELIA 1AA	140	65
DELIA 1A,C1A	220	70
DELIA 1,C1	300	75
DELIA 2A,C2A	360	71
DELIA 2,C2	400	80
DELIA 3,C3	500	85
DELIA 4,C4	650	80
DELIA 5,C5	900	85

MONTÁŽNÍ ROZMĚRY [mm]:

DELIA 1AA		
DELIA 1A,C1A		
DELIA 1,C1		
DELIA 2A,C2A		

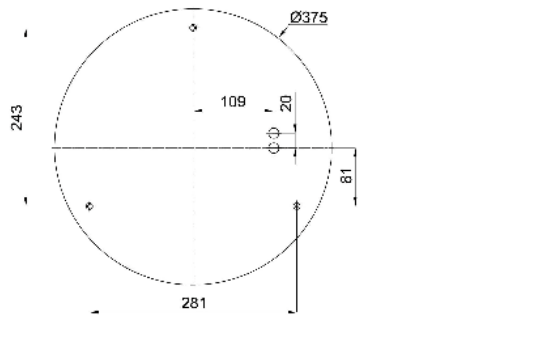
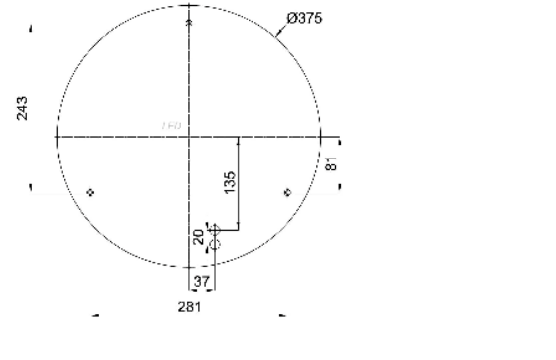
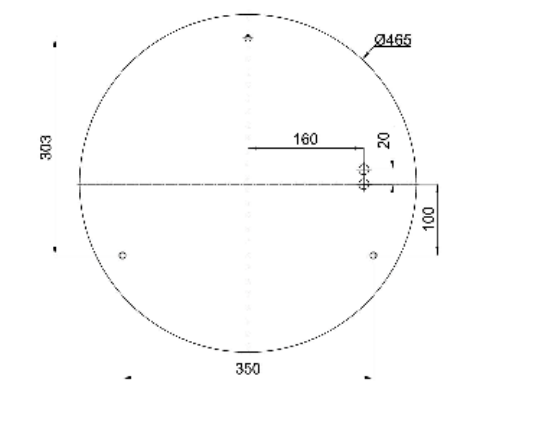
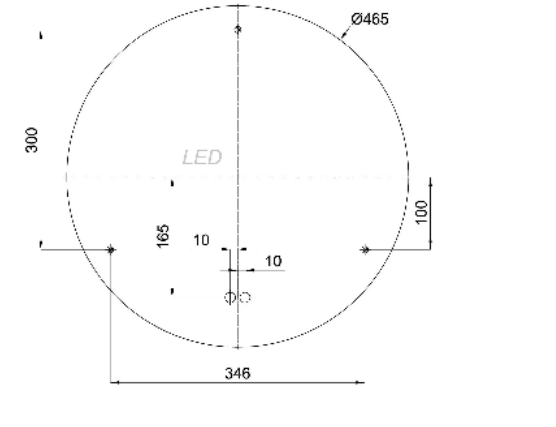
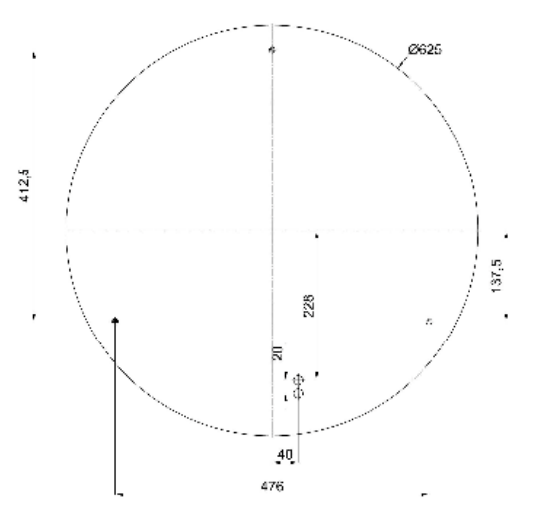
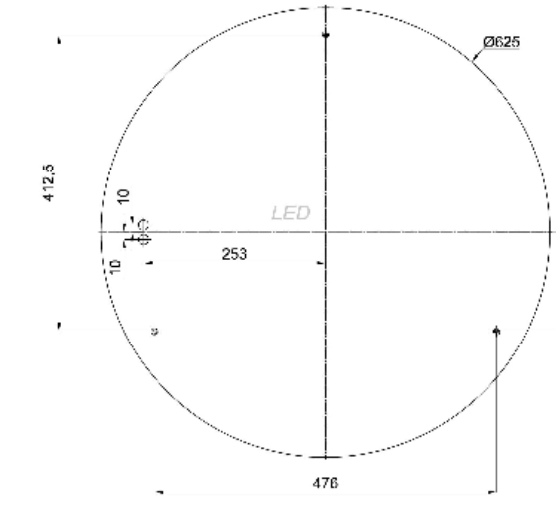
<p>DELIA 2,C2</p>	 <p>Ø375 243 109 20 81 281 IN-...</p>	 <p>Ø375 243 135 20 37 81 281 LED-...</p>
<p>DELIA 3,C3</p>	 <p>Ø465 303 160 20 100 350 IN-...</p>	 <p>Ø465 300 165 10 100 346 LED-...</p>
<p>DELIA 4,C4</p>	 <p>Ø625 412,5 228 20 137,5 40 476 IN-...</p>	 <p>Ø625 412,5 253 10 137,5 476 LED-...</p>

